



DEKOLIGHT

flairlight[®]
Innovative lighting

23
24



LIGHTING DESIGN AND 3D VISUALISATION

When it comes to private and commercial users, what really matters is not just the luminaire itself, but also how it illuminates the room (or an outdoor space). »What will the light look like?« – to help customers answer this question realistically and practically for customers in advance, we are now offering a special service and will take over the lighting design and lighting calculation for your project!

Are you interested?

Your contact person will be happy to explain the further procedure and answer any questions you may have.



draft planning



lighting effect in daylight



lighting effect with warm light

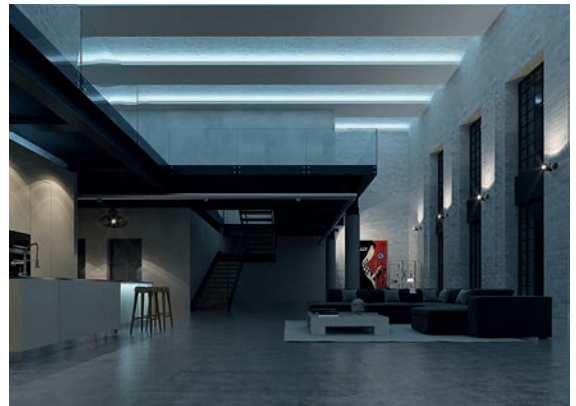

lighting effect with cold light



5 YEAR MANUFACTURER'S WARRANTY

All DEKO-LIGHT brand products come with a five-year extended warranty.

DEKO-LIGHT lighting solutions have always stood for maximum reliability and performance based on strict quality guidelines. For example, the products are regularly checked during the development and production process in order to provide users from all sectors with a fault-free product. The extension of the manufacturer's warranty underlines this quality promise once again.

- 04 highlight buttons | overview
- 06 new energy efficiency label
- 08 new products

INTERIOR LIGHTS

- 20 pendant lights
- 54 surface mounted ceiling lights
- 92 built in ceiling lights
- 148 insert panels
- 152 insert panels | backlight technology
- 158 insert panels | sidelight technology
- 166 surface mounted wall lights
- 186 built in wall lights
- 190 reading lights
- 196 table and floor lights
- 208 furniture lights
- 214 showcase lights
- 222 office lights
- 250 hall floodlight
- 258 damp-proof luminaires
- 268 emergency lights

POWER RAILS

- 278 D ONE 1-phase power rail system
- 292 1-phase power rail luminaires
- 300 D LINE 3-phase power rail system
- 328 3-phase power rail luminaires

BATTERY AND SOLAR LIGHTS

- 356 battery lights
- 370 solar lights

OUTDOOR LIGHTS

- 376 bollard lights
- 402 surface mounted wall lights
- 432 ceiling and wall lights
- 438 built in wall lights
- 446 spherical lamps
- 450 energy distributor
- 460 surface mounted and ground spike lights
- 472 wall washer
- 476 ground recessed lights
- 502 floodlight
- 512 display lights

PLANO

- 520 PLANO luminaire system
- 538 PLANO-profiles

ALUMINIUM PROFILES

- 548 linear light in 5 steps
- 550 aluminium profiles | overview
- 553 assembly for profiles and stripes
- 554 homogeneous light image
- 558 U-profiles | flat + high | built-in/built-on
- 570 T-profiles | flat + high | built-in
- 582 H- und groove-profiles
- 592 step/plinth/angle/corner-profiles | built-in/built-on
- 618 dry construction profiles
- 628 tile profiles
- 644 profiles for outdoor use | walkable/trafficable

LED STRIPES

- 656 LED stripes | overview
- 658 technical information
- 660 quick finder
- 664 COB | 1CH | 24V
- 668 COB sauna | 1CH | 24V
- 670 COB | 2CH | 24V
- 672 COB | 3CH | 24V
- 674 standard | 1CH | 12V / 24V / 48V
- 686 standard | 2CH | 12V / 24V
- 692 standard | 3CH | 24V / 48V
- 698 standard | 4CH | 24V
- 702 D FLEX LINE top-view | 1CH / 3CH / 4CH | 24V
- 710 D FLEX LINE side-view | 1CH / 4CH | 24V
- 716 230V | 1CH

POWER SUPPLIES

- 720 power supplies | overview
- 722 technical information
- 724 DC | CV | quick finder
- 728 DC | CV
- 740 DC | CC | quick finder
- 743 DC | CC
- 754 DC | CC/CV
- 756 AC | CV | quick finder
- 756 AC | CV

CONTROLLER

- 762 RF-smart
- 774 RF control
- 778 Casambi Bluetooth
- 780 quick finder | DMX controller
- 781 quick finder | DMX dimmer
- 782 DMX wall controller
- 786 DMX controller
- 788 DMX dimmer
- 792 DALI PWM dimmer

ILLUMINANTS

- 798 G4 | G53 QR111
- 799 MR16/GU5,3
- 800 G9 | GU10
- 802 E14
- 803 E27
- 806 R7s | GX53

ACCESSORIES

- 812 indoor | dimming and switching
- 813 indoor | other
- 814 indoor | low voltage
- 815 indoor | low voltage | plug-in connector
- 817 outdoor | low voltage DC | WEIPU HQ plug-in connector
- 820 indoor | DMX cable
- 823 indoor | high voltage
- 824 indoor | high voltage | plug systems
- 825 outdoor | high voltage | plug systems
- 827 outdoor | cable connectors
- 830 indoor / outdoor | mounting material for LED stripes and profiles
- 831 outdoor | mounting accessories
- 837 indoor / outdoor | chemical products

- 834 lighting solutions
- 846 technical information
- 852 legend
- 854 index

EVERYTHING IN VIEW

With our new highlight buttons, you can see at a glance which functions and highlights a luminaire offers. Here you will find all buttons at a glance.



LIGHT COLOURS / CHANNELS

Depending on the LED equipment, different colours can be mixed with the luminaire via the individual RGB channels. Luminaires with RGBW equipment also contain single-colour white LEDs in the light colours warm white [WW], cool white [CW] or neutral white [NW].



HCL

HCL stands for "Human Centric Lighting" and means the tuning of artificial light indoors to natural daylight and the human biorhythm. HCL-capable luminaires can be integrated into an HCL control system and their light colour can be adjusted.



LIGHT COLOUR SELECTABLE

Luminaires with the designation "CCT Dip" can be changed in light colour via a dip switch on the housing and can thus be used particularly flexibly. The range usually extends from warm white [3,000K] to neutral white [4,000K] to cool white [5,000K].



DIM TO WARM

The dim-to-warm function automatically adjusts the light colour when a luminaire is dimmed. The rule is: the lower the luminous intensity, the warmer the light colour. In this way, luminaires with dim-to-warm technology flexibly adapt to the mood of the room.



BEG ELIGIBLE

Eligible luminaires under the BEG programme [Federal funding for efficient buildings] have a system luminous efficacy of at least 120 lm/W [140 lm/W for LED strips] and a service life of 50,000 hours at L80 [80 % luminosity].



SUITABLE FOR VDU WORKSTATIONS

These luminaires meet the requirements of DIN standard EN 12464-1 according to the lighting of indoor workplaces. With a luminance value of $L_{65} < 3000 \text{ cd/m}^2$, the luminaires are standard-compliant for glare-free VDU workstations.



PASSABLE

Drive-on recessed luminaires are generally used outdoors and can withstand particularly high pressure loads from pedestrians, vehicles and other objects. Drive-in luminaires have an IP protection of at least IP67.



FSC CERTIFIED

FSC® ["Forest Stewardship Council®"] is an international certification system. Luminaires with FSC® certification use only wood from sustainable forestry and can demonstrate a sustainable value chain in this respect.



THROUGH-WIRING POSSIBLE

This luminaire enables through-wiring and can be connected in series with other luminaires. The advantage: luminaires with through-wiring require only one power connection, eliminating the need for costly laying of additional cables.



CONTROLLABLE VIA ...

The luminaire can be controlled via one of the following lighting control systems: RF smart [the new control system from DEKO-LIGHT for up to eight light zones], zigbee, DALI, RF [Radio Frequency], Bluetooth, WiFi.



IP PROTECTION

The IP protection class indicates the protection of live parts against the ingress of foreign bodies and contact [first digit] and against water [second digit] with two digits. The following applies: The higher the respective digit, the higher the protection.



UGR

The UGR value indicates how glare-free a luminaire is, thus avoiding disturbing reflections. The lower the UGR value, the more glare-free a luminaire emits its light. Luminaires with a UGR value < 19 are suitable for office environments and workplaces.



IK IMPACT RESISTANCE

The IK value [or IK impact resistance level] indicates how shock and impact resistant a luminaire or certain components of the luminaire are. The following applies: The higher the IK value [IK00 to IK10+], the greater the protection against external mechanical stress.



COLOUR RENDERING INDEX RA

The colour rendering index Ra describes the measure of the correspondence of the perceived light colour between an existing lighting situation and a reference light source. The higher the Ra value, the better/natural the colour rendering.



COLOUR CONSISTENCY SDCM

The SDCM value describes the standard deviation of an LED from the target colour location and is a measure of production-related colour differences between LEDs with identical values. The higher the value, the greater the colour deviation. The maximum valid deviation is 6 SDCM.



POWER SWITCH

Luminaires with an integrated power switch can be switched in wattage and operated in several power levels. The power reduction enables flexible adjustment of the light intensity and is usually carried out via a dip switch on the unit.



TOOL-FREE INSTALLATION

These luminaires are delivered with pre-assembled components and can be mounted without additional tools. This saves time during installation and enables particularly simple and efficient conversion in the event of renovation or refurbishment.

Further information on specific light values and functions can be found from page 846.

THE NEW ENERGY EFFICIENCY CLASSES

The new energy efficiency classes A to G are among the most important requirements of the new EU Ecodesign Directive 2021. We explain what the new energy labels mean.

The European Union's Ecodesign Directive was already adopted in 2009 and has been in force since September 2021. This goes hand in hand with a new scale for determining the energy efficiency value: the previous classification from A+++ to E gives way to a new gradation from A to G. The original scale was intended to distinguish particularly energy-friendly lighting solutions, primarily LED-based. The reason: the original scale was intended to distinguish particularly energy-friendly lighting solutions, primarily LED-based. However, due to great technical progress, even the cheapest LED lamps gradually fell into the A classification, which ran counter to the original purpose [consumer benefit].

The new energy efficiency classes are now strictly based on the luminous efficacy of a light source. Thus, only luminaires with 210 lm/W receive the A label; luminaires with less than 85 lm/W fall into class G. Good to know: The EU's new energy labels have been classified with an eye to the future. Thus, the upper classes A and B remain free for the time being so that manufacturers have leeway for further technological advances without the need to adapt the energy label again in the near future.

In addition to the new energy efficiency classes, manufacturers of artificial lighting are subject to numerous other new requirements. With the expansion of our measurement laboratory, we are already taking these requirements into account and verifying compliance with the specified limit values for stroboscopic effects and light flicker for each product concerned.

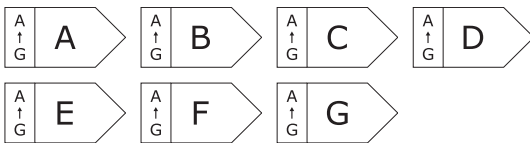

representation in the catalogue



What is the Ecodesign Directive?

The European Union's Ecodesign Directive 2021 includes numerous regulations for various electronics sectors and serves to prevent waste or increase resource efficiency. In this context, the directive regulates the longer and faster availability of spare parts in order to make products more repairable and retrofittable and thus more sustainable. At the same time, a European data room is to be created for the central bundling of product information. Under the keyword "digital product passport", information on materials, spare parts or also on proper disposal is to be summarised in the future and used for all phases along the product life cycle.

further information: ec.europa.eu



Foto: Daniel Wieser - Architektur fotografie, Karlsruhe

ACRUX 68



Using the ACRUX 68 recessed ceiling luminaire as an example, we show the new classification in the new future-proof scale – the product still has the same efficiency! All information on the ACRUX series can be found from page 110.



PLANO

The PLANO series is more than just another combination of profile and LED stripe and is produced entirely in Europe. The linear lighting solutions are based on four different profiles with LED equipment, surrounded by an aluminium corpus. PLANO can be individually configured in terms of length, lamps, colour temperature and body design. There are thus hardly any limits to the possible applications - whether in offices, schools, private homes, shops, showrooms and many more.

- individually plannable
- flexible in use
- manufactured in Europe

All information on the PLANO series can be found from page 518 onwards.





D ONE

D ONE is the new 1-phase system from DEKO-LIGHT and is based on two components: the surface-mounted track system and the luminaires. The compact tracks are more filigree than 3-phase systems and are not only suitable for bars and shops but also for flexible use in the home. The components include various feeders, connectors and adapters and allow for a variety of designs in any room.

- slimmer and more decorative than 3-phase systems
- extensive choice of components
- diverse design options

All information on the D ONE system can be found from page 276 onwards.



MADERA

MADERA is a modern luminaire family made of FSC-certified European oak wood of grade A and thus from sustainable forestry. The series includes a pendant, ceiling, wall and table/standing luminaire and with its modern, natural appearance fits into private living areas as well as hotels, restaurants and other environments.

- modern design
- FSC-certified raw material
- manufactured in Europe

All information on the MADERA series can be found on pages 52, 90, 184 and 206.





DIONE

With its particularly low installation depth, the DIONE series is a real problem solver in the refurbishment sector. The 30° swivelling aluminium ceiling spots with high-quality COB LED including reflector have a cut-out dimension of 68 mm and require only 25 mm ceiling cavity for installation. The power supply unit and the Quick connection box for optional through-wiring of several DIONE spots and simple subsequent assembly in the context of refurbishments are located in this space.

- shallow installation depth [25mm]
- incl. power supply unit and connection box
- through-wiring possible
- IP44 version for wet areas

All information on the DIONE series can be found from page 124 onwards.

OFFICE THREE SERIE

The new OFFICE THREE office free-standing luminaires have been improved in all respects. In addition to the expanded sensor system including a high-frequency presence detector, the downward direct light now works with full-spectrum LEDs for particularly high light quality [UGR<6, SDCM <3] and enables the illumination of desks of up to 160 x 80 cm. In addition, the indirect light is significantly more powerful, so that the room can be brightened up more than before by the free-standing luminaire. For height-adjustable desks, we also offer the OFFICE THREE as a version without a stand. In this case, the luminaire is attached to the desk using a desk clamp.

- suitable for computer workstations according to EN 12464-1 BAP65
- also for height-adjustable desks
- BEG-eligible

All information on the OFFICE THREE series can be found from page 242 onwards.



FARO

The solid FARO bollard luminaires made of die-cast aluminium are available in sizes of 25, 60 and 100 cm and, with their design (more than 97% downward light) and lens optics, ensure glare-free light distribution and a particularly large light cone with a diameter of up to 10 metres. In addition to a DALI 2-dimmable version, the FARO models can be equipped with an optional shielding screen to illuminate areas only on one side.

- glare-free light
- lens optics for homogeneous illumination
- optional shielding screen

All information on the FARO can be found from page 398 onwards.



CANIS

The CANIS table luminaire series is aimed at home users and commercial customers and leaves nothing to be desired in terms of appearance with its eight colour versions. Depending on the application, the pleasant, flat light of the CANIS can be switched between two light colours [2,700/3,000K] and dimmed continuously via touch sensor. Charging is via an optional USB charging base. Primarily for commercial users, there is also a stackable 6-compartment charging station with its own power supply unit for six luminaires.

- eight colours
- infinitely dimmable
- large light cone

All information on the CANIS can be found from page 362 onwards.



RF-SMART

The in-house RF-smart control system offers modern smart home functions and outdoor compatibility for controlling up to eight light zones. In addition to switching and dimming devices with 230V mains voltage, controllers are available for controlling LED strips with 1-5 channels and 12-48V. Control is via battery-operated RF remote controls or via push-buttons of the existing electrical installation. RF-smart is compatible with the most important smart home solutions such as Alexa, Google Assistant, Tuya and more.



- up to 8 RF zones
- 230V switching/dimming
- control LED stripes 12V-48V
- outdoor compatible [IP65/67]

All information on RF-smart can be found from page 762.



TRI PROOF BASIC

The TRI PROOF BASIC moisture-proof diffuser luminaires have proven themselves for years as extremely reliable industrial and task luminaires that impress not only with their robust construction and long service life [50,000h L80B50], but also with their high energy efficiency [BEG-eligible]. In practice, the pre-installed through-wiring and cable entries on the rear ensure simplified installation. In addition, we also offer the TRI PROOF BASIC with an integrated, adjustable motion detector.

- BEG-eligible
- particularly energy-efficient
- through-wiring [DALI]

All information on TRI PROOF BASIC can be found from page 260 onwards.



VEGA

The high-quality VEGA high-bay luminaires impress with their light output, energy efficiency [BEG-eligible] and flexibility for the illumination of workplaces of any size. In addition to the three levels of adjustable light output, the spotlights can also be equipped with an optional lens for glare control [UGR<19] at desks, workstations and other workplaces. Various suspension sets and a wall-mounting arm are available for flexible assembly.

- power adjustable in three stages
- particularly energy-efficient
- BEG-eligible
- UGR<19 with optional lens

All information on VEGA can be found from page 252 onwards.



INTERIOR LIGHTS

- 20 pendant lights
- 54 surface mounted ceiling lights
- 92 built in ceiling lights
- 148 insert panels
- 152 insert panels | backlight technology
- 158 insert panels | sidelight technology
- 166 surface mounted wall lights
- 186 built in wall lights
- 190 reading lights
- 196 table and floor lights
- 208 furniture lights
- 214 showcase lights
- 222 office lights
- 250 hall floodlight
- 258 damp-proof luminaires
- 268 emergency lights



□ □ □
■ ■ ■
page 23



□ □ □
page 25



□ □
page 25



□ □ □
page 26



□ □
page 29



□ □
page 30



□ □
page 31



■
page 32



■
page 32



□
page 33



■
page 33



■ ■
page 34



■ ■
page 34



□ □
page 36



□
page 39



□
page 39



□
page 41



□
page 41



■ □ □
page 42



■ □ □
page 42



□ □ ■
□ □
page 45



□ □ ■
□ □
page 47

pendant lights



□ ■ □
page 49



□ ■ □
page 51



■ □
page 52





DIVERSITY

As colourful as life itself - with DIVERSITY we set an example for more colour and diversity. The pendant luminaire series based on a patented design by Johannes Tomm offers a choice of seven colours and can be combined as desired. With a cable length of 3 metres, DIVERSITY is also convincing in high rooms. The retrofit compatibility with all E27 light sources of the A60 design allows even more variety.



DIVERSITY

- Design by Johannes Tomm
- wide range of colours
- dimensions L x Ø: 200 x 280 mm
- socket H x Ø: 25 x 100 mm
- max. suspension: 3000 mm
- dimmable via optional illuminants

item	colour	price
342170	 white	84,95 €
342172	 grey	84,95 €
342171	 black	84,95 €
342173	 red	84,95 €
342174	 yellow	84,95 €
342175	 blue	84,95 €
342176	 green	84,95 €



suitable illuminants on page 803-805



ASTEROPE

Light & shadow: Hardly any luminaire embodies this dualism more beautifully than the ASTEROPE in its various versions. The downward-opening pendant luminaire creates a multifaceted play of light and shadow on walls and ceilings that blends extravagantly yet harmoniously into any ambience.

ASTEROPE ROUND

- metal
- socket H x Ø: 25 x 120 mm
- max. suspension: 1095 mm
- dimmable via optional illuminants

item	colour	dimensions L x Ø	power	price
342129	□ white	1400 x 250 mm	1x max. 40 W	99,95 €
342132	■ black	1400 x 250 mm	1x max. 40 W	99,95 €
342130	□ white	1500 x 400 mm	1x max. 40 W	209,95 €
342133	■ black	1500 x 400 mm	1x max. 40 W	209,95 €
342131	□ white	1600 x 500 mm	3x max. 40 W	319,95 €
342134	■ black	1600 x 500 mm	3x max. 40 W	319,95 €



suitable illuminants on page 803-805



ASTEROPE LINEAR

- metal
- dimensions L x H x Ø: 1500 x 300 x 150 mm
- socket H x Ø: 25 x 120 mm
- max. suspension: 1175 mm
- dimmable via optional illuminants

item	colour	price
342135	□ white	99,95 €
342136	■ black	99,95 €



suitable illuminants on page 803+805



suitable
wall lights
page 170
341216
341217



suitable
table /
floor lights
page 204
346003
346004
343020
343021

LUCEA

The pendant luminaires of the LUCEA series are available in the versions 10, 15, 20 W and offer up to 2,000 lumens of light output. The maximum suspension is 1,800 mm. Via optional lenses, the various models can be narrowed or widened in their angle of radiation. The housing of the LUCEA luminaires is made of aluminium diecast.

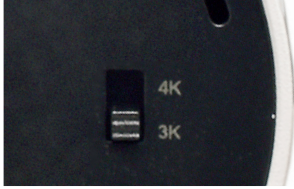

suitable surface
mounted ceiling
lights
from page 83
348153
348154
348161
348162



suitable
power
luminaires
1 phase
from page 294
707165-707168
707175-707178



suitable
power
luminaires
3 phases
from page 344
707116
707117
707124
707125

LUCEA 10

- aluminium diecast
- dimensions H x Ø: 157 x 65 mm
- socket H x Ø: 29 x 104,5 mm
- max. suspension: 1800 mm
- dimmable via phase control or phase cut-off
- light colour adjustable via dip switch
- incl. black reflector ring

item	colour	colour temperature	light current	price
342177	□ white	WW NW 3000 / 4000 K	930 / 1000 lm	139,95 €
342178	■ black	WW NW 3000 / 4000 K	930 / 1000 lm	139,95 €

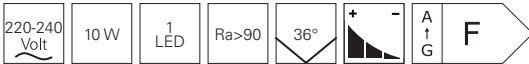

accessories

930679	lens 24° for LUCEA 6/10	9,95 €
930752	barn door for LUCEA 6/10 white	22,95 €
930753	barn door for LUCEA 6/10 black	22,95 €
930756	reflector ring for LUCEA 6/10 white	4,95 €
930757	reflector ring for LUCEA 6/10 black	4,95 €
930758	reflector ring for LUCEA 6/10 gold	4,95 €



suitable surface
mounted ceiling
lights
from page 84
348155-348158
348163-348166



suitable
power
luminaires
from page 345
707118-707121
707126-707129

LUCEA 15 + 20

- aluminium diecast
- dimensions H x Ø: 178 x 85 mm
- socket H x Ø: 29 x 104,5 mm
- max. suspension: 1800 mm
- dimmable via phase control or phase cut-off
- light colour adjustable via dip switch
- incl. black reflector ring

item	colour	colour temperature	light current	power	price
342179	<input type="checkbox"/> white	<input type="checkbox"/> WW <input type="checkbox"/> NW 3000 / 4000 K	1460 / 1500 lm	15 W	159,95 €
342180	<input checked="" type="checkbox"/> black	<input type="checkbox"/> WW <input type="checkbox"/> NW 3000 / 4000 K	1460 / 1500 lm	15 W	159,95 €
342181	<input type="checkbox"/> white	<input type="checkbox"/> WW <input type="checkbox"/> NW 3000 / 4000 K	1930 / 2000 lm	20 W	179,95 €
342182	<input checked="" type="checkbox"/> black	<input type="checkbox"/> WW <input type="checkbox"/> NW 3000 / 4000 K	1930 / 2000 lm	20 W	179,95 €



accessories

930680	lens 24° for LUCEA 15/20	12,95 €
930681	lens 60° for LUCEA 15/20	12,95 €
930754	barn door for LUCEA 15/20 white	23,95 €
930755	barn door for LUCEA 15/20 black	23,95 €
930759	reflector ring for LUCEA 15/20 white	5,95 €
930760	reflector ring for LUCEA 15/20 black	5,95 €
930761	reflector ring for LUCEA 15/20 gold	5,95 €



SLIM

The luminaires of the SLIM series include single-flame, three-flame pendant luminaires and matching pendant luminaires for the DEKO-LIGHT track light system. The luminaire body made of die-cast aluminium is always the same size [300 x 39mm]. With this, several SLIM models can be combined with each other in larger rooms. The pendant luminaires for ceiling installation with a maximum suspension of 180 cm are available as single- and three-lamp versions, the three-lamp version with either an elongated or round base, depending on the arrangement of the luminaires.

While the fixed SLIM models immerse dining tables, reading corners and more in a pleasant warm white light, the single-lamp SLIM track luminaire is particularly suitable for restaurant and retail projects with changing room layouts. A flexible textile cable underlines the quality of the SLIM series.



suitable
power
luminaires
1 phase
page 296
707164
707163



suitable
power
luminaires
3 phases
page 351
707133
707132

SLIM RUND

- particularly soft textile cable
- glare-free thanks to low UGR value [<19]
- slim design with a diameter of only 39 mm
- aluminium diecast
- dimensions H x \varnothing : 300 x 39 mm
- socket H x \varnothing : 25 x 100 mm
- max. suspension: 1800 mm
- incl. silver-coloured reflector ring

item	colour	colour temperature	light current	control	price
342238	<input type="checkbox"/> white	2700 K	500 lm	dimmable	84,95 € NEW
342237	<input checked="" type="checkbox"/> black	2700 K	500 lm	dimmable	84,95 € NEW
342214	<input type="checkbox"/> white	3000 K	500 lm		79,95 €
342213	<input checked="" type="checkbox"/> black	3000 K	500 lm		79,95 €

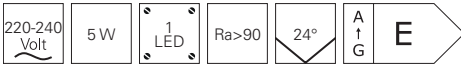

accessories

930747	lens 15°	4,95 €
930748	lens 36°	4,95 €
930749	lens 60°	4,95 €
930744	reflector ring white	4,95 €
930745	reflector ring black	4,95 €
930746	reflector ring gold	5,95 €



SLIM ROUND

- particularly soft textile cable
- glare-free thanks to low UGR value [<19]
- slim design with a diameter of only 39 mm
- aluminium diecast
- dimensions H x \varnothing : 300 x 39 mm
- socket H x \varnothing : 240 x 25 mm
- max. suspension: 1800 mm
- incl. silver-coloured reflector ring

item	colour	colour temperature	light current	control	price
342242	white	2700 K	3x 500 lm	dimnable	209,95 € NEW
342241	black	2700 K	3x 500 lm	dimnable	209,95 € NEW
342218	white	3000 K	3x 500 lm		199,95 €
342217	black	3000 K	3x 500 lm		199,95 €



suitable
power
luminaires
1 phase
page 296
707164
707163



suitable
power
luminaires
3 phases
page 351
707133
707132

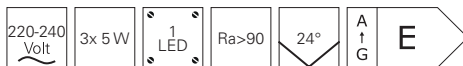

accessories

930747	lens 15°	4,95 €
930748	lens 36°	4,95 €
930749	lens 60°	4,95 €
930744	reflector ring white	4,95 €
930745	reflector ring black	4,95 €
930746	reflector ring gold	5,95 €



SLIM EDGED

- particularly soft textile cable
- glare-free thanks to low UGR value [<19]
- slim design with a diameter of only 39 mm
- aluminium diecast
- dimensions H x \varnothing : 300 x 39 mm
- socket L x B x H: 370 x 80 x 26 mm
- max. suspension: 1800 mm
- incl. silver-coloured reflector ring



suitable
power
luminaires
1 phase
page 296
707164
707163



suitable
power
luminaires
3 phases
page 351
707133
707132

item	colour	colour temperature	light current	control	price
342240	<input type="checkbox"/> white	2700 K	3x 500 lm	dimmable	209,95 € NEW
342239	<input checked="" type="checkbox"/> black	2700 K	3x 500 lm	dimmable	209,95 € NEW
342216	<input type="checkbox"/> white	3000 K	3x 500 lm		199,95 €
342215	<input checked="" type="checkbox"/> black	3000 K	3x 500 lm		199,95 €

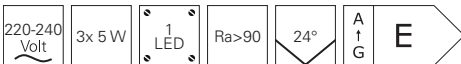

accessories

930747	lens 15°	4,95 €
930748	lens 36°	4,95 €
930749	lens 60°	4,95 €
930744	reflector ring white	4,95 €
930745	reflector ring black	4,95 €
930746	reflector ring gold	5,95 €

POLARIS

- concrete
- dimensions L x B x H: 70 x 70 x 250 mm
- socket L x B x H: 80 x 80 x 30 mm
- max. suspension: 1200 mm
- dimmable via optional illuminants

item	colour	price
342095	 grey	74,95 €



suitable illuminants on page 800+801



POLLUX

- concrete
- dimensions H x Ø: 250 x 70 mm
- socket H x Ø: 35 x 90 mm
- max. suspension: 1200 mm
- dimmable via optional illuminants

item	colour	price
342096	 grey	74,95 €



suitable illuminants on page 800+801





BARRO II

- gypsum paintable
- dimensions H x Ø: 250 x 70 mm
- socket H x Ø: 31 x 70 mm
- max. suspension: 1200 mm
- dimmable via optional illuminants

item	colour	price
342024	<input type="checkbox"/> white	69,95 €



suitable illuminants on page 800+801



CONCRETO I

- concrete
- dimensions H x Ø: 188 x 188 mm
- socket H x Ø: 25 x 120 mm
- max. suspension: 1600 mm
- dimmable via optional illuminants

item	colour	price
342128	<input checked="" type="checkbox"/> grey	79,95 €



suitable illuminants on page 803-805

PAVONIS & CYGNI

concrete – a timeless companion. In the meantime, the functional and visual advantages of this ubiquitous material have also reached the lighting industry. Due to the stability of concrete, even large luminaires can be built narrowly. Our PAVONIS & CYGNI models combine the timelessly modern concrete look with elegant brass or chrome surfaces.

PAVONIS

- concrete
- dimensions H x Ø: 199 x 140 mm
- socket H x Ø: 25 x 120 mm
- max. suspension: 1500 mm
- dimmable via optional illuminants

item	colour	price
342103	grey	64,95 €
342104	dark grey	64,95 €



suitable illuminants on page 803-805



CYGNI

- concrete
- dimensions H x Ø: 285 x 400 mm
- socket H x Ø: 25 x 120 mm
- max. suspension: 1500 mm
- dimmable via optional illuminants

item	colour	price
342101	grey	119,95 €
342102	dark grey	119,95 €



suitable illuminants on page 803-805





TWISTER

Elegant design with innovative details meets exceptional choice of materials: The TWISTER series combines decorative floor, table and pendant luminaires in different sizes, made entirely of plaster. We turn the cable into a design element! Entirely in classic white, the luminaires are only interrupted by a red cable. This makes the TWISTER series an eye-catcher not only in living areas, but also in hotels or restaurants.

TWISTER I

- Design by Johannes Tomm
- red textile cable
- gypsum paintable
- easy cleaning through surface treatment
- dimensions H x Ø: 185 x 180 mm
- socket H x Ø: 25 x 120 mm
- max. suspension: 3000 mm
- dimmable via optional illuminants

item	colour	price
342144	<input type="checkbox"/> white	79,95 €



suitable illuminants on page 802



TWISTER II

- Design by Johannes Tomm
- red textile cable
- gypsum paintable
- easy cleaning through surface treatment
- dimensions H x Ø: 282 x 280 mm
- socket H x Ø: 25 x 120 mm
- max. suspension: 3000 mm
- dimmable via optional illuminants

item	colour	price
342145	<input type="checkbox"/> white	119,95 €



suitable illuminants on page 803-805







ELECTRA

Could it be any cooler? Sure – ELECTRA! The combination of silver-coloured chrome lampshade and modern LED technology underlines modern interiors and serves as an elegant eye-catcher above tables and other furniture.

But don't worry: with its warm light colour, ELECTRA creates a cosy, warm atmosphere.



in the off-state



in the on-state



ELECTRA

- glass
- dimensions Ø: 115 mm
- socket H x Ø: 25 x 100 mm
- max. suspension: 1200 mm
- dimmable via phase control or phase cut-off

item	colour	colour temperature	light current	price
342116	 silver coloured chrome	 3000 K	180 lm	109,95 €



ELECTRA

- glass
- dimensions Ø: 115 mm
- socket L x B x H: 610 x 75 x 25 mm
- max. suspension: 1200 mm
- dimmable via phase control or phase cut-off

item	colour	colour temperature	light current	price
342117	 silver coloured chrome	 3000 K	540 lm	209,95 €

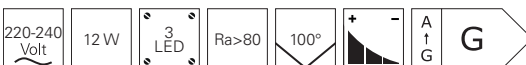



in the off-state



in the on-state

BUNDA

- glass
- dimensions Ø: 135 mm
- socket H x Ø: 25 x 100 mm
- max. suspension: 1200 mm
- dimmable via optional illuminants

item	colour	price
342114	 silver coloured chrome	64,95 €



suitable illuminants on page 800



BUNDA

- glass
- dimensions Ø: 135 mm
- socket L x B x H: 610 x 75 x 25 mm
- max. suspension: 1200 mm
- dimmable via optional illuminants

item	colour	price
342115	 silver coloured chrome	144,95 €



suitable illuminants on page 800





BARREL

Full focus: The BARREL and BELL pendant luminaires concentrate entirely on their most important task - illuminating a specific area. This is not least due to the noble metal shade, which ensures glare-free lighting pleasure throughout.

BARREL

- metal
- dimensions L x Ø: 250 x 100 mm
- socket H x Ø: 25 x 120 mm
- max. suspension: 1000 mm
- dimmable via optional illuminants

item	colour	price
342049	 copper coloured	79,45 €
342050	 silver coloured satined	79,45 €
342051	 black	79,45 €





suitable illuminants on page 803+805



BELL

- metal
- dimensions L x Ø: 300 x 300 mm
- socket H x Ø: 25 x 120 mm
- max. suspension: 1000 mm
- dimmable via optional illuminants

item	colour	price
342052	 copper coloured	119,95 €
342053	 silver coloured satined	119,95 €
342054	 black	119,95 €



suitable illuminants on page 803-805









MENKAR 400 + 600 + 800

- timeless, minimalist design
- high light current [indirect light component ca. 15 - 20%]
- aluminium
- socket H x Ø: 30 x 100 mm
- light colour adjustable via dip switch
- dimmable via phase control or phase cut-off



suitable
ceiling lights
page 59
348198-348209

item	colour	colour temperature	light current	dimensions H x Ø	max. suspension	power	price
342201	white	3000/4000 K	3100/3200 lm	60 x 400 mm	1800 mm	43 W	239,95 €
342203	silver brushed	3000/4000 K	3100/3200 lm	60 x 400 mm	1800 mm	43 W	239,95 €
342204	coffee brushed	3000/4000 K	3100/3200 lm	60 x 400 mm	1800 mm	43 W	239,95 €
342202	black	3000/4000 K	3100/3200 lm	60 x 400 mm	1800 mm	43 W	239,95 €
342205	white	3000/4000 K	5500/5600 lm	60 x 600 mm	1800 mm	65 W	399,95 €
342207	silver brushed	3000/4000 K	5500/5600 lm	60 x 600 mm	1800 mm	65 W	399,95 €
342208	coffee brushed	3000/4000 K	5500/5600 lm	60 x 600 mm	1800 mm	65 W	399,95 €
342206	black	3000/4000 K	5500/5600 lm	60 x 600 mm	1800 mm	65 W	399,95 €
342209	white	3000/4000 K	7600/7800 lm	60 x 800 mm	3000 mm	95 W	559,95 €
342211	silver brushed	3000/4000 K	7600/7800 lm	60 x 800 mm	3000 mm	95 W	559,95 €
342212	coffee brushed	3000/4000 K	7600/7800 lm	60 x 800 mm	3000 mm	95 W	559,95 €
342210	black	3000/4000 K	7600/7800 lm	60 x 800 mm	3000 mm	95 W	559,95 €

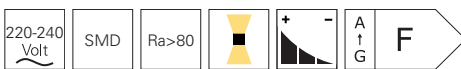

accessories

930709	diffusion disc 400 mm UGR<19	14,95 €
930710	diffusion disc 600 mm UGR<19	24,95 €
930711	diffusion disc 800 mm UGR<19	39,95 €





MEROPE

The pendant lights of the MEROPE Series unite timeless elegance and reduced modernity. Available diameters are 400, 600 and 800mm and the light colour [3000K/4000K] can be chosen with a switch before mounting. The outer ring is finished in white, silver, coffee brown or black.



MEROPE 400 + 600

- timeless, minimalist design
- high light current
- aluminium
- socket H x Ø: 65 x 220 mm
- max. suspension: 1800 mm
- light colour adjustable via dip switch
- dimmable via phase control or phase cut-off



suitable
ceiling lights
page 61
348186-348193

item	colour	colour temperature	light current	dimensions H x Ø	power	price
342189	<input type="checkbox"/> white	WW NW 3000/4000 K	2100/2200 lm	35 x 380 mm	30 W	209,95 €
342191	<input type="checkbox"/> silver brushed	WW NW 3000/4000 K	2100/2200 lm	35 x 380 mm	30 W	209,95 €
342192	<input type="checkbox"/> coffee brushed	WW NW 3000/4000 K	2100/2200 lm	35 x 380 mm	30 W	209,95 €
342190	<input type="checkbox"/> black	WW NW 3000/4000 K	2100/2200 lm	35 x 380 mm	30 W	209,95 €
342193	<input type="checkbox"/> white	WW NW 3000/4000 K	3100/3200 lm	35 x 580 mm	42 W	279,95 €
342195	<input type="checkbox"/> silver brushed	WW NW 3000/4000 K	3100/3200 lm	35 x 580 mm	42 W	279,95 €
342196	<input type="checkbox"/> coffee brushed	WW NW 3000/4000 K	3100/3200 lm	35 x 580 mm	42 W	279,95 €
342194	<input type="checkbox"/> black	WW NW 3000/4000 K	3100/3200 lm	35 x 580 mm	42 W	279,95 €

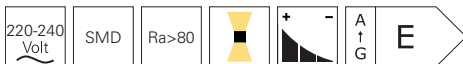

MEROPE 800

- timeless, minimalist design
- high light current
- aluminium
- socket H x Ø: 65 x 275 mm
- max. suspension: 3000 mm
- light colour adjustable via dip switch
- dimmable via phase control or phase cut-off



suitable
ceiling lights
page 61
348194-348197

item	colour	colour temperature	light current	dimensions H x Ø	power	price
342197	<input type="checkbox"/> white	WW NW 3000/4000 K	4800/4900 lm	35 x 780 mm	60 W	469,95 €
342199	<input type="checkbox"/> silver brushed	WW NW 3000/4000 K	4800/4900 lm	35 x 780 mm	60 W	469,95 €
342200	<input type="checkbox"/> coffee brushed	WW NW 3000/4000 K	4800/4900 lm	35 x 780 mm	60 W	469,95 €
342198	<input type="checkbox"/> black	WW NW 3000/4000 K	4800/4900 lm	35 x 780 mm	60 W	469,95 €







SCULPTORIS 400 + 600

- timeless, minimalist design
- high light current
- aluminium
- socket H x Ø: 65 x 220 mm
- max. suspension: 1800 mm
- light colour adjustable via dip switch
- dimmable via phase control or phase cut-off



suitable
ceiling lights
page 63
348180-348183

item	colour	colour temperature	light current	dimensions H x Ø	power	price
342183	<input type="checkbox"/> white	<input type="checkbox"/> WW <input type="checkbox"/> NW 3000/4000 K	1900/2000 lm	85 x 400 mm	30 W	289,95 €
342184	<input checked="" type="checkbox"/> black	<input type="checkbox"/> WW <input type="checkbox"/> NW 3000/4000 K	1900/2000 lm	85 x 400 mm	30 W	289,95 €
342185	<input type="checkbox"/> white	<input type="checkbox"/> WW <input type="checkbox"/> NW 3000/4000 K	3000/3100 lm	110 x 600 mm	42 W	369,95 €
342186	<input checked="" type="checkbox"/> black	<input type="checkbox"/> WW <input type="checkbox"/> NW 3000/4000 K	3000/3100 lm	110 x 600 mm	42 W	369,95 €

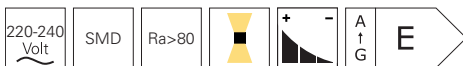

SCULPTORIS 800

- timeless, minimalist design
- high light current
- aluminium
- socket H x Ø: 65 x 275 mm
- max. suspension: 3000 mm
- light colour adjustable via dip switch
- dimmable via phase control or phase cut-off



suitable
ceiling lights
page 63
348184
348185

item	colour	colour temperature	light current	dimensions H x Ø	power	price
342187	<input type="checkbox"/> white	<input type="checkbox"/> WW <input type="checkbox"/> NW 3000/4000 K	4000/4100 lm	110 x 800 mm	60 W	569,95 €
342188	<input checked="" type="checkbox"/> black	<input type="checkbox"/> WW <input type="checkbox"/> NW 3000/4000 K	4000/4100 lm	110 x 800 mm	60 W	569,95 €





APOLLON

The slim and purist pendant lamp APOLLON fits seamlessly into almost any ambience and provides a rich warm white light in addition to the noble look. The APOLLON is available in two different sizes with a matte surface in black and white.



view from above



view from below

APOLLON

- slim, noble design
- incl. uplight for indirect light
- aluminium
- socket L x B x H: 650/850 x 35 x 48 mm
- max. suspension: 3000 mm
- dimmable via phase control or phase cut-off

item	colour	colour temperature	light current	dimensions L x B x H	power	EEL	price
342149	white	2700 K	1755 lm	1004 x 80 x 8 mm	28 W	G	319,95 €
342148	black	2700 K	1755 lm	1004 x 80 x 8 mm	28 W	G	319,95 €
342151	white	2700 K	2475 lm	1464 x 80 x 8 mm	42 W	F	429,95 €
342150	black	2700 K	2475 lm	1464 x 80 x 8 mm	42 W	F	429,95 €



MADERA

The MADERA pendant luminaire combines modern design with environmental-friendly manufacturing. Each luminaire is made of high-quality European oak wood with FSC certification, sourced from sustainable forestry. With its touch sensor on the side, you can dim the brightness of the lamp to your liking and thus create a pleasant atmosphere. Choose between versions with indirect upward lighting for a soft ambience or select the practical height-adjustable option with a cable pull to adjust the luminaire perfectly at any time. To help protect our environment, the MADERA pendant luminaires are packaged environmentally friendly.



height adjustable



uplight and touch sensor



suitable ceiling lights
page 91
348147



suitable wall light
page 184
341248

MADERA

- modern design, exclusively at DEKO-LIGHT
- manufactured in Europe from high-quality, oiled oak wood of grade A
- FSC-certified raw material oak wood from sustainable forests
- environmental friendly packaging
- continuously dimmable via touch sensor
- height adjustable via cable pull
- incl. uplight [only 342235, 342236]
- oak wood | iron
- socket L x W x H: 370 x 50 x 30 mm
- max. suspension: 1000 mm



suitable table / floor lights
page 206
346044
343031

item	colour	colour temperature	light current	dimensions L x W x H	power	price
342234	brown, black	3000 K	1600 lm	900 x 42 x 60 mm	13 W	549,95 €
342235	brown, black	3000 K	2890 lm	1200 x 42 x 60 mm	22 W	699,95 €
342236	brown, black	3000 K	4400 lm	1600 x 42 x 60 mm	33 W	799,95 €







page 57



page 59



page 61



page 63



page 64



page 67



page 67



page 69



page 70



page 70



page 71



page 72



page 72



page 73



page 75



page 76



page 77



page 78



page 78



page 79



page 80



page 80

surface mounted ceiling lights



□ □
page 81



□ ■ □
from page 83



□ ■ □
from page 87



■ □
page 91



ZANIAH

While most surface-mounted ceiling luminaires focus on flat surfaces and covers, the ZANIAH deliberately places its 360° light source [optionally available as 12W, 18W and 24W versions] in the foreground. This is not only for optical reasons, because the ZANIAH can be combined with the covers of the ORBIT series, which is also new. In this way, not only are different RAL colours available – the ZANIAH itself is also available in eight colour variants per power class.



ZANIAH 12W / 18W / 24W

- modern design
- interchangeable covers in eight colours
- aluminium
- dimmable via phase control or phase cut-off

item	colour	colour temperature	light current	H	Ø	power	EEL	price
620040	white	3000 K	1500 lm	42 mm	190 mm	12 W	F	99,95 €
620033	silver coloured	3000 K	1500 lm	42 mm	190 mm	12 W	F	99,95 €
620038	grey	3000 K	1500 lm	42 mm	190 mm	12 W	F	99,95 €
620039	black	3000 K	1500 lm	42 mm	190 mm	12 W	F	99,95 €
620036	red	3000 K	1500 lm	42 mm	190 mm	12 W	F	99,95 €
620037	yellow	3000 K	1500 lm	42 mm	190 mm	12 W	F	99,95 €
620034	blue	3000 K	1500 lm	42 mm	190 mm	12 W	F	99,95 €
620035	green	3000 K	1500 lm	42 mm	190 mm	12 W	F	99,95 €
620048	white	3000 K	2000 lm	46 mm	370 mm	18 W	G	109,95 €
620041	silver coloured	3000 K	2000 lm	46 mm	370 mm	18 W	G	109,95 €
620046	grey	3000 K	2000 lm	46 mm	370 mm	18 W	G	109,95 €
620047	black	3000 K	2000 lm	46 mm	370 mm	18 W	G	109,95 €
620044	red	3000 K	2000 lm	46 mm	370 mm	18 W	G	109,95 €
620045	yellow	3000 K	2000 lm	46 mm	370 mm	18 W	G	109,95 €
620042	blue	3000 K	2000 lm	46 mm	370 mm	18 W	G	109,95 €
620043	green	3000 K	2000 lm	46 mm	370 mm	18 W	G	109,95 €
620056	white	3000 K	2560 lm	46 mm	420 mm	24 W	F	119,95 €
620049	silver coloured	3000 K	2560 lm	46 mm	420 mm	24 W	F	119,95 €
620054	grey	3000 K	2560 lm	46 mm	420 mm	24 W	F	119,95 €
620055	black	3000 K	2560 lm	46 mm	420 mm	24 W	F	119,95 €
620052	red	3000 K	2560 lm	46 mm	420 mm	24 W	F	119,95 €
620053	yellow	3000 K	2560 lm	46 mm	420 mm	24 W	F	119,95 €
620050	blue	3000 K	2560 lm	46 mm	420 mm	24 W	F	119,95 €
620051	green	3000 K	2560 lm	46 mm	420 mm	24 W	F	119,95 €





MENKAR

The ceiling lamps of the MENKAR series can be combined great with the MEROPE series – as they come out of the same family. Just like the MEROPE, the MENKAR comes with a fine finished outer ring made of aluminum in white, silver, coffee brown or black colour.



MENKAR 400 + 600 + 800

- timeless design
- high light current [indirect light component ca. 15 - 20%]
- aluminium
- light colour adjustable via dip switch
- dimmable via phase control or phase cut-off

suitable
pendant lights
page 45
342201-342212

item	colour	colour temperature	light current	dimensions H x Ø	power	price
348198	white	3000/4000 K	3100/3200 lm	90 x 400 mm	43 W	219,95 €
348200	silver brushed	3000/4000 K	3100/3200 lm	90 x 400 mm	43 W	219,95 €
348201	coffee brushed	3000/4000 K	3100/3200 lm	90 x 400 mm	43 W	219,95 €
348199	black	3000/4000 K	3100/3200 lm	90 x 400 mm	43 W	219,95 €
348202	white	3000/4000 K	5500/5600 lm	90 x 600 mm	65 W	379,95 €
348204	silver brushed	3000/4000 K	5500/5600 lm	90 x 600 mm	65 W	379,95 €
348205	coffee brushed	3000/4000 K	5500/5600 lm	90 x 600 mm	65 W	379,95 €
348203	black	3000/4000 K	5500/5600 lm	90 x 600 mm	65 W	379,95 €
348206	white	3000/4000 K	7600/7800 lm	90 x 800 mm	95 W	539,95 €
348208	silver brushed	3000/4000 K	7600/7800 lm	90 x 800 mm	95 W	539,95 €
348209	coffee brushed	3000/4000 K	7600/7800 lm	90 x 800 mm	95 W	539,95 €
348207	black	3000/4000 K	7600/7800 lm	90 x 800 mm	95 W	539,95 €

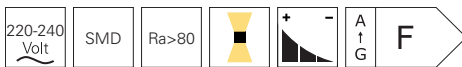

accessories

930709	diffusion disc 400 mm UGR<19	14,95 €
930710	diffusion disc 600 mm UGR<19	24,95 €
930711	diffusion disc 800 mm UGR<19	39,95 €





MEROPE

The absolutely timeless MEROPE satisfies not only with the high light current or the very small mounting dimension, but is also an eyecatcher with the elegant outer aluminum ring. You get the choice between sandblasted surface in white or black or brushed surface in silver or trending colour coffee brown finish. Because of the three different sizes 380, 580 or 780mm, the MEROPE fits even more flexible in different surroundings.



MEROPE 400 + 600 + 800

- timeless design
- high light current
- aluminium
- light colour adjustable via dip switch
- dimmable via phase control or phase cut-off

suitable
pendant lights
page 47
342189-342200

item	colour	colour temperature	light current	dimensions H x Ø	power	EEL	price
348186	white	3000/4000 K	2100/2200 lm	60 x 380 mm	30 W	E	189,95 €
348188	silver brushed	3000/4000 K	2100/2200 lm	60 x 380 mm	30 W	E	189,95 €
348189	coffee brushed	3000/4000 K	2100/2200 lm	60 x 380 mm	30 W	E	189,95 €
348187	black	3000/4000 K	2100/2200 lm	60 x 380 mm	30 W	E	189,95 €
348190	white	3000/4000 K	3100/3200 lm	60 x 580 mm	42 W	E	269,95 €
348192	silver brushed	3000/4000 K	3100/3200 lm	60 x 580 mm	42 W	E	269,95 €
348193	coffee brushed	3000/4000 K	3100/3200 lm	60 x 580 mm	42 W	E	269,95 €
348191	black	3000/4000 K	3100/3200 lm	60 x 580 mm	42 W	E	269,95 €
348194	white	3000/4000 K	4800/4900 lm	60 x 780 mm	60 W		449,95 €
348196	silver brushed	3000/4000 K	4800/4900 lm	60 x 780 mm	60 W	F	449,95 €
348197	coffee brushed	3000/4000 K	4800/4900 lm	60 x 780 mm	60 W	F	449,95 €
348195	black	3000/4000 K	4800/4900 lm	60 x 780 mm	60 W	F	449,95 €





Mit freundlicher Unterstützung von Regionaldirektion für Deutsche Vermögensberatung Pierre Werner / Direktion für Deutsche Vermögensberatung Uwe Liebholz

SCULPTORIS

Thanks to its different versions, the SCULPTORIS series can be optimally integrated both in the bedroom as a surface mounted ceiling luminaire and in the living or dining area as a pendant luminaire.



SCULPTORIS 400 + 600 + 800

- timeless, minimalist design
- high light current
- aluminium
- light colour adjustable via dip switch
- dimmable via phase control or phase cut-off



suitable
pendant
lights
page 49
342183-342188

item	colour	colour temperature	light current	dimensions H x Ø	power	EEL	price
348180	<input type="checkbox"/> white	<input type="checkbox"/> WW <input type="checkbox"/> NW 3000/4000 K	1900/2000 lm	100 x 400 mm	30 W	E	269,95 €
348181	<input checked="" type="checkbox"/> black	<input type="checkbox"/> WW <input type="checkbox"/> NW 3000/4000 K	1900/2000 lm	100 x 400 mm	30 W	E	269,95 €
348182	<input type="checkbox"/> white	<input type="checkbox"/> WW <input type="checkbox"/> NW 3000/4000 K	3000/3100 lm	130 x 600 mm	42 W	E	349,95 €
348183	<input checked="" type="checkbox"/> black	<input type="checkbox"/> WW <input type="checkbox"/> NW 3000/4000 K	3000/3100 lm	130 x 600 mm	42 W	E	349,95 €
348184	<input type="checkbox"/> white	<input type="checkbox"/> WW <input type="checkbox"/> NW 3000/4000 K	4000/4100 lm	130 x 800 mm	60 W	F	579,95 €
348185	<input checked="" type="checkbox"/> black	<input type="checkbox"/> WW <input type="checkbox"/> NW 3000/4000 K	4000/4100 lm	130 x 800 mm	60 W	F	579,95 €





HELEN I 3 COLOUR

- plastic
- dimensions H x Ø: 83 x 276 mm
- socket H x Ø: 20 x 251 mm
- light colour adjustable via dip switch

item	colour	colour temperature	light current	price
348051	□ silver coloured brushed	ww nw cw 3000/4000/5500 K	1400 lm	79,95 €

220-240 Volt	15 W	SMD	84 LED	Ra>80	115°	IP54	A t G	G
--------------	------	-----	--------	-------	------	------	-------	---



HELEN II 3 COLOUR

- plastic
- dimensions H x Ø: 89 x 351 mm
- socket H x Ø: 22 x 326 mm
- light colour adjustable via dip switch

item	colour	colour temperature	light current	price
348052	□ silver coloured brushed	ww nw cw 3000/4000/5500 K	1800 lm	119,95 €

220-240 Volt	19 W	SMD	120 LED	Ra>80	115°	IP54	A t G	G
--------------	------	-----	---------	-------	------	------	-------	---

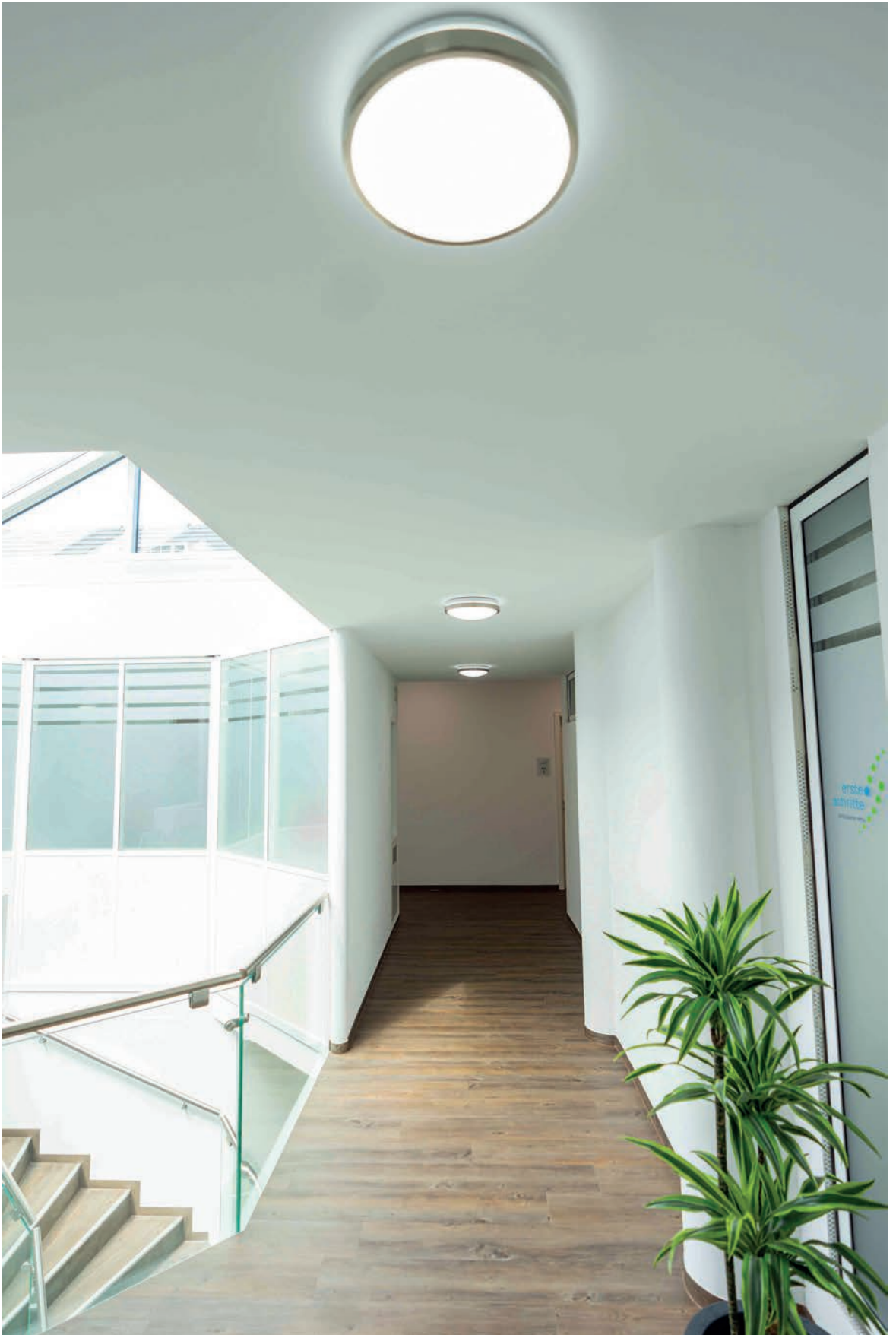



ALTAIS

It takes a lot to bring the ALTAIS series into embarrassment. Thanks to IP54 and impact resistance class IK10, the outdoor luminaires are convincing as slim all-rounders in both public and private areas. The ALTAIS luminaires offer additional flexibility thanks to their integrated motion sensor [programmable via the remote control supplied] and the adjustable light colour for different lighting scenarios.



product video





ALTAIS

- light colour adjustable via dip switch
- plastic

item	colour	colour temperature	light current	dimensions H x Ø	power	EEL	price
348141	<input type="checkbox"/> white	<input type="checkbox"/> WW <input type="checkbox"/> NW <input type="checkbox"/> CW 3000/4000/6000 K	1260 lm	48 x 220 mm	12W	E	69,95 €
348143	<input type="checkbox"/> white	<input type="checkbox"/> WW <input type="checkbox"/> NW <input type="checkbox"/> CW 3000/4000/6000 K	1870 lm	48 x 280 mm	18W	D	89,95 €
348145	<input type="checkbox"/> white	<input type="checkbox"/> WW <input type="checkbox"/> NW <input type="checkbox"/> CW 3000/4000/6000 K	2715 lm	48 x 330 mm	25W	D	109,95 €



ALTAIS MOTION

- light colour adjustable via dip switch
- detection area, daylight sensor and light duration can be individualised via remote control
- plastic
- incl. remote control
- incl. motion sensor

item	colour	colour temperature	light current	dimensions H x Ø	power	EEL	price
348142	<input type="checkbox"/> white	<input type="checkbox"/> WW <input type="checkbox"/> NW <input type="checkbox"/> CW 3000/4000/6000 K	1260 lm	48 x 220 mm	12W	E	105,95 €
348144	<input type="checkbox"/> white	<input type="checkbox"/> WW <input type="checkbox"/> NW <input type="checkbox"/> CW 3000/4000/6000 K	1870 lm	48 x 280 mm	18W	D	129,95 €
348146	<input type="checkbox"/> white	<input type="checkbox"/> WW <input type="checkbox"/> NW <input type="checkbox"/> CW 3000/4000/6000 K	2715 lm	48 x 330 mm	25W	D	149,95 €





SUBRA

Our new SUBRA lamps can be mounted on the wall just like the ceiling and convince with the slim silhouette. This is not only because of the small installation height of 7cm, but also the orbital light ring which is an additional design element. When it comes to dimming, the SUBRA is even more subtle. You got the choice between the analog TRIAC or the digital DALI version. And there is another version with an adjustable motion sensor.



product video



safe assembly thanks to safety rope

SUBRA

- classic design with illuminated stripe as highlight
- easy mounting by means of clip connection
- high light current
- IP54 ceiling mounting / IP20 wall mounting
- aluminium
- dimensions H x Ø: 70 x 350 mm
- socket H x Ø: 22 x 290 mm

item	colour	colour temperature	light current	power	control	price
401007	<input type="checkbox"/> white	3000 K	2600 lm	28,50 W	TRIAC	229,95 €
401008	<input type="checkbox"/> white	4000 K	2840 lm	28,50 W	TRIAC	229,95 €
401005	<input type="checkbox"/> white	3000 K	2603 lm	28,70 W	motion sensor	269,95 €
401006	<input type="checkbox"/> white	4000 K	2651 lm	28,70 W	motion sensor	269,95 €
401003	<input type="checkbox"/> white	3000 K	2636 lm	28,90 W	DALI	289,95 €
401004	<input type="checkbox"/> white	4000 K	2671 lm	28,90 W	DALI	289,95 €





INDI I

- aluminium
- luminaire H x Ø: 124 x 100 mm
- socket H x Ø: 25 x 80 mm
- dimmable via optional illuminants

item	colour	price
348085	 silver coloured brushed	29,95 €



suitable illuminants on page 800-801



INDI II

- aluminium
- luminaire H x Ø: 124 x 172 mm
- socket H x Ø: 25 x 135 mm
- dimmable via optional illuminants

item	colour	price
348086	 silver coloured brushed	59,95 €



suitable illuminants on page 800-801



INDI III

- aluminium
- luminaire H x Ø: 124 x 250 mm
- socket H x Ø: 25 x 190 mm
- dimmable via optional illuminants

item	colour	price
348087	<input type="checkbox"/> silver coloured brushed	89,95 €



suitable illuminants on page 800-801





suitable
recessed ceiling
lights
from page 138
565343
565361



suitable
wall-mounted
luminaires
page 171
341215
341232



suitable
power
luminaire
page 352
707044
707131

UNI II

- aluminium diecast
- luminaire H x Ø: 103 x 100 mm
- socket H x Ø: 14,5 x 96 mm
- dimmable via phase control or phase cut-off

item	colour	colour temperature	light current	price
348124	□ white	ww 3000 K	670 lm	144,95 €
348179	■ black	ww 3000 K	670 lm	144,95 €



suitable
recessed ceiling
lights
from page 138
565343
565361



suitable
wall-mounted
luminaires
page 171
3412158
341232



suitable
power
luminaire
page 352
707044
707131

UNI II DOUBLE

- aluminium diecast
- luminaire L x B x H: 212 x 100 x 103 mm
- socket L x B x H: 212 x 20 x 14 mm
- dimmable via phase control or phase cut-off

item	colour	colour temperature	light current	price
348125	□ white	ww 3000 K	1350 lm	259,95 €
348175	■ black	ww 3000 K	1350 lm	259,95 €





suitable recessed ceiling lights
from page 138
565343
565361



suitable wall-mounted luminaires
page 171
3412158
341232



suitable power luminaire
page 352
707044
707131

UNI II TRIPLE

- aluminium diecast
- luminaire L x B x H: 324 x 100 x 103 mm
- socket L x B x H: 315 x 25 x 14,5 mm
- dimmable via phase control or phase cut-off

item	colour	colour temperature	light current	price
348107	□ white	www 3000 K	2150 lm	369,95 €
348210	■ black	www 3000 K	2150 lm	369,95 €

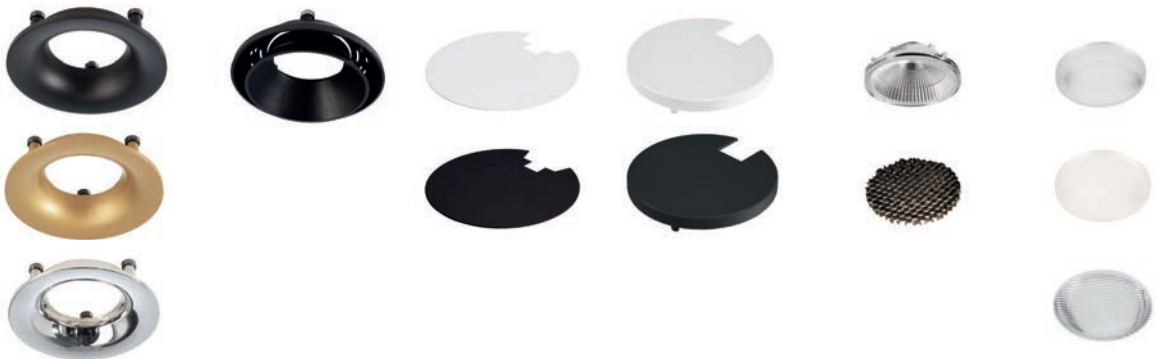

accessories für UNI II series

930339	reflector ring black	10,95 €
930340	reflector ring gold optics	10,95 €
930341	reflector ring chrome	10,95 €
930371	reflector ring II black glossy	10,95 €
930334	cover backside white	3,55 €
930335	cover backside black	2,95 €
930336	cover heatsink white	3,55 €
930337	cover heatsink black	7,95 €
930306	reflector 48°	8,95 €
930307	honeycomb filter	8,95 €
930308	spread lens 40° clear/satined	8,95 €
930309	softening lens 48° satined	8,95 €
930310	linear spread lens 40°/80° asymmetric clear/satined	8,95 €



UNI II

The UNI II series comprises high-quality surface-mounted luminaires for use on walls and ceilings in commercial and private rooms. The rotatable and swivelling luminaire heads are equipped with warm white COB LEDs and can be fitted flush onto the base if required to shine vertically downwards like a ceiling spotlight. In addition to the single, double and triple versions, both a mini version [with smaller luminaire head and base] and a MAX version are available, as well as a variant for use in tracks.



UNI II MINI

- high colour rendition
- rotatable and swivellable
- aluminium diecast
- luminaire L x Ø: 91 x 75 mm
- socket H x Ø: 44 x 75 mm
- dimmable via phase control or phase cut-off



suitable
recessed ceiling
lights
page 139
565342
565354

item	colour	colour temperature	light current	power	price
348233	□ white	www 2700 K	1000 lm	8,9 W	129,95 €
348234	■ black	www 2700 K	1000 lm	8,9 W	129,95 €
348122	□ white	www 3000 K	600 lm	8,0 W	119,95 €
348178	■ black	www 3000 K	600 lm	8,0 W	119,95 €



suitable
power
luminaire
page 299
707187
707188



accessories für UNI II MINI series

930330	reflector ring white	10,95 €
930331	reflector ring black	10,95 €
930332	reflector ring gold	10,95 €
930333	reflector ring chrome	10,95 €
930381	reflector ring II black	10,95 €
930326	cover backside white	3,55 €
930327	cover backside black	3,45 €
930328	cover heatsink white	3,55 €
930329	cover heatsink black	2,95 €
930770	reflector 24°	10,95 €
930771	reflector 48°	10,95 €



UNI II MINI DOUBLE

- high colour rendition
- rotatable and swivellable
- aluminium diecast
- luminaire L x B x H: 160 x 75 x 91 mm
- socket L x B x H: 160 x 75 x 44 mm
- dimmable via phase control or phase cut-off
- adaptateur secteur inclus



suitable
recessed ceiling
lights
page 139
565342
565354

item	colour	colour temperature	light current	power	price
348235	<input type="checkbox"/> white	2700 K	2000 lm	2x 8,9 W	209,95 €
348236	<input checked="" type="checkbox"/> black	2700 K	2000 lm	2x 8,9 W	209,95 €
348123	<input type="checkbox"/> white	3000 K	980 lm	15,0 W	199,95 €
348177	<input checked="" type="checkbox"/> black	3000 K	980 lm	15,0 W	199,95 €



suitable
power
luminaire
page 299
707187
707188



accessories für UNI II MINI series

930330	reflector ring white	10,95 €
930331	reflector ring black	10,95 €
930332	reflector ring gold	10,95 €
930333	reflector ring chrome	10,95 €
930381	reflector ring II black	10,95 €
930326	cover backside white	3,55 €
930327	cover backside black	3,45 €
930328	cover heatsink white	3,55 €
930329	cover heatsink black	2,95 €
930770	reflector 24°	10,95 €
930771	reflector 48°	10,95 €



UNI II MAX

- aluminium diecast
- luminaire H x Ø: 128 x 125 mm
- socket H x Ø: 62 x 125 mm
- dimmable via phase control or phase cut-off

item	colour	colour temperature	light current	price
348127	white	3000 K	2410 lm	249,95 €
348176	black	3000 K	2410 lm	249,95 €



suitable
recessed ceiling
lights
page 139
565344
565351



accessories für UNI II MAX

930397	reflector ring white	12,95 €
930398	reflector ring black	10,95 €
930399	reflector ring gold	14,95 €
930382	reflector ring II black glossy	10,95 €
930393	cover backside white	10,95 €
930394	cover backside black	10,95 €
930395	cover heatsink white	10,95 €
930396	cover heatsink black	10,95 €
930390	reflector 24°	10,95 €
930391	reflector 36°	12,95 €
930392	reflector 48°	10,95 €



BENGALA

- aluminium
- luminaire H x Ø: 120 x 96 mm
- socket Ø: 96 mm
- dimmable via optional illuminants

item	colour	price
348023	<input type="checkbox"/> white	44,95 €
122416	<input type="checkbox"/> silver coloured brushed	44,95 €
348022	<input type="checkbox"/> black	44,95 €



suitable illuminants on page 800-801



DATO

- aluminium
- luminaire L x B x H: 96 x 96 x 120 mm
- socket L x B: 96 x 96 mm
- dimmable via optional illuminants

item	colour	price
348025	<input type="checkbox"/> white	44,95 €
122417	<input type="checkbox"/> silver coloured brushed	44,95 €
348024	<input type="checkbox"/> black	44,95 €



suitable illuminants on page 800-801



MONA

- aluminium diecast
- dimmable via optional illuminants

item	colour	dimensions L x B x H	power	price
348001	□ white	93 x 93 x 120 mm	1x max.50 W	59,95 €
348002	■ black	93 x 93 x 120 mm	1x max.50 W	59,95 €
348004	□ white	186 x 93 x 120 mm	2x max.50 W	109,95 €
348005	■ black	186 x 93 x 120 mm	2x max.50 W	109,95 €



suitable illuminants on page 800-801





SKY LED

- aluminium
- dimensions L x B x H: 105 x 105 x 105 mm
- dimmable via phase cut-off

item	colour	colour temperature	light current	price
348013	<input type="checkbox"/> white	3000 K	770 lm	129,95 €

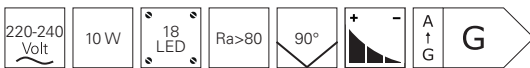

NAOS

- concrete
- socket L x B x H: 60 x 40 x 45 mm
- dimmable via optional illuminants

item	colour	dimensions L x B x H / H x Ø	price
348048	<input checked="" type="checkbox"/> grey	70 x 70 x 112 mm	69,95 €
348049	<input checked="" type="checkbox"/> grey	112 x 70 mm	69,95 €



suitable illuminants on page 800-801

DRACONIS

The DRACONIS series from DEKO-LIGHT enables the flexible ceiling lighting for a wide range of applications in the industrial, commercial and logistics sectors. The DRACONIS luminaire is for the optional use as a surface-mounted ceiling luminaire or in a 3-phase track system. The power [45, 55 or 72 W] and light colour [2,700, 3,500 or 4,000 K] can be adjusted via a switch on the back of the housing. In order to integrate the DRACONIS in almost any environment, we offer several lenses for asymmetrical or symmetrical illumination in different beam angles. The maximum light current is 8,215 lumens.



DRACONIS

- light colour and output adjustable via dip switch
- high light current [bis 8200 lm]
- aluminium diecast
- dimensions L x B x H: 578 x 189 x 71 mm
- socket L x B x H: 102 x 88 x 25 mm
- luminous flux at 2700 K:
72 W = 7330 lm / 55 W = 6000 lm / 45 W = 5030 lm
- luminous flux at 3000 K:
72 W = 8210 lm / 55 W = 6590 lm / 45 W = 5560 lm
- luminous flux at 4000 K:
72 W = 8250 lm / 55 W = 6950 lm / 45 W = 5700 lm



suitable
power
luminaires
page 332
620120
620119

item	colour	colour temperature	price
348128	<input type="checkbox"/> white	<input type="checkbox"/> WW <input type="checkbox"/> NW 2700 / 3500 / 4000 K	269,95 €
348099	<input type="checkbox"/> aluminium	<input type="checkbox"/> WW <input type="checkbox"/> NW 2700 / 3500 / 4000 K	269,95 €



accessories

930577	15° lens asymmetric	9,95 €
930544	20° lens symmetric	9,95 €
930545	30° lens symmetric	9,95 €
930546	90° lens symmetric	9,95 €





LUCEA

The ceiling luminaires of the LUCEA series are available in the versions 6, 10, 15, 20 and 30 watts. They offer up to 2,900 lumens of light output, depending on the version. Through lenses, which are available as an option, the beam angle can be narrowed or widened.





suitable
pendant lights
page 26
342177
342178

LUCEA 6 + 10

- high colour rendering
- light colour adjustable in two steps
[only 348153 and 348154]
- dimmable
- aluminium diecast
- dimensions H x Ø: 157 x 65 mm
- dimmable via phase control or phase cut-off
- light colour adjustable via dip switch
- incl. black reflector ring



suitable
power
luminaires
1 phase
from page 294
707165-707168
707175-707178

item	colour	colour temperature	light current	power	price
348213	<input type="checkbox"/> white	2700 K	600 lm	6 W	129,95 € NEW
348214	<input checked="" type="checkbox"/> black	2700 K	600 lm	6 W	129,95 € NEW
348215	<input type="checkbox"/> white	2700 K	1000 lm	10 W	119,95 € NEW
348216	<input checked="" type="checkbox"/> black	2700 K	1000 lm	10 W	119,95 € NEW
348153	<input type="checkbox"/> white	3000 / 4000 K	930 / 1000 lm	10 W	119,95 €
348154	<input checked="" type="checkbox"/> black	3000 / 4000 K	930 / 1000 lm	10 W	119,95 €



suitable
power
luminaires
3 phases
from page 344
707116
707117
707124
707125



accessories

930679	lens 24°	9,95 €
930756	Reflector ring white	4,95 €
930757	Reflector ring black	4,95 €
930758	Reflector ring gold	4,95 €

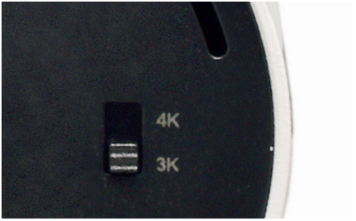

LUCEA 15 + 20

- high colour rendering
- light colour adjustable in two steps [only 348155 to 348158]
- dimmable
- aluminium diecast
- dimensions H x Ø: 178 x 85 mm
- dimmable via phase control or phase cut-off
- incl. black reflector ring



suitable
pendant lights
page 27
342179-342182



suitable
power
luminaires
from page 345
707118-707121
707126-707129

item	colour	colour temperature	light current	power	price
348155	<input type="checkbox"/> white	3000 / 4000 K	1460 / 1500 lm	15 W	139,95 €
348156	<input checked="" type="checkbox"/> black	3000 / 4000 K	1460 / 1500 lm	15 W	139,95 €
348157	<input type="checkbox"/> white	3000 / 4000 K	1930 / 2000 lm	20 W	159,95 €
348158	<input checked="" type="checkbox"/> black	3000 / 4000 K	1930 / 2000 lm	20 W	159,95 €



accessories

930680	lens 24°	12,95 €
930681	lens 60°	12,95 €
930759	Reflector ring white	5,95 €
930760	Reflector ring black	5,95 €
930761	Reflector ring gold	5,95 €



LUCEA 30

- high colour rendering
- light colour adjustable in two steps [only 348159 and 348160]
- dimmable
- aluminium diecast
- dimensions H x Ø: 211 x 100 mm
- dimmable via phase control or phase cut-off
- incl. black reflector ring



suitable
power
luminaires
page 346
707122
707123

item	colour	colour temperature	light current	price
348159	□ white	ww nw 3000 / 4000 K	2700 / 2900 lm	179,95 €
348160	■ black	ww nw 3000 / 4000 K	2700 / 2900 lm	179,95 €

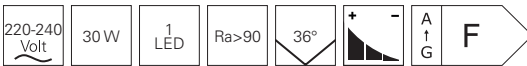

accessories

930682	lens 24°	15,95 €
930684	lens 60°	15,95 €
930762	Reflector ring white	6,95 €
930763	Reflector ring black	6,95 €
930764	Reflector ring gold	6,95 €



LUCEA

The rotating and swivelling ceiling luminaires of the LUCEA series are available in wattages of 6, 10, 15, 20 and 30 watts. With a rotation angle of 350° and a swivel angle of 90°, the luminaires can be individually adjusted to customer requirements. Depending on the version, they offer up to 2,900 lumens of light output. The beam angle can be narrowed or widened by exchanging optionally available lenses.





suitable
pendant lights
page 26
342177
342178

LUCEA TILT 6 + 10

- high colour rendering
- light colour adjustable in two steps
[only 348161 and 348162]
- dimmable
- aluminium diecast
- dimensions H x Ø: 218 x 65 mm
- socket H x Ø: 29 x 104,5 mm
- dimmable via phase control or phase cut-off
- incl. black reflector ring



suitable
power
luminaires
1 phase
from page 294
707165-707168
707175-707178

item	colour	colour temperature	light current	power	price
348223	<input type="checkbox"/> white	2700 K	600 lm	6 W	129,95 € NEW
348224	<input checked="" type="checkbox"/> black	2700 K	600 lm	6 W	129,95 € NEW
348225	<input type="checkbox"/> white	2700 K	1000 lm	10 W	119,95 € NEW
348226	<input checked="" type="checkbox"/> black	2700 K	1000 lm	10 W	119,95 € NEW
348161	<input type="checkbox"/> white	3000 / 4000 K	930 / 1000 lm	10 W	129,95 €
348162	<input checked="" type="checkbox"/> black	3000 / 4000 K	930 / 1000 lm	10 W	129,95 €



suitable
power
luminaires
3 phases
from page 344
707116
707117
707124
707125



accessories

930679	lens 24° for LUCEA 6/10	9,95 €
930752	barn door for LUCEA 6/10 white	22,95 €
930753	barn door for LUCEA 6/10 black	22,95 €
930756	reflector ring for LUCEA 6/10 white	4,95 €
930757	reflector ring for LUCEA 6/10 black	4,95 €
930758	reflector ring for LUCEA 6/10 gold	4,95 €

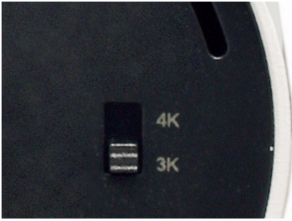

suitable
pendant lights
page 27
342179-342182



suitable
power
luminaires
from page 345
707118-707121
707126-707129

LUCEA TILT 15 + 20

- high colour rendering
- light colour adjustable in two steps
- dimmable
- aluminium diecast
- dimensions H x Ø: 241 x 85 mm
- socket H x Ø: 29 x 104,5 mm
- dimmable via phase control or phase cut-off
- incl. black reflector ring

item	colour	colour temperature	light current	power	price
348163	□ white	WW NW 3000 / 4000 K	1460 / 1500 lm	15 W	149,95 €
348164	■ black	WW NW 3000 / 4000 K	1460 / 1500 lm	15 W	149,95 €
348165	□ white	WW NW 3000 / 4000 K	1930 / 2000 lm	20 W	169,95 €
348166	■ black	WW NW 3000 / 4000 K	1930 / 2000 lm	20 W	169,95 €



accessories

930680	lens 24° for LUCEA 15/20	12,95 €
930681	lens 60° for LUCEA 15/20	12,95 €
930754	barn door for LUCEA 15/20 white	23,95 €
930755	barn door for LUCEA 15/20 black	23,95 €
930759	reflector ring for LUCEA 15/20 white	5,95 €
930760	reflector ring for LUCEA 15/20 black	5,95 €
930761	reflector ring for LUCEA 15/20 gold	5,95 €



LUCEA TILT 30

- high colour rendering
- light colour adjustable in two steps
- dimmable
- aluminium diecast
- dimensions H x Ø: 274 x 100 mm
- socket H x Ø: 29 x 104,5 mm
- dimmable via phase control or phase cut-off
- incl. black reflector ring



suitable
power
luminaires
page 346
707122
707123

item	colour	colour temperature	light current	price
348167	□ white	ww nw 3000 / 4000 K	2700 / 2900 lm	189,95 €
348168	■ black	ww nw 3000 / 4000 K	2700 / 2900 lm	189,95 €



accessories

930682	lens 24° for LUCEA 30/40	15,95 €
930684	lens 60° for LUCEA 30/40	15,95 €
930677	barn door for LUCEA 30/40 white	24,95 €
930678	barn door for LUCEA 30/40 black	24,95 €
930762	reflector ring for LUCEA 30/40 white	6,95 €
930763	reflector ring for LUCEA 30/40 black	6,95 €
930764	reflector ring for LUCEA 30/40 gold	6,95 €



MADERA

The MADERA series is made of first-class European oak wood and impresses with its modern design and mix of materials in private living areas, hotels, restaurants and many more. The noble MADERA luminaires distribute their powerful warm white light in any room and thus also cut an excellent figure as functional and high-quality lighting at reception counters and more.





uplight



suitable
pendant lights
page 52
342234
342235
342236



suitable
wall light
page 184
341248



suitable
table /
floor lights
page 206
346044
343031

MADERA

- modern design
- Made in Europe from high-quality grade A oak wood
- FSC-certified raw material oak wood from sustainable forests
- environmental friendly packaging
- incl. uplight [only 348212]
- oak wood | iron
- socket L x B x H: 250 x 135 x 30 mm

item	colour	colour temperature	light current	dimensions L x W x H	power	control	EEI	price
348147		3000 K	1120 lm	810 x 135 x 115 mm	15 W		F	489,95 €
348212		3000 K	2740 lm	1100 x 42 x 60 mm	22 W	dimmmable	D	549,95 €

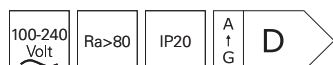



□ □ □
□ □ ■
page 96



□ □ □
□ □ ■
page 96



□ □ □
page 97



□
page 97



□ □ □
page 98



□ □
page 99



□ □
page 99



□ □ □
page 100



□
page 101



□
page 101



□
page 101



□
page 102



□ □
page 103



□ □
page 103



□
page 104



□
page 104



□ ■
page 105



□
page 105



□
page 106



□
page 106



□
page 106



□
page 107



□ □ □
page 107



□ □ □
page 108

built in ceiling lights



□ □ ■ □
from page 111



□ □
from page 114



□ □ □
page 116



□ □
page 117



□ □
from page 118



□ □ □
page 120



□ □
page 120



□ □
page 121



□
page 121



□
page 123



□ □
page 123





□ □ ■
□ □ □
page 127



□ □ ■
□ □ □
page 129



□ □
page 130



□ □ □
page 131



□ □
page 131



□ ■ □
page 132



□ □
from page 134



□ □
page 136



□ □ □
from page 137



□ ■ □
from page 138



□ ■ □
from page 140



□ □
from page 142



■ □
from page 144



□ □
from page 146



CEILING BUILT-IN RING

- metal
- dimensions H x Ø: 34 x89 mm
- dimmable via optional illuminants
- swivelling

item	colour	price
686868	<input type="checkbox"/> white	9,45 €
686869	<input type="checkbox"/> silver coloured chrome	9,45 €
686871	<input type="checkbox"/> silver coloured brushed	9,45 €
686880	<input type="checkbox"/> aluminium	9,45 €
686867	<input type="checkbox"/> copper coloured	9,45 €
686864	<input type="checkbox"/> black	9,45 €



accessories

829063	safety spacer	5,95 €
---------------	---------------	---------------

suitable illuminants on page 799



CEILING BUILT-IN RING GU10

- metal
- dimensions Ø: 89 mm
- dimmable via optional illuminants
- swivelling

item	colour	price
110032	<input type="checkbox"/> white	15,95 €
110033	<input type="checkbox"/> silver coloured chrome	15,95 €
110034	<input type="checkbox"/> silver coloured brushed	15,95 €
110035	<input type="checkbox"/> aluminium	15,95 €
110036	<input type="checkbox"/> copper coloured	15,95 €
110037	<input type="checkbox"/> black	15,95 €

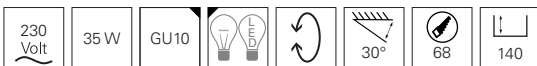

accessories

829063	safety spacer	5,95 €
---------------	---------------	---------------

suitable illuminants on page 800-801



CEILING BUILT-IN RING

- aluminium diecast
- dimensions H x Ø: 27 x 81 mm
- dimmable via optional illuminants
- swivelling



item	colour	price
449200	<input type="checkbox"/> white	12,95 €
449201	<input type="checkbox"/> silver coloured chrome	12,95 €
449202	<input type="checkbox"/> silver coloured brushed	12,95 €



accessories

829063 safety spacer **5,95 €**

suitable illuminants on page 799



CEILING BUILT-IN RING

- aluminium
- dimensions H x Ø: 26 x 92 mm
- dimmable via optional illuminants
- swivelling

item	colour	price
110222	<input type="checkbox"/> silver coloured	17,95 €



accessories

829063 safety spacer **5,95 €**

suitable illuminants on page 799

CEILING BUILT-IN RING

- aluminium diecast
- dimensions L x B x H: 82 x 82 x 27 mm
- dimmable via optional illuminants
- swivelling



item	colour	price
449210	<input type="checkbox"/> white	12,95 €
449211	<input type="checkbox"/> silver coloured chrome	12,95 €
449212	<input type="checkbox"/> silver coloured brushed	12,95 €

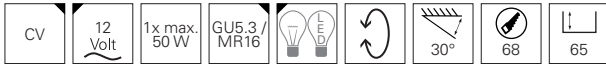

accessories

829063	safety spacer	5,95 €
---------------	---------------	---------------

suitable illuminants on page 799



With the kind support of Göbel's Schlosshotel / 36289 Friedewald

ALIOTH ROUND

- aluminium diecast
- dimensions H x Ø: 25 x 85 mm
- dimmable via optional illuminants
- swivelling



item	colour	price
110027	<input type="checkbox"/> white	15,95 €
110028	<input type="checkbox"/> silver coloured	15,95 €



accessories

829063 safety spacer **5,95 €**

suitable illuminants on page 799

ALIOTH ANGULAR

- aluminium diecast
- dimensions L x B : 90 x 90 mm
- dimmable via optional illuminants
- swivelling



item	colour	price
110029	<input type="checkbox"/> white	15,95 €
110030	<input type="checkbox"/> silver coloured	15,95 €



accessories

829063 safety spacer **5,95 €**

suitable illuminants on page 799



CEILING BUILT-IN RING

- aluminium diecast
- dimensions H x Ø: 42 x 84 mm
- dimmable via optional illuminants

item	colour	price
110000	<input type="checkbox"/> white	17,95 €
110001	<input type="checkbox"/> silver coloured	17,95 €
110002	<input type="checkbox"/> silver coloured chrome	17,95 €



accessories

829063 safety spacer **5,95 €**

suitable illuminants on page 799



ALGOL I

- aluminium diecast
- dimensions L x B x H: 100 x 100 x 40 mm
- dimmable via optional illuminants
- rotatable and swivellable



item	colour	price
110003	<input type="checkbox"/> white	17,95 €



accessories

829063	safety spacer	5,95 €
---------------	---------------	---------------

suitable illuminants on page 799

ALGOL II

- aluminium diecast
- dimensions L x B x H: 185 x 100 x 40 mm
- dimmable via optional illuminants
- rotatable and swivellable



item	colour	price
110004	<input type="checkbox"/> white	29,95 €



accessories

829063	safety spacer	5,95 €
---------------	---------------	---------------

suitable illuminants on page 799

ENIF

- aluminium diecast
- dimensions H x Ø: 40 x 100 mm
- dimmable via optional illuminants
- rotatable and swivellable



item	colour	price
110007	<input type="checkbox"/> white	17,95 €



accessories

829063	safety spacer	5,95 €
---------------	---------------	---------------

suitable illuminants on page 799



MIZAR I

- aluminium diecast
- dimensions H x Ø: 41 x 85 mm
- dimmable via optional illuminants



item	colour	price
110010	<input type="checkbox"/> white	17,95 €



accessories

829063	safety spacer	5,95 €
---------------	---------------	---------------

suitable illuminants on page 799



With the kind support of Albiterna Waldbrunn / Ziegler Technics buero@ziegler-technics.de



ALTAIR

- aluminium diecast
- dimensions H x Ø: 35 x 85 mm
- dimmable via optional illuminants

item	colour		price
110017	<input type="checkbox"/> white	round	11,95 €
110018	<input type="checkbox"/> white	angular	11,95 €



accessories

829063 safety spacer **5,95 €**

suitable illuminants on page 799



ARKTUR

- aluminium diecast
- dimensions H x Ø: 43 x 93 mm
- dimmable via optional illuminants
- swivelling

item	colour		price
110019	<input type="checkbox"/> white	round	15,95 €
110020	<input type="checkbox"/> white	angular	15,95 €



accessories

829063 safety spacer **5,95 €**

suitable illuminants on page 799



KARDAN I

- aluminium
- dimensions L x B x H: 98 x 98 x 90 mm
- dimmable via optional illuminants
- cardanic swivelling

item	colour	price
110100	□ silver coloured brushed	29,95 €



accessories

829063	safety spacer	5,95 €
---------------	---------------	---------------

suitable illuminants on page 799



KARDAN II

- aluminium
- dimensions L x B x H: 178 x 98 x 90 mm
- dimmable via optional illuminants
- cardanic swivelling

item	colour	price
110101	□ silver coloured brushed	49,95 €



accessories



829063	safety spacer	5,95 €
---------------	---------------	---------------

suitable illuminants on page 799



CEILING BUILT-IN RING

- aluminium
- dimensions L x B x H: 92 x 92 x 26 mm
- dimmable via optional illuminants
- rotatable and swivelling

item	colour	price
110421	 silver coloured brushed	19,95 €
110427	 black	19,95 €



accessories

829063	safety spacer	5,95 €
---------------	---------------	---------------

suitable illuminants on page 799



CEILING BUILT-IN RING

- aluminium
- dimensions L x B x H: 175 x 92 x 26 mm
- dimmable via optional illuminants
- rotatable and swivelling

item	colour	price
111821	 silver coloured brushed	35,95 €

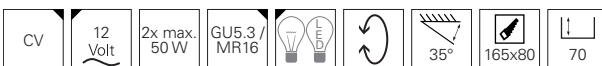

accessories

829063	safety spacer	5,95 €
---------------	---------------	---------------

suitable illuminants on page 799

CEILING BUILT-IN RING

- gypsum paintable
- dimensions H x Ø: 46 x 130 mm
- dimmable via optional illuminants

item	colour	price
110501	<input type="checkbox"/> white	24,95 €



accessories

829063 safety spacer **5,95 €**

suitable illuminants on page 799



CEILING BUILT-IN RING

- gypsum paintable
- dimensions L x B x H: 120 x 120 x 55 mm
- dimmable via optional illuminants

item	colour	price
110500	<input type="checkbox"/> white	24,95 €



accessories

829063 safety spacer **5,95 €**

suitable illuminants on page 799



CEILING BUILT-IN RING

- gypsum paintable
- dimensions H x Ø: 60 x 155 mm
- dimmable via optional illuminants

item	colour	price
110503	<input type="checkbox"/> white	42,95 €



accessories

829063 safety spacer **5,95 €**

suitable illuminants on page 799





CEILING BUILT-IN RING

- stainless steel
- dimensions H x Ø: 35 x 85 mm
- dimmable via optional illuminants

item	colour	price
122420	<input type="checkbox"/> silver coloured brushed	17,95 €



suitable illuminants on page 799



CEILING BUILT-IN RING

- aluminium diecast
- dimensions H x Ø: 43 x 102 mm
- dimmable via optional illuminants
- swivelling

item	colour	price
126070	<input type="checkbox"/> white	17,95 €
126074	<input type="checkbox"/> aluminium	17,95 €
126073	<input type="checkbox"/> silver coloured brushed	17,95 €



accessories

829063	safety spacer	5,95 €
---------------	---------------	---------------

suitable illuminants on page 799



COB 95

- aluminium
- dimensions H x Ø: 46 x 108 mm
- dimmable via phase control or phase cut-off
- swivelling

item	colour	colour temperature	light current	price
565067	<input type="checkbox"/> white	3000 K	820 lm	99,95 €
565070	<input type="checkbox"/> silver coloured brushed	3000 K	820 lm	99,95 €
565068	<input type="checkbox"/> white	4000 K	860 lm	99,95 €
565071	<input type="checkbox"/> silver coloured brushed	4000 K	860 lm	99,95 €



accessories

829063	safety spacer	5,95 €
180512	power supply 350 mA 0,7-18,0 W	23,95 €
862203	power supply dimmable 350 mA 6,3-12,0 W	36,95 €





Foto: Daniel Wieser - Architektur fotografie, Karlsruhe

ACRUX

All luminaires in the ACRUX series have a special feature; the light temperature [3000, 4000, 6000 K] can be set before installation with the switch on the back. This allows a lot of flexibility in the planning phase. The luminous intensity can be individually regulated by phase angle control. The cover supplied can be easily removed if necessary so that the luminaire can also be installed in its housing colour [white]. The integrated diffuser reduces glare and creates a pleasant lighting situation.



switch for setting the light temperature



3000 K



4000 K



6000 K



565315
incl. cover silver coloured



565362
incl. cover black

ACRUX 68

- plastic
- dimensions H x Ø: 57,5 x 95,0 mm
- white basic housing can also be used without coloured cover ring
- incl. optional monterbarer cover [silver coloured or black]
- dimmable via phase control or phase cut-off
- light colour adjustable via dip switch



item	colour	colour temperature	light current	price
565315	<input type="checkbox"/> <input type="checkbox"/> white/silver coloured	<input type="checkbox"/> <input type="checkbox"/> <input type="checkbox"/> 3000/4000/6000 K	630 lm	24,95 €
565362	<input type="checkbox"/> <input type="checkbox"/> white/black	<input type="checkbox"/> <input type="checkbox"/> <input type="checkbox"/> 3000/4000/6000 K	630 lm	24,95 €

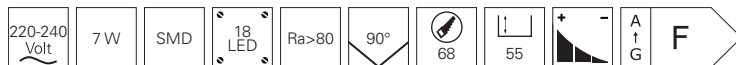

accessories

930652 cover ring black for Acrux 68 **4,95 €**

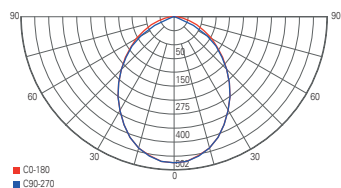

light distribution curve

ACRUX 90

- plastic
- dimensions H x Ø: 58,0 x 113,0 mm
- white basic housing can also be used without coloured cover ring
- incl. optional monterbarer cover [silver coloured or black]
- dimmable via phase control or phase cut-off
- light colour adjustable via dip switch



item	colour	colour temperature	light current	price
565316	<input type="checkbox"/> <input type="checkbox"/> white/silver coloured	<input type="checkbox"/> <input type="checkbox"/> <input type="checkbox"/> 3000/4000/6000 K	760 lm	29,95 €
565363	<input type="checkbox"/> <input type="checkbox"/> white/black	<input type="checkbox"/> <input type="checkbox"/> <input type="checkbox"/> 3000/4000/6000 K	760 lm	29,95 €



accessories

930653 cover ring black for Acrux 80 **5,95 €**

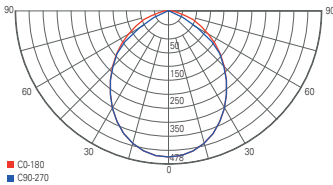

light distribution curve

ACRUX 120

- plastic
- dimensions H x Ø: 65,8 x 145,0 mm
- white basic housing can also be used without coloured cover ring
- incl. optional monterbarer cover [silver coloured or black]
- dimmable via phase control or phase cut-off
- light colour adjustable via dip switch



item	colour	colour temperature	light current	price
565317	<input type="checkbox"/> <input type="checkbox"/> white/silver coloured	<input type="checkbox"/> <input type="checkbox"/> <input type="checkbox"/> 3000/4000/6000 K	1370 lm	34,95 €
565364	<input type="checkbox"/> <input type="checkbox"/> white/black	<input type="checkbox"/> <input type="checkbox"/> <input type="checkbox"/> 3000/4000/6000 K	1370 lm	34,95 €

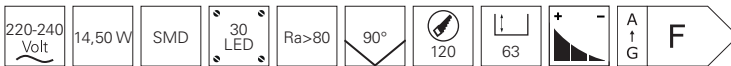

accessories

930654 cover ring black for Acrux 120 **6,95 €**

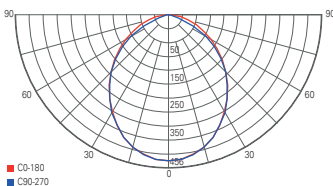

light distribution curve

ACRUX 145

- plastic
- dimensions H x Ø: 68,5 x 174,0 mm
- white basic housing can also be used without coloured cover ring
- incl. optional monterbarer cover [silver coloured or black]
- dimmable via phase control or phase cut-off
- light colour adjustable via dip switch



item	colour	colour temperature	light current	price
565318	<input type="checkbox"/> <input type="checkbox"/> white/silver coloured	<input type="checkbox"/> WW <input type="checkbox"/> NW <input type="checkbox"/> CW 3000/4000/6000 K	1570 lm	39,95 €
565365	<input type="checkbox"/> <input type="checkbox"/> white/black	<input type="checkbox"/> WW <input type="checkbox"/> NW <input type="checkbox"/> CW 3000/4000/6000 K	1570 lm	39,95 €

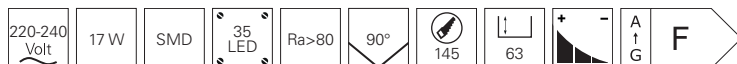

accessories

930655 cover ring black for Acrux 145 **6,95 €**

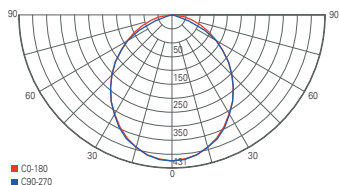

light distribution curve

ACRUX 195

- plastic
- dimensions H x Ø: 84,0 x 244,0 mm
- white basic housing can also be used without coloured cover ring
- incl. optional monterbarer cover [silver coloured or black]
- dimmable via phase control or phase cut-off
- light colour adjustable via dip switch



item	colour	colour temperature	light current	price
565332	<input type="checkbox"/> <input type="checkbox"/> white/silver coloured	<input type="checkbox"/> WW <input type="checkbox"/> NW <input type="checkbox"/> CW 3000/4000/6000 K	2670 lm	54,95 €
565366	<input type="checkbox"/> <input type="checkbox"/> white/black	<input type="checkbox"/> WW <input type="checkbox"/> NW <input type="checkbox"/> CW 3000/4000/6000 K	2670 lm	54,95 €

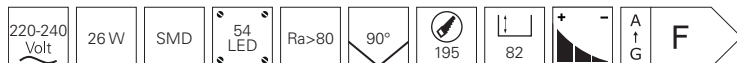

accessories

930656 cover ring black for Acrux 195 **8,95 €**

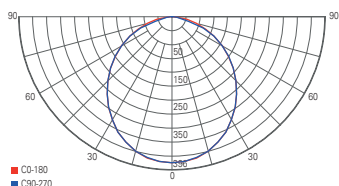

light distribution curve

ZAURAK

Recessed ceiling luminaires can be discreetly integrated into private and commercial spaces, but when they need to be replaced, the existing ceiling cut-out can become a problem. The ZAURAK series comes with an adjustable mounting bracket that allows larger or smaller ceiling cut-outs to be used. In addition, the ZAURAK has a low installation depth for universal use. The scope of delivery includes two interchangeable cover rings in silver and black.



ZAURAK 180

- light colour and output adjustable via dip switch
- white basic housing can also be used without coloured cover ring
- incl. optional cover [silver coloured and black]
- adjustable cut-out dimension: 65-160 mm
- plastic
- dimensions H x Ø: 21 x 180 mm



item	colour	colour temperature	light current	price
565327	<input type="checkbox"/> <input type="checkbox"/> <input checked="" type="checkbox"/> white/silver coloured/black	<input checked="" type="checkbox"/> <input type="checkbox"/> <input type="checkbox"/> 3000/4000/5700 K	1060 lm	46,95 €

220-240 Volt	8/12 W	SMD	52 LED	Ra>80	110°	65	IP44	A ↑ G	G
--------------	--------	-----	--------	-------	------	----	------	-------------	---

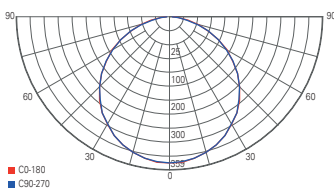

light distribution curve



ZAURAK 220

- light colour and output adjustable via dip switch
- white basic housing can also be used without coloured cover ring
- incl. optional cover [silver coloured and black]
- adjustable cut-out dimension: 120-200 mm
- plastic
- dimensions H x Ø: 22 x 220 mm



item	colour	colour temperature	light current	price
565328	<input type="checkbox"/> <input type="checkbox"/> <input checked="" type="checkbox"/> white/silver coloured/black	<input checked="" type="checkbox"/> <input type="checkbox"/> <input type="checkbox"/> 3000/4000/5700 K	1750 lm	56,95 €

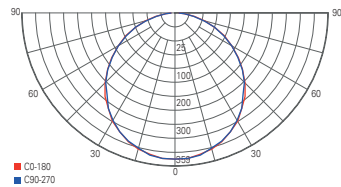
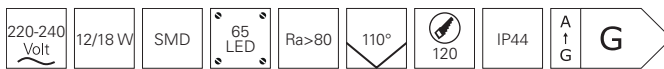

ZAURAK 300

- light colour and output adjustable via dip switch
- white basic housing can also be used without coloured cover ring
- incl. optional cover [silver coloured and black]
- adjustable cut-out dimension: 150-270 mm
- plastic
- dimensions H x Ø: 25 x 300 mm



item	colour	colour temperature	light current	price
565329	<input type="checkbox"/> <input type="checkbox"/> <input checked="" type="checkbox"/> white/silver coloured/black	<input checked="" type="checkbox"/> <input type="checkbox"/> <input type="checkbox"/> 3000/4000/5700 K	2420 lm	79,95 €

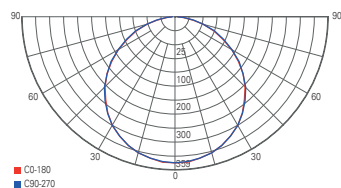
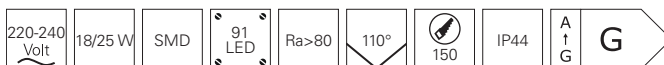



LED PANEL 8 + 12 + 16

- aluminium diecast
- dimmable via optional power supply

item	colour	colour temperature	light current	dimensions H x Ø	Strom	voltage	power	cutout Ø	inst. depth	price
565082		2700 K	590 lm	18 x 145 mm	350 mA	17-18 V	7 W	135 mm	18 mm	39,95 €
565083		2700 K	590 lm	18 x 145 mm	350 mA	17-18 V	7 W	135 mm	18 mm	39,95 €
565084		4000 K	610 lm	18 x 145 mm	350 mA	17-18 V	7 W	135 mm	18 mm	39,95 €
565085		4000 K	610 lm	18 x 145 mm	350 mA	17-18 V	7 W	135 mm	18 mm	39,95 €
565088		2700 K	820 lm	20 x 180 mm	350 mA	23-24 V	9 W	169 mm	20 mm	55,95 €
565089		2700 K	820 lm	20 x 180 mm	350 mA	23-24 V	9 W	169 mm	20 mm	55,95 €
565090		4000 K	870 lm	20 x 180 mm	350 mA	23-24 V	9 W	169 mm	20 mm	55,95 €
565091		4000 K	870 lm	20 x 180 mm	350 mA	23-24 V	9 W	169 mm	20 mm	55,95 €
565094		2700 K	1260 lm	20 x 236 mm	700 mA	17-18 V	13 W	222 mm	20 mm	77,95 €
565095		2700 K	1260 lm	20 x 236 mm	700 mA	17-18 V	13 W	222 mm	20 mm	77,95 €
565096		4000 K	1150 lm	20 x 236 mm	700 mA	17-18 V	13 W	222 mm	20 mm	77,95 €
565097		4000 K	1150 lm	20 x 236 mm	700 mA	17-18 V	13 W	222 mm	20 mm	77,95 €

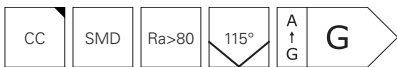

accessories for **565082-565085**

180512	power supply 350 mA 0,7-18,0 W	23,95 €
862202	power supply dimmable 350 mA 3,9-9,0 W	28,95 €
862190	power supply dimmable mit Dali1/Dali2, Intelli-Push 3,2-12,0 W	59,95 €

accessories for **565088-565091**

180512	power supply 350 mA 0,7-18,0 W	23,95 €
862203	power supply dimmable 350 mA 6,3-12,0 W	36,95 €
862190	power supply dimmable mit Dali1/Dali2, Intelli-Push 3,2-12,0 W	59,95 €

accessories for **565094-565097**

180514	power supply 700 mA 1,4-18,0 W	23,95 €
862207	power supply dimmable 700 mA 9,8-20,0 W	39,95 €
862246	power supply dimmable mit Dali1/Dali2 4,2-25,0 W	89,95 €



LED PANEL 8 + 16 + 8

- aluminium diecast
- dimmable and colour temperature adjustable via optional controller

item	colour	colour temperature	light current	dimensions H x Ø	power	cutout Ø	installation depth	price
565102	<input type="checkbox"/> white	ww cw 2700-6000 K	470 lm	18 x 145 mm	8,50 W	135 mm	18 mm	55,95 €
565103	<input type="checkbox"/> white	ww cw 2700-6000 K	940 lm	20 x 236 mm	15,00 W	222 mm	20 mm	85,95 €
565248	<input type="checkbox"/> white	RGB ww 3000 K	140 lm	18 x 145 mm	8,00 W	135 mm	18 mm	55,95 €

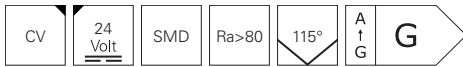

accessories for **565102**

862233	power supply 24V 12,00 W	21,95 €
862166	power supply 24V 100,00 W	96,95 €
843501	RF-smart controller starter set CCT 12/24/48V	99,95 €

accessories for **565103**

862234	power supply 24V 20,00 W	25,95 €
862168	power supply 24V 150,00 W	129,95 €
843501	RF-smart controller starter set CCT 12/24/48V	99,95 €

accessories for **565248**

862233	power supply 24V 12,0 W	21,95 €
862166	power supply 24V 100,0 W	96,95 €
843502	RF-smart controller starter set RGBW 12/24/48V	99,95 €



With the kind support of Salvia Elektrotechnik GmbH



LED PANEL ROUND III 6 + 12

- aluminium diecast
- dimmable via optional power supply

item	colour	colour temperature	light current	dimensions H x Ø	voltage	power	cutout Ø	inst. depth	price
565229	<input type="checkbox"/> white	<input checked="" type="checkbox"/> WW 3000 K	620 lm	34 x 106 mm	18 V	6 W	90 mm	32 mm	59,95 €
565230	<input type="checkbox"/> white	<input checked="" type="checkbox"/> NW 4000 K	630 lm	34 x 106 mm	18 V	6 W	90 mm	32 mm	59,95 €
565231	<input type="checkbox"/> white	<input checked="" type="checkbox"/> WW 3000 K	1310 lm	36 x 140 mm	36 V	13 W	125 mm	34 mm	79,95 €
565232	<input type="checkbox"/> white	<input checked="" type="checkbox"/> NW 4000 K	1320 lm	36 x 140 mm	36 V	13 W	125 mm	34 mm	79,95 €

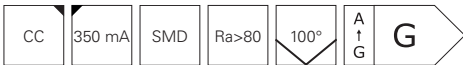

accessories for **565229, 565230**

862223	power supply 350 mA 2-35V 0,7-12,0 W	24,95 €
862202	power supply dimmable 350 mA 11-26V 3,9-9,0 W	28,95 €
862190	power supply MULTI-CC DALI1/2/Intelli-Push dimmable 15-34V 5,2-12,0 W	59,95 €

accessories for **565231, 565232**

180512	power supply 350 mA 2-52V 0,7-18,0 W	23,95 €
862204	power supply dimmable 350 mA 28-57V 9,8-20,0 W	39,95 €
862191	power supply MULTI-CC DALI DALI1/2/Intelli-Push dimmable 20-60V 7,0-20,0 W	64,95 €



LED PANEL ROUND III 20 + 26

- aluminium diecast
- dimmable via optional power supply

item	colour	colour temperature	light current	dimensions H x Ø	voltage	power	cutout Ø	inst. depth	price
565233	<input type="checkbox"/> white	<input checked="" type="checkbox"/> WW 3000 K	1980 lm	38 x 180 mm	28 V	20 W	160 mm	36 mm	99,95 €
565234	<input type="checkbox"/> white	<input checked="" type="checkbox"/> NW 4000 K	1970 lm	38 x 180 mm	28 V	20 W	160 mm	36 mm	99,95 €
565235	<input type="checkbox"/> white	<input checked="" type="checkbox"/> WW 3000 K	2680 lm	38 x 230 mm	37 V	26 W	200 mm	36 mm	109,95 €
565236	<input type="checkbox"/> white	<input checked="" type="checkbox"/> NW 4000 K	2690 lm	38 x 230 mm	37 V	26 W	200 mm	36 mm	109,95 €

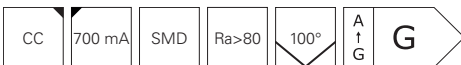

accessories for **565233, 565234**

862198	power supply 700 mA 21-43V 14,7-30,0 W	26,95 €
862207	power supply dimmable 700 mA 14,0-28,0V 9,8-20,0 W	39,95 €
862191	power supply MULTI-CC DALI DALI1/2/Intelli-Push dimmable 20-36V 14,0-25,0 W	64,95 €

accessories for **565235, 565236**

862198	power supply 700 mA 21-43V 14,7-30,0 W	26,95 €
862208	power supply dimmable 700 mA 28-56V 19,6-40,0 W	46,95 €
862192	power supply MULTI-CC DALI1/2/Intelli-Push dimmable 25-64V 17,5-45,0 W	69,95 €

IP



COB 68 IP65

- aluminium diecast
- dimensions H x Ø: 44 x 78 mm
- dimmable via optional power supply

item	colour	colour temperature	light current	EEL	price
565108	<input type="checkbox"/> white	2700 K	670 lm	G	59,95 €
565109	<input type="checkbox"/> grey	2700 K	670 lm	G	59,95 €
565110	<input type="checkbox"/> white	4200 K	730 lm	G	59,95 €
565111	<input type="checkbox"/> grey	4200 K	730 lm	E	59,95 €

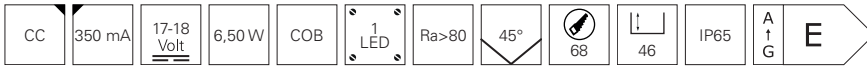

accessories

829063	safety spacer	5,95 €
180512	power supply 350 mA 0,7-18,0 W	23,95 €
862202	power supply dimmable 350 mA 3,9 - 9 ,0 W	28,95 €

IP



PUNTO LUMI

- aluminium
- dimensions H x Ø: 25 x 30 mm

item	colour	colour temperature	light current	price
565172	<input type="checkbox"/> white	3000 K	40 lm	17,95 €
565173	<input type="checkbox"/> silver coloured chrome	3000 K	40 lm	17,95 €



accessories

872628	power supply 350 mA 0,7 - 6,0 W	17,95 €
---------------	-------------------------------------	----------------



COB 68 HCL

- aluminium
- dimensions H x Ø: 46 x 78 mm
- dimmable and colour temperature adjustable via optional controller
- swivelling

item	colour	colour temperature	light current	price
565193	<input type="checkbox"/> white	2500-6500 K	534 lm	64,95 €
565198	<input type="checkbox"/> silver coloured brushed	2500-6500 K	700 lm	64,95 €



accessories

829063	safety spacer	5,95 €
862233	power supply 24V DC 12,0 W	21,95 €
862166	power supply 24V DC 100,0 W	96,95 €
843501	RF-smart controller starter set CCT 12/24/48V	99,95 €
843051	DALI DT6 PWM dimmer 2 channel / 12/24V	109,95 €
843071	DALI DT8 PWM dimmer 2 channel / 12/24V	109,95 €



COB 95 HCL

- aluminium
- dimensions H x Ø: 65 x 108 mm
- dimmable and colour temperature adjustable via optional controller
- swivelling

item	colour	colour temperature	light current	price
565194	<input type="checkbox"/> white	2500-6500 K	1118 lm	109,95 €



accessories

829063	safety spacer	5,95 €
862234	power supply 24V DC 20,0 W	25,95 €
862168	power supply 24V DC 150,0 W	129,95 €
843501	RF-smart controller starter set CCT 12/24/48V	99,95 €
843051	DALI DT6 PWM dimmer 2 channel / 12/24V	109,95 €
843071	DALI DT8 PWM dimmer 2 channel / 12/24V	109,95 €



COB 68 ACRYL

A spotlight with that certain something: thanks to its acrylic ring, the COB 68 ACRYL emits light not only downwards but also softly to the side. The resulting play of light on the ceiling makes for a discreet but effective eye-catcher and bathes every room in a cosy ambience.



COB 68 ACRYL HCL

- acrylic glass, aluminium
- dimensions H x Ø: 60 x 78 mm
- dimmable and colour temperature adjustable via optional controller



item	colour	colour temperature	light current	price
565247	colourless satined	2400-6500 K	590 lm	65,95 €

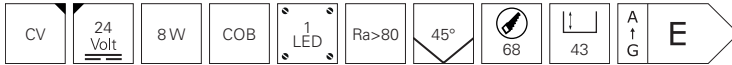

accessories

930270	acrylic ring round 90 mm	19,95 €	
930271	acrylic ring angular 90 x 90 mm	19,95 €	
829063	safety spacer	5,95 €	
862233	power supply 24V DC 12,0 W	21,95 €	
862166	power supply 24V DC 100,0 W	96,95 €	
843501	RF-smart controller starter set CCT 12/24/48V	99,95 €	
843051	DALI DT6 PWM dimmer 2 channel / 12/24V	109,95 €	
843071	DALI DT8 PWM dimmer 2 channel / 12/24V	109,95 €	

COB 68 ACRYL

- acrylic glass, aluminium
- dimensions H x Ø: 54 x 78 mm
- dimmable via optional power supply



item	colour	colour temperature	light current	price
565195	colourless satined	2700 K	675 lm	65,95 €

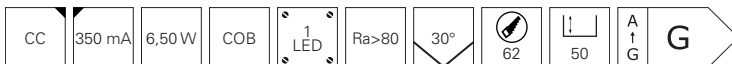

accessories

930270	acrylic ring round 90 mm	19,95 €	
930271	acrylic ring angular 90 x 90 mm	19,95 €	
829063	safety spacer	5,95 €	
180512	power supply 350 mA 0,7-18,0 W	23,95 €	
862202	power supply dimmable 350 mA 3,9 - 9 ,0 W	28,95 €	

DIONE

The new DIONE series comprises elegant recessed spotlights in aluminium housing with particularly shallow mounting depth - a real problem solver in the refurbishment sector.

The popular DIONE recessed ceiling luminaires with high-quality COB LED including reflector are housed in an aluminium casing and have a cut-out dimension of 68 mm. While the available colours white, silver, black, chrome and nickel harmonise with almost any type of ceiling, the actual special feature of the DIONE is not visible when installed: The recessed spotlights are extremely space-saving when installed and require only 25 or 27 mm of ceiling cavity. This is where the power supply unit and the Quick connection box are located, which allows 3-pole through-wiring of several DIONE models as well as retrofitting as part of renovations.

The plug-in connector between the spotlight and the power supply unit allows installers to conveniently install the lighting equipment and connect the spotlight once the ceiling work has been completed.

The DIONE recessed spotlights are available in the light colours 2,700K, 3,000 K, 4,000 K and as a dim-to-warm version [1,800- 3,000K]. In addition to the IP20 version, an IP44 version is also available, making the DIONE suitable for bathrooms and other damp areas indoors.

With this variety, the DIONE series offers recessed spotlights for a wide range of applications - from private homes and exhibition areas to guest areas in hotels and restaurants. Thanks to the wide selection of light colours and IP classes, the DIONE can be flexibly integrated into any environment and covers all design requirements, from a feel-good character to functional lighting.



THAT'S HOW EASY IT IS



1 - Quick wiring / through-wiring on the Quick connection box due to screwless plug-in terminals



2 - quick connection box is placed over the 68 mm cut-out in the cavity



3 - compact power supply unit is inserted into the cavity



4 - connect the power supply unit to the spot using the connector



5 - inserting the spot into the ceiling cut-out



6 - The result: a compact installation with a swivelling spot, a dimmable power supply unit and the option of through-wiring in the ceiling cavity - ideal in refurbishment areas.

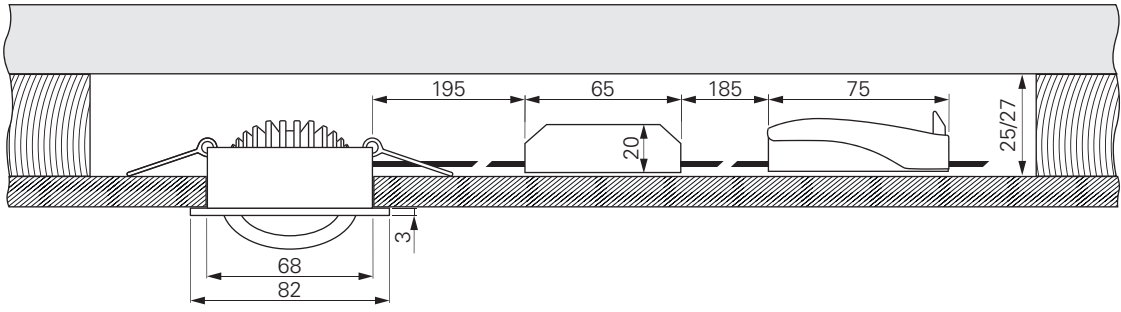



DIONE IP20

- aluminium
- dimensions H x Ø: 41 x 82 mm
- through-wiring also possible with NYM 3x 1.5 m²
- quick installation through Quick-Terminal
- dimmable via phase cut-off [C-suitable/compatible]

Quick-Terminal
with possibility for
through-wiring

item	colour	colour temperature	light current	required ceiling cavity [min.]	EEL	price
565375	white	2700 K	750 lm	25 mm	E	59,95 € NEW
565376	silver coloured	2700 K	750 lm	25 mm	E	59,95 € NEW
565377	black	2700 K	750 lm	25 mm	E	59,95 € NEW
565379	chrome	2700 K	750 lm	25 mm	E	59,95 € NEW
565378	nickel brushed	2700 K	750 lm	25 mm	E	59,95 € NEW
565355	white	3000 K	800 lm	25 mm	E	59,95 €
565356	silver coloured	3000 K	800 lm	25 mm	E	59,95 €
565357	black	3000 K	800 lm	25 mm	E	59,95 €
565372	chrome	3000 K	800 lm	25 mm	E	59,95 € NEW
565371	nickel brushed	3000 K	800 lm	25 mm	E	59,95 € NEW
565358	white	4000 K	800 lm	25 mm	E	59,95 €
565359	silver coloured	4000 K	800 lm	25 mm	E	59,95 €
565360	black	4000 K	800 lm	25 mm	E	59,95 €
565374	chrome	4000 K	800 lm	25 mm	E	59,95 € NEW
565373	nickel brushed	4000 K	800 lm	25 mm	E	59,95 € NEW
565380	white	1800-3000 K	480 lm	25 mm	F	69,95 € NEW
565381	silver coloured	1800-3000 K	480 lm	25 mm	F	69,95 € NEW
565382	black	1800-3000 K	480 lm	25 mm	F	69,95 € NEW
565383	chrome	1800-3000 K	480 lm	25 mm	F	69,95 € NEW
565384	nickel brushed	1800-3000 K	480 lm	25 mm	F	69,95 € NEW



accessories when using insulating material [creates the necessary distance]

829063 safety spacer

5,95 €



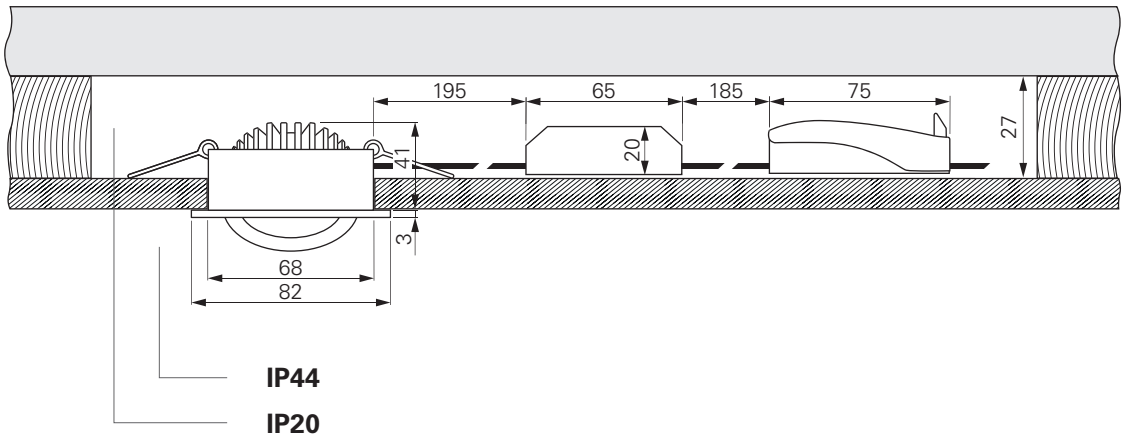



Quick-Terminal
with possibility for
through-wiring

DIONE IP44/IP20

- aluminium
- dimensions H x Ø: 41 x 82 mm
- through-wiring also possible with NYM 3x 1.5 m²
- quick installation through Quick-Terminal
- dimmable via phase cut-off [C-suitable/compatible]

item	colour	colour temperature	light current	required ceiling cavity [min.]	EEL	price
565388	<input type="checkbox"/> white	2700 K	750 lm	27 mm	E	64,95 €
565389	<input type="checkbox"/> silver coloured	2700 K	750 lm	27 mm	E	64,95 €
565390	<input type="checkbox"/> black	2700 K	750 lm	27 mm	E	64,95 €
565391	<input type="checkbox"/> chrome	2700 K	750 lm	27 mm	E	64,95 €
565392	<input type="checkbox"/> nickel brushed	2700 K	750 lm	27 mm	E	64,95 €
565393	<input type="checkbox"/> white	3000 K	800 lm	27 mm	E	64,95 €
565394	<input type="checkbox"/> silver coloured	3000 K	800 lm	27 mm	E	64,95 €
565395	<input type="checkbox"/> black	3000 K	800 lm	27 mm	E	64,95 €
565396	<input type="checkbox"/> chrome	3000 K	800 lm	27 mm	E	64,95 €
565397	<input type="checkbox"/> nickel brushed	3000 K	800 lm	27 mm	E	64,95 €
565398	<input type="checkbox"/> white	4000 K	800 lm	27 mm	E	64,95 €
565399	<input type="checkbox"/> silver coloured	4000 K	800 lm	27 mm	E	64,95 €
565400	<input type="checkbox"/> black	4000 K	800 lm	27 mm	E	64,95 €
565401	<input type="checkbox"/> chrome	4000 K	800 lm	27 mm	E	64,95 €
565402	<input type="checkbox"/> nickel brushed	4000 K	800 lm	27 mm	E	64,95 €
565403	<input type="checkbox"/> white	1800-3000 K	480 lm	27 mm	F	74,95 €
565404	<input type="checkbox"/> silver coloured	1800-3000 K	480 lm	27 mm	F	74,95 €
565405	<input type="checkbox"/> black	1800-3000 K	480 lm	27 mm	F	74,95 €
565406	<input type="checkbox"/> chrome	1800-3000 K	480 lm	27 mm	F	74,95 €
565407	<input type="checkbox"/> nickel brushed	1800-3000 K	480 lm	27 mm	F	74,95 €



accessories when using insulating material [creates the necessary distance]

829063

safety spacer

5,95 €





COB 94 RGBW

- aluminium diecast
- dimensions H x Ø: 70 x 110 mm
- dimmable via optional controller
- swivelling



item	colour	colour temperature	light current	price
565245	<input type="checkbox"/> grey	3000 K	710 lm	129,95 €
565246	<input type="checkbox"/> silver coloured brushed	3000 K	710 lm	129,95 €



accessories

829063	safety spacer	5,95 €
862234	power supply 24V 20,0 W	25,95 €
862166	power supply 24V 100,0 W	96,95 €
843502	RF-smart controller starter set RGBW 12/24/48V	99,95 €
843010	DALI DT6 PWM dimmer RGBW 12/24V	129,95 €





COB-68-350MA-2700K-ANGULAR

- aluminium
- dimensions L x B x H: 78 x 78 x 46 mm
- dimmable via optional power supply
- swivelling

item	colour	colour temperature	light current	EEL	price
565283	<input type="checkbox"/> white	ww 2700 K	580 lm	E	59,95 €
565282	<input type="checkbox"/> silver coloured brushed	ww 2700 K	580 lm	E	59,95 €
565285	<input type="checkbox"/> white	nw 4000 K	660 lm	E	59,95 €
565284	<input type="checkbox"/> silver coloured brushed	nw 4000 K	660 lm	D	59,95 €

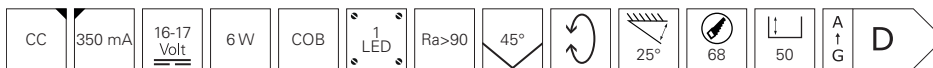

accessories

829063	safety spacer	5,95 €
180512	power supply 350 mA 0,7-18,0 W	26,95 €
862202	power supply dimmable 350 mA 3,9-9,0 W	31,95 €



COB 68 RGBW

- aluminium
- dimensions H x Ø: 46 x 78 mm
- dimmable via optional controller
- swivelling

item	colour	colour temperature	light current	price
565335	<input type="checkbox"/> white	RGB WW 3000 K	500 lm	99,95 €
565336	<input type="checkbox"/> silver coloured brushed	RGB WW 3000 K	500 lm	99,95 €



accessories

829063	safety spacer	5,95 €
862233	power supply 24V 12,0 W	21,95 €
862122	power supply 24V DC 50,0 W	52,95 €
843502	RF-smart controller starter set RGBW 12/24/48V	99,95 €
843010	DALI DT6 PWM dimmer RGBW 12/24V	129,95 €

SMD-68-230V-RUND

A lot of power for a small price! The recessed luminaires of the SMD-68 series provide up to 550 lm and also have an integrated, dimmable power supply unit [230V direct connection], which makes the use of GU10 sockets and retrofit upgrades unnecessary.



SMD-68-230V-ROUND

- plastic
- dimensions H x Ø: 44 x 85 mm
- dimmable via phase control or phase cut-off
- swivelling

item	colour	colour temperature	light current	EEl	price
565337	white	2700 K	510 lm G		19,95 €
565385	black	2700 K	510 lm G		19,95 € NEW
565338	white	3000 K	540 lm F		19,95 €
565386	black	3000 K	540 lm F		19,95 € NEW
565339	white	4000 K	550 lm G		19,95 €
565387	black	4000 K	550 lm G		19,95 € NEW







COB 95

- aluminium
- dimensions H x Ø: 53 x 110 mm
- dimmable via optional power supply
- incl. 2 plastic panes [clear, satined]
- plug on the housing

item	colour	colour temperature	light current	EEL	price
565007	<input type="checkbox"/> white	3000 K	1100 lm	F	89,95 €
565010	<input type="checkbox"/> white	4000 K	1100 lm	G	89,95 €



accessories

180512	power supply 350 mA 2-52V 0,7-18,0 W	23,95 €
862204	power supply dimmable 350 mA 28-57V 9,8-20,0 W	39,95 €
862191	power supply MULTI-CC DALI1/2/Intelli-Push dimmable 20-60V 7,0-20,0 W	64,95 €



COB 130

- aluminium
- dimensions H x Ø: 69 x 145 mm
- dimmable via optional power supply
- incl. 2 plastic panes [clear, satined]
- plug on the housing

item	colour	colour temperature	light current	price
565180	<input type="checkbox"/> white	3000 K	1360 lm	109,95 €
565181	<input type="checkbox"/> white	4000 K	1450 lm	109,95 €



accessories

862226	power supply 500 mA 2-40V 1,0-20,0 W	28,95 €
862205	power supply dimmable 500 mA 20-40V 10,0-20,0 W	39,95 €
862191	power supply MULTI-CC DALI1/2/Intelli-Push dimmable 20-50V 10,0-25,0 W	64,95 €



COB 170

- aluminium
- dimensions H x Ø: 86 x 190 mm
- dimmable via optional power supply
- incl. 2 plastic panes [clear, satined]
- plug on the housing

item	colour	colour temperature	light current	price
565182	<input type="checkbox"/> white	3000 K	2100 lm	139,95 €
565183	<input type="checkbox"/> white	4000 K	2100 lm	139,95 €



accessories

862198	power supply 700 mA 21-43V 14,7-30,0 W	26,95 €
862208	power supply dimmable 700 mA 28-56V 19,6-40,0 W	46,95 €
862192	power supply MULTI-CC DALI1/2/Intelli-Push dimmable 25-64V 17,5-45,0 W	69,95 €



COB 210

- aluminium
- dimensions H x Ø: 99 x 230 mm
- dimmable via optional power supply
- incl. 2 plastic panes [clear, satined]
- plug on the housing

item	colour	colour temperature	light current	price
565184	<input type="checkbox"/> white	3000 K	3000 lm	179,95 €
565185	<input type="checkbox"/> white	4000 K	3200 lm	179,95 €



accessories

862201	power supply 1050 mA 19-38V 20,0-40,0 W	29,95 €
862209	power supply dimmable 1050 mA 19-38V 20,0-40,0 W	46,95 €
862193	power supply MULTI-CC DALI1/2/Intelli-Push dimmable 14-43V 14,7-45,0 W	69,95 €



ALYA

- LED-power supply integrated in the housing
- plastic
- dimmable via phase control or phase cut-off
- incl. connection box with through-wiring

item	colour	colour temperature	light current	power	dimensions H x Ø / L x B x H	cutout Ø / L x B	price
565320	<input type="checkbox"/> white	2700 K	540 lm	7,50 W	10 x 120 mm	100 mm	21,95 €
565367	<input type="checkbox"/> white	3000 K	555 lm	7,50 W	10 x 120 mm	100 mm	21,95 €
565321	<input type="checkbox"/> white	2700 K	540 lm	7,50 W	120 x 120 x 10 mm	105 x 105 mm	24,95 €
565368	<input type="checkbox"/> white	3000 K	555 lm	7,50 W	120 x 120 x 10 mm	105 x 105 mm	24,95 €
565322	<input type="checkbox"/> white	2700 K	960 lm	11,50 W	10 x 180 mm	150 mm	28,95 €
565369	<input type="checkbox"/> white	3000 K	990 lm	11,50 W	10 x 180 mm	150 mm	28,95 €
565323	<input type="checkbox"/> white	2700 K	960 lm	11,50 W	180 x 180 x 10 mm	155 x 155 mm	30,95 €
565370	<input type="checkbox"/> white	3000 K	990 lm	11,50 W	180 x 180 x 10 mm	155 x 155 mm	30,95 €

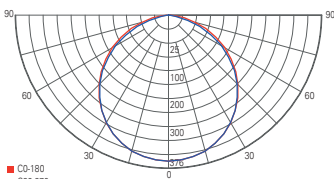
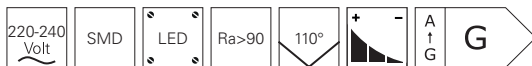

light distribution curve 565320, 565367

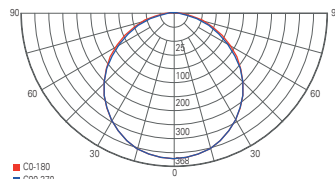

light distribution curve 565322, 565369

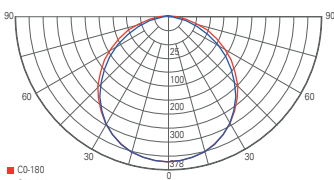

light distribution curve 565321, 565368

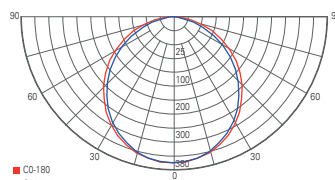

light distribution curve 565323, 565370



LED PANEL SQUARE 8 + 15 + 20

- aluminium diecast
- dimensions L x B x H: 237 x 237 x 20 mm
- dimmable via optional power supply

item	colour	colour temp.	light current	dimensions L x B x H	Strom/voltage	power	cutout L x B	EEL	price
565152	<input type="checkbox"/> white	2700 K	560 lm	110 x 110 x 23,5 mm	350 mA/18-19 V	7 W	90 x 90 mm	G	34,95 €
565153	<input type="checkbox"/> grey	2700 K	560 lm	110 x 110 x 23,5 mm	350 mA/18-19 V	7 W	90 x 90 mm	G	34,95 €
565154	<input type="checkbox"/> white	4000 K	560 lm	110 x 110 x 23,5 mm	350 mA/18-19 V	7 W	90 x 90 mm	G	34,95 €
565155	<input type="checkbox"/> grey	4000 K	560 lm	110 x 110 x 23,5 mm	350 mA/18-19 V	7 W	90 x 90 mm	G	34,95 €
565156	<input type="checkbox"/> white	2700 K	1000 lm	180 x 180 x 21,0 mm	350 mA/36-37 V	13 W	115 x 115 mm	G	59,95 €
565157	<input type="checkbox"/> grey	2700 K	1000 lm	180 x 180 x 21,0 mm	350 mA/36-37 V	13 W	115 x 115 mm	G	59,95 €
565158	<input type="checkbox"/> white	4000 K	1130 lm	180 x 180 x 21,0 mm	350 mA/36-37 V	13 W	115 x 115 mm	F	59,95 €
565159	<input type="checkbox"/> grey	4000 K	1130 lm	180 x 180 x 21,0 mm	350 mA/36-37 V	13 W	115 x 115 mm	G	59,95 €
565160	<input type="checkbox"/> white	2700 K	1560 lm	237 x 237 x 20 mm	700 mA/23-24 V	17 W	215 x 215 mm	G	74,95 €
565161	<input type="checkbox"/> grey	2700 K	1560 lm	237 x 237 x 20 mm	700 mA/23-24 V	17 W	215 x 215 mm	G	74,95 €
565162	<input type="checkbox"/> white	4000 K	1740 lm	237 x 237 x 20 mm	700 mA/23-24 V	17 W	215 x 215 mm	G	74,95 €
565163	<input type="checkbox"/> grey	4000 K	1740 lm	237 x 237 x 20 mm	700 mA/23-24 V	17 W	215 x 215 mm	G	74,95 €



accessories for **5651252, 565153, 565154, 565155**

862223	power supply 350 mA 2-35V 0,7-12,0 W	24,95 €
862202	power supply dimmable 350 mA 11-26V 3,9-9,0 W	28,95 €
862190	power supply MULTI-CC DALI1/2/Intelli-Push dimmable 15-34V 4,2-12,0 W	59,95 €

accessories for **5651256, 565157, 565158, 565159**

180512	power supply 350 mA 2-52V 0,7-18,0 W	23,95 €
862204	power supply dimmable 350 mA 28-57V 9,8-20,0 W	39,95 €
862191	power supply MULTI-CC DALI1/2/Intelli-Push dimmable 20-60V / 7,0-20,0 W	64,95 €

accessories for **5651260, 565161, 565162, 565163**

180514	power supply 700 mA 2-26V 1,4-18,0 W	23,95 €
862207	power supply dimmable 700 mA 14-28V 9,8-20,0 W	39,95 €
862191	power supply MULTI-CC DALI1/2/Intelli-Push dimmable 20-36V 14,0-25,0 W	64,95 €



UNI II

- aluminium diecast
- dimensions H x Ø: 84 x 139 mm
- dimmable via optional power supply
- rotatable and swivelling

suitable surface-mounted ceiling luminaires from page 72

item	colour	colour temperature	light current	price
565343	white	3000 K	1035 lm	119,95 €
565361	black	3000 K	1035 lm	119,95 €

348124
348179
348125
348175
348107
348210

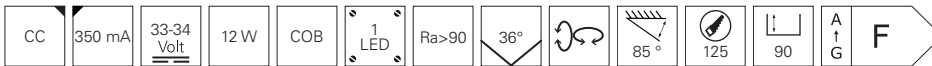

suitable wall-mounted luminaires page 171
341215
341232



suitable power luminaire page 352
707044
707131

accessories

930339	reflector ring black	10,95 €
930340	reflector ring gold	10,95 €
930341	reflector ring chrome	10,95 €
930371	reflector ring II black	10,95 €
930336	cover heatsink white	3,55 €
930337	cover heatsink black	7,95 €
930306	reflector 48°	8,95 €
930307	honeycomb filter	8,95 €
930308	spread lens 40° clear/satined	8,95 €
930309	softening lens 48° satined	8,95 €
930310	linear spread lens 40°/80° asymmetric clear/satined	8,95 €
180512	power supply 350 mA 2-52V 0,7-18,0 W	23,95 €
862204	power supply dimmable 350 mA 28-57V 9,8-20,0 W	39,95 €
862191	power supply MULTI-CC DALI DALI1/2/Intelli-Push dimmable 20-60V 7,0-20,0 W	64,95 €

UNI II MINI

- aluminium diecast
- dimensions H x Ø: 80 x 103 mm
- dimmable via optional power supply
- rotatable and swivelling



item	colour	colour temperature	light current	price
565342	□ white	www 3000 K	670 lm	99,95 €
565354	■ black	www 3000 K	670 lm	99,95 €

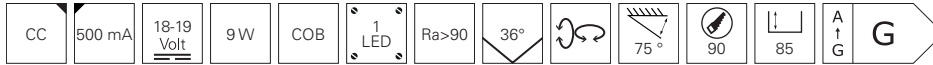

accessories

930331	reflector ring black	10,95 €
930332	reflector ring gold	10,95 €
930333	reflector ring chrome	10,95 €
930381	reflector ring II black	10,95 €
930328	cover heatsink white	3,55 €
930329	cover heatsink black	2,95 €
930770	reflector 24°	10,95 €
930771	reflector 48°	10,95 €
180513	power supply 500 mA 2-38V 1,0-18,0 W	23,95 €
862236	power supply dimmable 500 mA 12-24V 6,0-12,0 W	29,95 €
862190	power supply MULTI-CC DALI1/2/Intelli-Push dimmable 15-24V 7,5-12,0 W	59,95 €

UNI II MAX

- aluminium diecast
- dimensions H x Ø: 97 x 165 mm
- dimmable via optional power supply
- rotatable and swivelling



item	colour	colour temperature	light current	price
565344	□ white	www 3000 K	2150 lm	149,95 €
565351	■ black	www 3000 K	2150 lm	149,95 €



accessories

930397	reflector ring white	12,95 €
930398	reflector ring black	10,95 €
930399	reflector ring gold	14,95 €
930382	reflector ring II black	10,95 €
930395	cover heatsink white	10,95 €
930396	cover heatsink black	10,95 €
930390	reflector 24°	10,95 €
930391	reflector 36°	12,95 €
930392	reflector 48°	10,95 €
862198	power supply 700 mA 21-43V 14,7-30,0 W	26,95 €
862208	power supply dimmable 700 mA 28-56V 19,6-40,0 W	46,95 €
862192	power supply MULTI-CC DALI1/2/Intelli-Push dimmable 25-64V 17,5-45,0 W	69,95 €

MODULAR SYSTEM COB

The MODULAR family of recessed ceiling luminaires offers a wide range of applications. Whether almost invisible or with a present frame – these modules are as flexible as you want them to be. By exchanging the reflectors, different light cones can be created and by using filters / diffusers, you can individually select or retrofit your lighting mood. We offer the LED modules in warm and neutral white. This gives you the option of adapting the individual elements to local requirements in order to create your perfect lighting situation.



MODULAR SYSTEM COB 31W

- aluminium diecast
- dimensions H x Ø: 116 x 93 mm
- dimmable via optional power supply



item	colour	colour temperature	light current	price
565352	black	3000 K	3270 lm	119,95 €
565353	black	4000 K	3350 lm	119,95 €

CC	900 mA	35-36 Volt	31 W	COB	1 LED	Ra>90	60°	A t G	E
----	--------	------------	------	-----	-------	-------	-----	-------	---

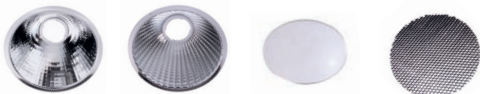

accessories

930084	reflector 17°	14,95 €
930085	reflector 40°	14,95 €
930087	diffusor gefrostet	1,25 €
930088	honeycomb filter	5,95 €
862157	power supply basic 900 mA 22-44V 19,8-40,0 W	29,95 €
862264	Power supply dimmable 900 mA 22-44V 19,6-40,0 W	46,95 €
862192	power supply MULTI-CC DALI1/2/Intelli-Push dimmable 25-50V 22,5-45,0 W	69,95 €



accessories **built-in ring fixed**

- 930089** white | H x Ø: 50 x 170 mm | cut-out size Ø: 150 mm
- 930090** white | H x Ø: 80 x 230 mm | cut-out size Ø: 220 mm

22,95 €

29,95 €



accessories **built-in ring transversable**

- 930091** white | H x Ø: 30 x 130 mm | cut-out size: 115 mm

32,95 €



accessories **gimbal frame transversable**

- 930092** 1er gimbal frame | white | L x B x H: 140 x 140 x 43 mm | cut-out size: 130 x 130 mm
- 930093** 2er gimbal frame | white | L x B x H: 257 x 140 x 43 mm | cut-out size: 240 x 130 mm

36,95 €

66,95 €



accessories **gimbal frame transversable | without frame**

- 930094** 1er gimbal frame | white | L x B x H: 178 x 120 x 50 mm | cut-out size: 120 x 120 mm
- 930095** 1er gimbal frame | black | L x B x H: 178 x 120 x 50 mm | cut-out size: 120 x 120 mm
- 930096** 2er gimbal frame | white | L x B x H: 305 x 120 x 50 mm | cut-out size: 247 x 120 mm
- 930097** 2er gimbal frame | black | L x B x H: 305 x 120 x 50 mm | cut-out size: 247 x 120 mm

89,95 €

89,95 €

115,95 €

115,95 €



CETI 5

- aluminium diecast
- dimensions L x B x H: 137 x 52 x 44 mm
- dimmable via optional power supply

item	colour	colour temperature	light current	price
565250	white, black	3000 K	800 lm	109,95 €



accessories

930218	reflector silver coloured	9,95 €
930215	reflector gold optics	9,95 €
862227	power supply 700 mA 2-17V 1,4-12,0 W	24,95 €
862237	power supply dimmable 700 mA 10-17V 7,0-12,0 W	29,95 €



CETI 10

- aluminium diecast
- dimensions L x B x H: 257 x 52 x 44 mm
- dimmable via optional power supply

item	colour	colour temperature	light current	price
565251	white, black	3000 K	1600 lm	179,95 €



accessories

930219	reflector silver coloured	10,95 €
930216	reflector gold optics	10,95 €
862198	power supply 700 mA 13-43V 14,7-30,0 W	26,95 €
862207	power supply dimmable 700 mA 14,0-28,0V 9,8-20,0 W	39,95 €
862191	power supply MULTI-CC DALI DALI1/2/Intelli-Push dimmable 20-36V 5,0-25,0 W	64,95 €



CETI 15

- aluminium diecast
- dimensions L x B x H: 376 x 52 x 44 mm
- dimmable via optional power supply

item	colour	colour temperature	light current	price
565252	white, black	3000 K	2400 lm	249,95 €

CC	700 mA	44-45 Volt	30 W	SMD	15 LED	Ra>90	45°	369x36	50	A ↑ G	G
----	--------	------------	------	-----	--------	-------	-----	--------	----	-------------	---

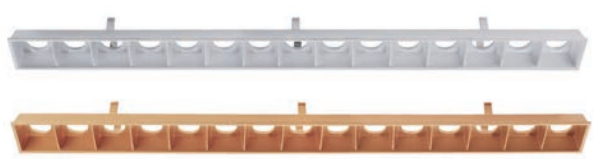

accessories

930220	reflector silver coloured	14,95 €
930217	reflector gold optics	14,95 €
862199	power supply 700 mA 20-57V 20,3-40,0 W	29,95 €
862208	power supply dimmable 700 mA 28-56V 19,6-40,0 W	46,95 €
862192	power supply MULTI-CC DALI1/2/Intelli-Push dimmable 25-64V 17,5-45,0W	69,95 €





CETI 5 HIDE

- aluminium diecast
- dimensions L x B x H: 131 x 56 x 110 mm
- dimmable via optional power supply

item	colour	colour temperature	light current	price
565253	■ black	ww 3000 K	800 lm	129,95 €

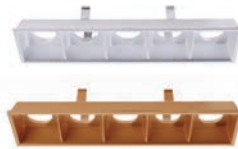

accessories

930218	reflector silver coloured	9,95 €
930215	reflector gold optics	9,95 €
862227	power supply 700 mA 2-17V 1,4-12,0 W	24,95 €
862237	power supply dimmable 700 mA 10-17V 7,0-12,0 W	29,95 €



CETI 10 HIDE

- aluminium diecast
- dimensions L x B x H: 251 x 56 x 110 mm
- dimmable via optional power supply

item	colour	colour temperature	light current	price
565254	■ black	ww 3000 K	1600 lm	199,95 €

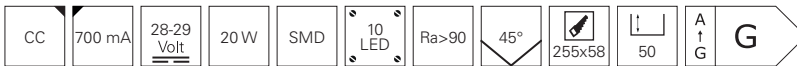

accessories

930219	reflector silver coloured	10,95 €
930216	reflector gold optics	10,95 €
862198	power supply 700 mA 13-43V 14,7-30,0 W	26,95 €
862207	power supply dimmable 700 mA 14,0-28,0V 9,8-20,0 W	39,95 €
862191	power supply MULTI-CC DALI DALI1/2/Intelli-Push dimmable 20-36V 5,0-25,0 W	64,95 €



CETI 15 HIDE

- aluminium diecast
- dimensions L x B x H: 370 x 56 x 110 mm
- dimmable via optional power supply



item	colour	colour temperature	light current	price
565255	black	3000 K	2400 lm	259,95 €

CC	700 mA	44-45 Volt	30 W	SMD	15 LED	Ra>90	45°	375x58	50	A t G	G
----	--------	------------	------	-----	--------	-------	-----	--------	----	-------------	---

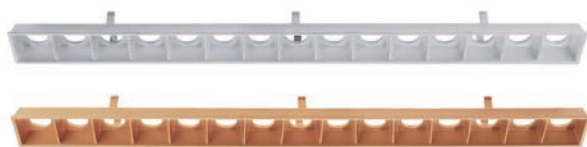

accessories

930220	reflector silver coloured	14,95 €
930217	reflector gold optics	14,95 €
862199	power supply 700 mA 20-57V 20,3-40,0 W	29,95 €
862208	power supply dimmable 700 mA 28-56V 19,6-40,0 W	46,95 €
862192	power supply MULTI-CC DALI1/2/Intelli-Push dimmable 25-64V 17,5-45,0W	69,95 €





CETI 5 ADJUST

- aluminium diecast
- dimensions L x B x H: 155 x 77 x 83 mm
- dimmable via optional power supply
- swivelling and extendable

item	colour	colour temperature	light current	price
565256	white, black	3000 K	800 lm	129,95 €

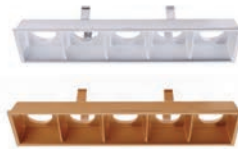

accessories

930218	reflector silver coloured	9,95 €
930215	reflector gold optics	9,95 €
862227	power supply 700 mA 2-17V 1,4-12,0 W	24,95 €
862237	power supply dimmable 700 mA 10-17V 7,0-12,0 W	26,95 €

CETI 10 ADJUST

- aluminium diecast
- dimensions L x B x H: 275 x 83 x 77 mm
- dimmable via optional power supply
- swivelling and extendable



item	colour	colour temperature	light current	price
565257	white, black	3000 K	1600 lm	219,95 €

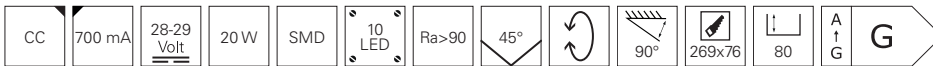

accessories

930219	reflector silver coloured	10,95 €
930216	reflector gold optics	10,95 €
862198	power supply 700 mA 13-43V 14,7-30,0 W	26,95 €
862207	power supply dimmable 700 mA 14,0-28,0V 9,8-20,0 W	39,95 €
862191	power supply MULTI-CC DALI DALI1/2/Intelli-Push dimmable 20-36V 5,0-25,0 W	64,95 €

CETI 15 ADJUST

- aluminium diecast
- dimensions L x B x H: 394 x 77 x 83 mm
- dimmable via optional power supply
- swivelling and extendable



item	colour	colour temperature	light current	price
565258	white, black	3000 K	2400 lm	289,95 €

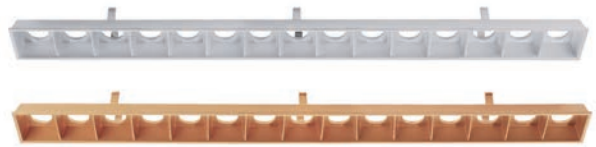
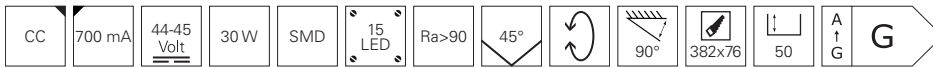

accessories

930220	reflector silver coloured	14,95 €
930217	reflector gold optics	14,95 €
862199	power supply 700 mA 20-57V 20,3-40,0 W	29,95 €
862208	power supply dimmable 700 mA 28-56V 19,6-40,0 W	46,95 €
862192	power supply MULTI-CC DALI1/2/Intelli-Push dimmable 25-64V 17,5-45,0W	69,95 €





3K SMALL
page 151



BASIC
from page 154



BASIC FLEX
from page 155



BASIC OFFICE
from page 156



PRO OFFICE
from page 157



STANDARD FLEX
from page 160



STANDARD OFFICE
from page 161



STANDARD OFFICE FLEX
from page 162



STANDARD HCL
page 164



STANDARD RGBW
page 165

insert panels





With the kind support of Regionaldirektion für Deutsche Vermögensberatung Pierre Werner / Direktion für Deutsche Vermögensberatung Uwe Liebholz



LED PANEL 3K SMALL

In the ceiling or on the ceiling – the LED PANEL 3K SMALL is convincing in every variant. In addition to the optionally available frames for the ceiling insert or the ceiling installation, the compact LED panel [available in 3000 or 4000K] can be dimmed via a separate power supply in a flexible control mode. In this way the LED PANEL 3K SMALL presents itself as a modern ceiling luminaire for offices, public authorities, restaurants and much more.



LED PANEL 3K SMALL

- aluminium
- dimensions L x B x H: 295 x 295 x 10 mm
- dimmable via optional power supply
- incl. 50 cm connection cable

item	colour	colour temperature	light current	price
565220	<input type="checkbox"/> white	 3000 K	2500 lm	75,95 €
565221	<input type="checkbox"/> white	 4000 K	2500 lm	75,95 €

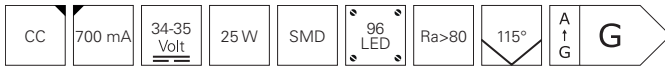

accessories

930230	insert frame 30 x 30	29,95 €
930167	surface mounting frame 30 x 30	29,95 €
862198	power supply 700 mA 21-43V 14,7-30,0 W	26,95 €
862208	power supply dimmable 700 mA 28-56V 19,6-40,0 W	46,95 €
862192	power supply MULTI-CC DALI1/2/Intelli-Push dimmable 25-64V 17,5-45,0 W	69,95 €

BACKLIGHT PANELS [SERIES: BASIC AND PRO] – TECHNOLOGY AND ADVANTAGES

Not every LED panel is built the same! There are technologies exist to produce homogeneous, flat and glare-free light. Each method has its own advantages and disadvantages and depends on the individual user requirements and budget needs. For example, the LED panels from our BASIC and PRO series rely on backlight technology.

In LED panels with backlight technology, the LEDs - behind the diffuser - are evenly spread over the entire panel surface and shine directly downwards. This design has a decisive advantage: no other components are required to direct the light in the desired direction [downwards], because the LEDs are already in the »right« position. The simpler design results above all in better efficiency and a lower price as well as a longer lifetime. At the same time you do not have to worry about possible yellowing of the light guide plate, which is often used in some cheaper sidelight panels.

The disadvantages: Due to their design, the LED elements require more space, which is why backlight panels are curved towards the backside and therefore have a higher thickness with it. For this [optical] reason, backlight panels are only suitable to a limited extent for suspension from the ceiling. Their smaller beam angle [approx. 90°] results in a smaller illuminated area.

advantages

- better efficiency
- longer lifetime
- lower costs
- much more attractive price/performance ratio
- no light guide plates that are prone to yellowing

disadvantages

- higher thickness
- lower beam angle [approx. 90°]
- less suitable for suspension
- thicker packaging

In the following picture you can see the typical structure of a backlight LED panel.





LED PANEL BASIC

- aluminium
- UGR<22
- BEG eligible [4000K]
- incl. power supply CC, 900mAh, 33-38V, 36W

item	colour	colour temperature	light current	dimensions L x B x H	price
100149	<input type="checkbox"/> white	3000 K	3880 lm	595 x 595 x 32 mm	69,95 €
100150	<input type="checkbox"/> white	4000 K	4320 lm	595 x 595 x 32 mm	69,95 €
100140	<input type="checkbox"/> white	3000 K	3900 lm	620 x 620 x 32 mm	74,95 €
100141	<input type="checkbox"/> white	4000 K	4320 lm	620 x 620 x 32 mm	74,95 €
100143	<input type="checkbox"/> white	3000 K	3880 lm	1195 x 295 x 32 mm	79,95 €
100144	<input type="checkbox"/> white	4000 K	4320 lm	1195 x 295 x 32 mm	79,95 €

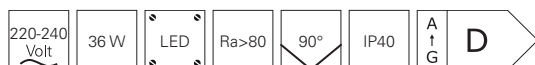

accessories

930674 safety rope **4,95 €**

930676 installation brackets **4,95 €**

optional power supplies | CC, 900mAh, 33-38V, 36W

862264 power supply dimmable | 22-44V | 19,8-40,0 W **46,95 €**

862192 power supply MULTI-CC DALI1/2/Intelli-Push dimmable | 25-64V | 17,5-45,0 W **69,95 €**

862175 power supply Meanwell KNX dimmable | 2-100V | 42,0 W **144,95 €**

862244 power supply Meanwell mit Casambi-App dimmable | 2-100V | 42,0 W **249,95 €**

accessories for **100149, 100150**

930664 surface mounting frame | 60 x 60 x 7 cm **54,95 €**

930667 mounting frame | 60 x 60 cm **52,95 €**

accessories for **100140, 100141**

930665 surface mounting frame | 62,5 x 62,5 x 7 cm **59,95 €**

930668 mounting frame | 62,5 x 62,5 cm **57,95 €**

accessories for **100143, 100144**

930666 surface mounting frame | 120 x 30 x 7 cm **69,95 €**

930669 mounting frame | 120 x 30 cm **67,95 €**



dip switch



LED PANEL BASIC FLEX

- aluminium
- UGR<22
- BEG eligible [4000K setting]
- light colour adjustable via dip switch
- incl. power supply CC, 900mAh, 33-38V, 36W

item	colour	colour temperature	light current	dimensions L x B x H	EEL	price
100142	<input type="checkbox"/> white	<input type="checkbox"/> WW <input type="checkbox"/> NW <input type="checkbox"/> CW 3000/4000/6000 K	3900/4320/4140 lm	620 x 620 x 32 mm	C	94,95 €
100145	<input type="checkbox"/> white	<input type="checkbox"/> WW <input type="checkbox"/> NW <input type="checkbox"/> CW 3000/4000/6000 K	3900/4320/4140 lm	1195 x 295 x 32 mm	D	99,95 €

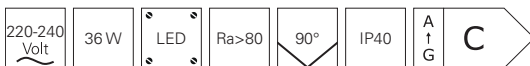

accessories

930674	safety rope	4,95 €
930676	installation brackets	4,95 €
optional power supplies CC, 900mAh, 33-38V, 36W		
862264	power supply dimmable 22-44V 19,8-40,0 W	46,95 €
862192	power supply MULTI-CC DALI1/2/Intelli-Push dimmable 25-64V 17,5-45,0 W	69,95 €
862175	power supply Meanwell KNX dimmable 2-100V 42,0 W	144,95 €
862244	power supply Meanwell mit Casambi-App dimmable 2-100V 42,0 W	249,95 €

accessories for **100142**

930665	surface mounting frame 62,5 x 62,5 x 7 cm	59,95 €
930668	mounting frame 62,5 x 62,5 cm	57,95 €

accessories for **100145**

930666	surface mounting frame 120 x 30 x 7 cm	69,95 €
930669	mounting frame 120 x 30 cm	67,95 €



LED PANEL BASIC OFFICE

- aluminium
- UGR <19
- suitable for VDU workstations according to EN 12464-1 BAP65 [L65 ≤ 3000cd/m²]
- microprismatic surface structure
- incl. power supply CC, 900mAh, 33-38V, 36W

item	colour	colour temperature	light current	dimensions L x B x H	price
100151	<input type="checkbox"/> white	<input type="checkbox"/> 4000 K	4000 lm	595 x 595 x 32 mm	79,95 €
100146	<input type="checkbox"/> white	<input type="checkbox"/> 4000 K	4000 lm	620 x 620 x 32 mm	84,95 €
100147	<input type="checkbox"/> white	<input type="checkbox"/> 4000 K	4000 lm	1195 x 295 x 32 mm	89,95 €

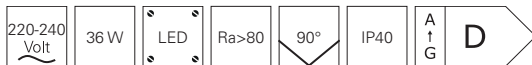

accessories

930674	safety rope	4,95 €
930676	installation brackets	4,95 €
optional power supplies CC, 900mAh, 33-38V, 36W		
862264	power supply dimmable 22-44V 19,8-40,0 W	46,95 €
862192	power supply MULTI-CC DALI1/2/Intelli-Push dimmable 25-64V 17,5-45,0 W	69,95 €
862175	power supply Meanwell KNX dimmable 2-100V 42,0 W	144,95 €
862244	power supply Meanwell mit Casambi-App dimmable 2-100V 42,0 W	249,95 €

accessories for **100151**

930664	surface mounting frame 60 x 60 x 7 cm	54,95 €
930667	mounting frame 60 x 60 cm	52,95 €

accessories for **100146**

930665	surface mounting frame 62,5 x 62,5 x 7 cm	59,95 €
930668	mounting frame 62,5 x 62,5 cm	57,95 €





accessories for **100147**

930666	surface mounting frame 120 x 30 x 7 cm	69,95 €
930669	mounting frame 120 x 30 cm	67,95 €



LED PANEL PRO OFFICE

- aluminium
- UGR <19
- suitable for VDU workstation according to EN 12464-1 BAP65 [$L65 \leq 3000\text{cd/m}^2$]
- BEG eligible
- microprismatic surface structure
- particularly energy-efficient

item	colour	colour temperature	light current	dimensions L x B x H EEL	price
100148	<input type="checkbox"/> white	 4000 K	3200 lm	595 x 595 x 32 mm C	104,95 €
100084	<input type="checkbox"/> white	 3000 K	2880 lm	620 x 620 x 32 mm E	109,95 €
100088	<input type="checkbox"/> white	 4000 K	3200 lm	620 x 620 x 32 mm E	109,95 €
100089	<input type="checkbox"/> white	 3000 K	2880 lm	1195 x 295 x 32 mm D	114,95 €
100122	<input type="checkbox"/> white	 4000 K	3200 lm	1195 x 295 x 32 mm D	114,95 €



accessories

930674	safety rope	4,95 €
930676	installation brackets	4,95 €
862257	power supply QUICK dimmable 450mAh 22-44V 9,9-20,0 W quick installation through Quick-Terminal und through-wiring	36,95 €
862191	power supply MULTI-CC DALI1/2/Intelli-Push dimmable 20-60V 5,0-25,0 W	64,95 €

accessories for **100148**

930664	surface mounting frame 60 x 60 x 7 cm	54,95 €
930667	mounting frame 60 x 60 cm	52,95 €

accessories for **100084, 100088**

930665	surface mounting frame 62,5 x 62,5 x 7 cm	59,95 €
930668	mounting frame 62,5 x 62,5 cm	57,95 €

accessories for **100089, 100122**

930666	surface mounting frame 120 x 30 x 7 cm	69,95 €
930669	mounting frame 120 x 30 cm	67,95 €

SIDELIGHT-PANELS [SERIES: STANDARD] – TECHNOLOGY AND ADVANTAGES

Not every LED panel is built the same! There are technologies exist to produce homogeneous, flat light. Each method has its own advantages and disadvantages and depends on the individual user requirements and budget needs. For example LED panels from our standard series use sidelight technology.

Unlike backlight panels, the LEDs are not spread over the entire panel surface, but are located on the side of the aluminum frame of the luminaire. Depending on the model and version, only one, two or all four sides are equipped with LED stripes. What all edgelit or sidelight panels have in common is that the LEDs shine into the center of the panel. The light must therefore still be redirected in order to radiate downwards.

The most important element here is the light guide plate. This is usually made of acrylic glass [also PMMA (poly-methyl methacrylate), a transparent thermoplastic material], which distributes the light evenly over the entire surface and deflects it downwards. In addition, acrylic glass does not yellow with age. In addition to the light guide plate, which deflects the light by means of small laser-engraved dots, the additional reflector, similar to the one the backlight panel, and the diffuser also contribute to the significantly more complex structure of a sidelight panel [see picture to the right].

The great advantage is the lower construction thickness, which is why edgelit panels can be integrated more discreetly in rooms and are better suited as pendant variants. At the same time, the panels allow a higher beam angle [approx. 120°] what results in a larger illuminated area. The disadvantages: Edgelit panels are more expensive and offer less efficiency and lifetime compared to backlight panels.

advantages

- lower thickness
- higher beam angle [approx. 120°]
- more suitable for suspension
- thinner packing

disadvantages

- higher costs
- worse price/performance ratio
- average lifetime
- lower efficiency

In the following picture you can see the typical structure of a sidelight LED panel.



aluminium frame with LEDs

microprismatic diffusing lens

diffuser disc

light guide panel

reflector insert

EVA [ethylene vinyl acetate copolymer] foam

back panel



dip switch



NEW

LED PANEL STANDARD FLEX

- aluminium
- UGR<22
- light colour adjustable via dip switch

item	colour	colour temperature	light current	dimensions L x B x H	Strom	power EEI	price
100123	<input type="checkbox"/>	white WW NW CW 3000/4000/6000 K	3780/4200/4000 lm	620 x 620 x 9 mm	1050 mA	42 W G	119,95 €
100125	<input type="checkbox"/>	white WW NW CW 3000/4000/6000 K	3570/3990/3780 lm	1195 x 295 x 9 mm	1050 mA	42 W E	124,95 €
100139	<input type="checkbox"/>	white WW NW CW 3000/4000/6000 K	5300/6000/5700 lm	1195 x 595 x 9 mm	1500 mA	60 W D	219,95 €
100154	<input type="checkbox"/>	white WW NW CW 3000/4000/6000 K	5300/6000/5700 lm	1240 x 620 x 9 mm	1500 mA	60 W D	229,95 €

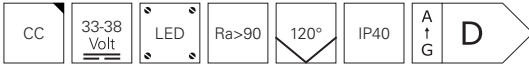

accessories

930674 safety rope **4,95 €**

accessories for 100123

930672 wire suspension | 200 cm **22,95 €**
930665 surface mounting frame | 62,5 x 62,5 x 7 cm **59,95 €**
930670 mounting frame | 62,5 x 62,5 cm **59,95 €**
862258 power supply QUICK dimmable | 1050mAh | 22-43V | 23,1-45,0 W quick installation through Quick-Terminal und through-wiring **46,95 €**
862193 power supply MULTI-CC DALI1/2/Intelli-Push dimmable | 14-43V | 14,7-45,0 W **69,95 €**

accessories for 100125

930672 wire suspension | 200 cm **22,95 €**
930666 surface mounting frame | 120 x 30 x 7 cm **69,95 €**
930671 mounting frame | 120 x 30 cm **69,95 €**
862258 power supply QUICK dimmable | 1050mAh | 22-43V | 23,1-45,0 W quick installation through Quick-Terminal und through-wiring **46,95 €**
862193 power supply MULTI-CC DALI1/2/Intelli-Push dimmable | 14-43V | 14,7-45,0 W **69,95 €**

accessories for 100139

930673 wire suspension | 200 cm **32,95 €**
930675 surface mounting frame | 120 x 60 x 7 cm **69,95 €**
930688 mounting frame | 120 x 60 cm **84,95 €**
862259 power supply QUICK dimmable | 1500mAh | 20-40V | 30,0-60,0 W quick installation through Quick-Terminal und through-wiring **56,95 €**
862194 power supply MULTI-CC DALI1/2/Intelli-Push dimmable | 25-70V | 26,3-75,0 W **84,95 €**

accessories for 100154

930673 wire suspension | 200 cm **32,95 €**
862259 power supply QUICK dimmable | 1500mAh | 20-40V | 30,0-60,0 W quick installation through Quick-Terminal und through-wiring **56,95 €**
862194 power supply MULTI-CC DALI1/2/Intelli-Push dimmable | 25-70V | 26,3-75,0 W **84,95 €**



LED PANEL STANDARD OFFICE

- aluminium
- UGR <19
- suitable for VDU workstations according to EN 12464-1 BAP65 ($L65 \leq 3000\text{cd/m}^2$)
- microprismatic surface structure

item	colour	colour temperature	light current	dimensions L x B x H	EEL	price
100124	<input type="checkbox"/> white	<input checked="" type="checkbox"/> 4000 K	4200 lm	620 x 620 x 9 mm	F	124,95 €
100138	<input type="checkbox"/> white	<input checked="" type="checkbox"/> 4000 K	4200 lm	1195 x 295 x 9 mm	E	129,95 €



accessories

930674	safety rope	4,95 €
930672	wire suspension 200 cm	22,95 €
862258	power supply QUICK dimmable 1050mAh 22-43V 23,1-45,0 W quick installation through Quick-Terminal und through-wiring	46,95 €
862193	power supply MULTI-CC DALI1/2/Intelli-Push dimmable 14-43V 14,7-45,0 W	69,95 €

accessories for **100124**

930665	surface mounting frame 62,5 x 62,5 x 7 cm	59,95 €
930670	mounting frame 62,5 x 62,5 cm	59,95 €

accessories for **100138**

930666	surface mounting frame 120 x 30 x 7 cm	69,95 €
930671	mounting frame 120 x 30 cm	69,95 €



dip switch

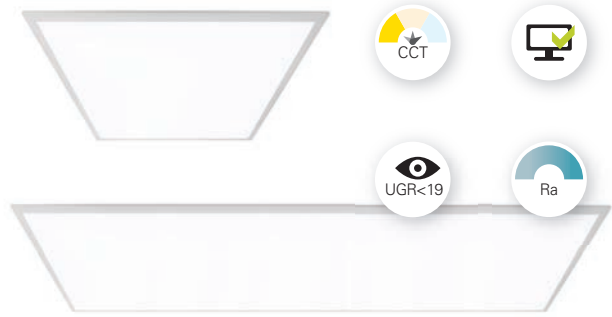

LED PANEL STANDARD OFFICE FLEX

- aluminium
- UGR < 19
- suitable for VDU workstations according to EN 12464-1 BAP65 [$L65 \leq 3000\text{cd/m}^2$]
- microprismatic surface structure
- light colour adjustable via dip switch
- incl. power supply CC, 1050mAh, 40W
- dimmable via phase control or phase cut-off

item	colour	colour temperature	light current	dimensions L x B x H	price
100078	<input type="checkbox"/> white	<input type="checkbox"/> WW <input type="checkbox"/> NW <input type="checkbox"/> CW 3000/4000/6000 K	3300 lm	620 x 620 x 10 mm	179,95 €
100079	<input type="checkbox"/> white	<input type="checkbox"/> WW <input type="checkbox"/> NW <input type="checkbox"/> CW 3000/4000/6000 K	3500 lm	1195 x 295 x 10 mm	209,95 €



accessories for **100078**

930665	surface mounting frame 62,5 x 62,5 x 7 cm	59,95 €
930670	mounting frame 62,5 x 62,5 cm	59,95 €
optional power supplies CC, 1050mAh, 40W		
862193	power supply MULTI-CC DALI1/2/Intelli-Push dimmable 14-43V 14,7-45,0 W	69,95 €
862175	power supply Meanwell KNX dimmable 2-100V 42,0 W	144,95 €
862244	power supply Meanwell mit Casambi-App dimmable 2-100V 42,0 W	249,95 €

accessories for **100079**

930666	surface mounting frame 120 x 30 x 7 cm	69,95 €
930671	mounting frame 120 x 30 cm	69,95 €
optional power supplies CC, 1050mAh, 40W		
862193	power supply MULTI-CC DALI1/2/Intelli-Push dimmable 14-43V 14,7-45,0 W	69,95 €
862175	power supply Meanwell KNX dimmable 2-100V 42,0 W	144,95 €
862244	power supply Meanwell mit Casambi-App dimmable 2-100V 42,0 W	249,95 €





LED PANEL STANDARD HCL

- aluminium
- dimensions L x B x H: 620 x 620 x 10 mm
- dimmable via optional controller

item	colour	colour temperature	light current	price
100032	<input type="checkbox"/> white	<input checked="" type="checkbox"/> ww <input checked="" type="checkbox"/> cw 3000-5500 K	3551 lm	149,75 €



accessories

930665	surface mounting frame 62,5 x 62,5 x 7 cm	59,95 €
930670	mounting frame 62,5 x 62,5 cm	59,95 €
862122	power supply 24V DC 50 W	52,95 €
862166	power supply 24V DC 100 W	96,95 €
843501	RF-smart controller starter set CCT 12/24/48V	99,95 €
843051	DALI DT6 PWM dimmer 2 channel / 12/24V	109,95 €
843071	DALI DT8 PWM dimmer 2 channel / 12/24V	109,95 €

additional controller and dimmer from page 762

additional power supplies from page 729



LED PANEL STANDARD RGBW

- aluminium
- particularly powerful and intense colours
- dimmable via optional controller

item	colour	colour temperature	light current	dimensions L x W x H	power RGB	power W	price
100152	<input type="checkbox"/> white	RGB + 3000 K	4000 lm	620 x 620 x 11 mm	3x 18W	40W	189,95 €
100153	<input type="checkbox"/> white	RGB + 4000 K	4200 lm	620 x 620 x 11 mm	3x 18W	40W	189,95 €
100156	<input type="checkbox"/> white	RGB + 3000 K	4000 lm	595 x 595 x 11 mm	3x 18W	40W	184,95 € NEW
100157	<input type="checkbox"/> white	RGB + 4000 K	4200 lm	595 x 595 x 11 mm	3x 18W	40W	184,95 € NEW

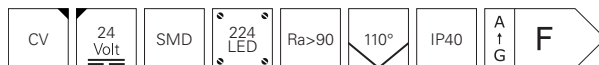

accessories

862166	power supply 24V DC 100 W IP20	96,95 €
872091	power supply 24V DC 320 W IP67	219,95 €
843502	RF-smart controller starter set RGBW 12/24/48V	99,95 €
843037	Casambi Bluetooth dimmer 4 Channel 12/24V	179,95 €
843010	DALI DT6 DMX PWM dimmer 4 channel 12/24/48V 12/24V	129,95 €
843070	DALI1/2 DT6 dimmer 4 channel 12/24/48V	134,95 €
843279	DMX PWM dimmer 4 channel 12/24/48V	114,95 €

accessories for **100152/100153**

930665	surface mounting frame 62,5 x 62,5 x 7 cm	59,95 €
930668	mounting frame 62,5 x 62,5 cm	57,95 €

accessories for **100156/100157**

930664	surface mounting frame 60 x 60 x 7 cm	54,95 €
930667	mounting frame 60 x 60 cm	52,95 €

additional controller and dimmer from page 762
 additional power supplies from page 729



□ ■
page 168



□ ■
page 170



□ □ ■
page 172



□ □ ■
page 172



□ □
page 174



□ □
page 176



□ □
page 177



■ □ □
page 178



■ ■ ■
page 180



□ □ ■
■ ■
page 180



□
page 182

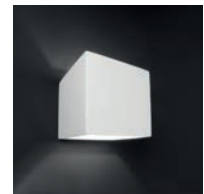

□
page 182



□
page 182



□
page 183



□
page 183



■
page 184

surface mounted wall lights





ASTEROPE LINEAR

Light & shadow: Hardly any luminaire embodies this dualism more beautifully than the ASTEROPE in its various versions. The wall luminaire, which is open at the top and bottom, creates a multifaceted play of light and shadow on walls and ceilings that blends extravagantly yet harmoniously into any ambience.



suitable
pendant lights
page 25
342135
342136

ASTEROPE LINEAR

- metal
- dimensions L x W: 300 x 150 mm
- dimmable via optional illuminants

item	colour	price
341216	white	79,95 €
341217	black	79,95 €



suitable illuminants on page 802



suitable
table and
floor lights
page 204
346003
346004
343020
343021





suitable recessed ceiling lights
from page 138
565343
565361



suitable surface-mounted ceiling luminaires
from page 72
348124
348179
348125
348175
348107
348210

UNI II

- aluminium diecast
- dimensions L x W x H x Ø: 120 x 95 x 205 x 100 mm
- socket L x W x H: 120 x 43 x 205 mm
- dimmable via phase control or phase cut-off

item	colour	colour temperature	light current	price
341215	□ white	www 3000 K	670 lm	179,95 €
341232	■ black	www 3000 K	670 lm	179,95 €



suitable power luminaire
page 352
707044
707131



accessories



930339	reflector ring black	10,95 €
930340	reflector ring gold	10,95 €
930341	reflector ring chrome	10,95 €
930371	reflector ring II black glossy	10,95 €
930334	cover backside white	3,55 €
930335	cover backside black	2,95 €
930336	cover heatsink white	3,55 €
930337	cover heatsink black	7,95 €
930306	reflector 50°	8,95 €
930307	honeycomb filter	8,95 €
930308	spread lens 40° clear/satined	8,95 €
930309	softening lens 47° satined	8,95 €
930310	linear spread lens 40°/80° asymmetric clear/satined	8,95 €

ARIETIS

A modern wall lamp with outstanding design and glare-free light. The ARIETIS impresses with its clear line, the beautiful and very elegant finish in polished aluminium and convinces completely with the built-in G9 socket. This gives you the possibility to choose the right illuminant for you. Whether halogen or LED, warm white or cool white, you have the strings in your hand. Hardly any other luminaire emphasises your modern lifestyle like the ARIETIS.

ARIETIS

- aluminium diecast
- dimensions L x W x H: 170 x 85 x 70 mm
- socket L x W x H: 120 x 45 x 20 mm
- dimmable via optional illuminants

item	colour	price
341188	 white	89,95 €
341189	 silver coloured	89,95 €
341190	 black	89,95 €



suitable illuminants on page 800









ACAMAR

Small, noble, elegant and unobtrusive – the ACAMAR is a luminaire made of high-quality aluminium. The colour rendering value is over 90, which means high colour fastness. The design is chic and interesting due to the single-sided rounding. You can mount the luminaire with the rounding upwards or downwards, depending on your preference. The white lacquering on the inside emphasises the warm white light and distributes it pleasantly upwards and downwards. The outside is highly polished and thus shines in full brilliance.

ACAMAR

- aluminium diecast
- dimensions L x W x H: 170 x 100 x 80 mm
- socket L x W x H: 120 x 60 x 33 mm
- dimmable via phase control or phase cut-off

item	colour	colour temperature	light current	price
341194	 white	 3000 K	390 lm	149,95 €
341195	 silver coloured	 3000 K	400 lm	139,95 €
341196	 black	 3000 K	250 lm	139,95 €

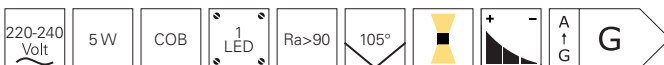

With the kind support of Regionaldirektion für Deutsche Vermögensberatung Pierre Werner / Direktion für Deutsche Vermögensberatung Uwe Liebholz



CANOPUS

Our light chameleon: extraordinary design meets innovative dimmer technology. The further you dim the CANOPUS, the warmer the light becomes. No luminaire comes close to real candlelight - but the CANOPUS is not far off. Elegant, glare-free and modern ambient lighting at its best!



CANOPUS

- aluminium diecast
- dimensions L x W x H: 140 x 115 x 265 mm
- socket L x W x H: 110 x 110 x 33 mm
- dim to warm

item	colour	colour temperature	light current	price
341197	<input type="checkbox"/> white	2000-3000 K	900 lm	219,95 €
341198	<input type="checkbox"/> silver coloured	2000-3000 K	900 lm	219,95 €







PARALA & LARGA

The simple PARALA and LARGA wall-mounted luminaires impress with their linear design and high-quality aluminium housing, which is available in two different finishes. However, they not only set the stage with their modern housing shape, but also create a pleasant lighting atmosphere with their indirect warm white light source.



PARALA 425

- aluminium diecast
- dimensions L x W x H: 425 x 44 x 34 mm
- socket L x W x H: 170 x 44 x 34 mm



item	colour	colour temperature	light current	price
341208	<input type="checkbox"/> white satined	3000 K	440 lm	114,95 €
341207	<input type="checkbox"/> silver coloured brushed	3000 K	440 lm	114,95 €





LARGA 910

- aluminium diecast
- dimensions L x W x H: 910 x 44 x 44 mm
- socket L x W x H: 170 x 44 x 37 mm

item	colour	colour temperature	light current	price
341210	<input type="checkbox"/> white satined	 3000 K	770 lm	214,95 €
341209	<input type="checkbox"/> silver coloured brushed	 3000 K	770 lm	214,95 €



APODIS

Luminaire or piece of jewellery? We are happy to leave the decision to you. However, the APODIS in its two lengths and surface finishes in gold and rose gold is a timeless and flexible lighting element that decorates every wall with its dimmable, two-sided LED light emission.



APODIS 500

- aluminium
- dimensions L x W x H: 76 x 61 x 500 mm
- socket L x W x H: 60 x 18 x 100 mm
- dimmable via phase control or phase cut-off

item	colour	colour temperature	light current	price
341200	gold optics	ww 3000 K	350 lm	209,95 €
341201	rosé	ww 3000 K	350 lm	199,95 €



APODIS 800

- aluminium
- dimensions L x W x H: 76 x 61 x 800 mm
- socket L x W x H: 60 x 18 x 100 mm
- dimmable via phase control or phase cut-off

item	colour	colour temperature	light current	price
341202	gold optics	ww 3000 K	450 lm	249,95 €
341203	rosé	ww 3000 K	450 lm	249,95 €

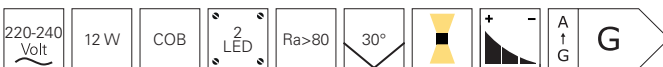





CUBE

- concrete
- dimensions L x W x H: 115 x 115 x 115 mm
- dimmable via optional illuminants

item	colour	price
341183	grey	69,95 €
341184	dark grey	69,95 €
341185	beige	69,95 €



suitable illuminants on page 800



MINI CUBE

- aluminium
- dimensions L x W x H: 80 x 80 x 65 mm
- socket Ø: 100 mm

item	colour	colour temperature	light current	price
620137	gypsum white	3000 K	350 lm	74,95 €
620136	concrete grey	3000 K	350 lm	74,95 €
620139	concrete grey granite	3000 K	350 lm	74,95 €
620138	concrete beige granite	3000 K	350 lm	74,95 €
620140	concrete black	3000 K	350 lm	74,95 €

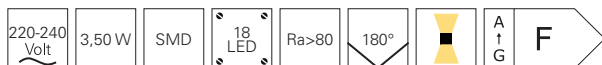



GIORGIA

- gypsum
- dimensions L x W x H: 70 x 100 x 120 mm
- socket L x W: 90 x 45 mm
- dimmable via optional illuminants

item	colour	price
341033	<input type="checkbox"/> white paintable	49,95 €



suitable illuminants on page 800

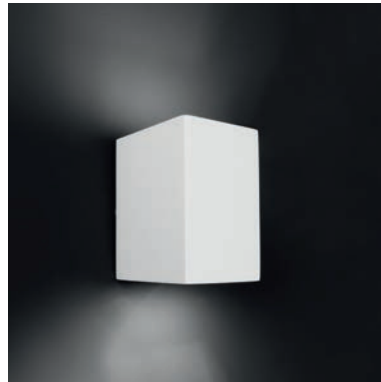

OLGA

- gypsum
- dimensions L x W x H: 142 x 142 x 140 mm
- socket L x W x H: 120 x 120 x 17 mm
- dimmable via optional illuminants

item	colour	price
341225	<input type="checkbox"/> white paintable	49,95 €



suitable illuminants on page 800



ESSA

- gypsum
- dimensions L x W x H: 255 x 75 x 100 mm
- socket L x W: 88 x 58 mm
- dimmable via optional illuminants

item	colour	price
341105	<input type="checkbox"/> white paintable	64,95 €



suitable illuminants on page 800-801

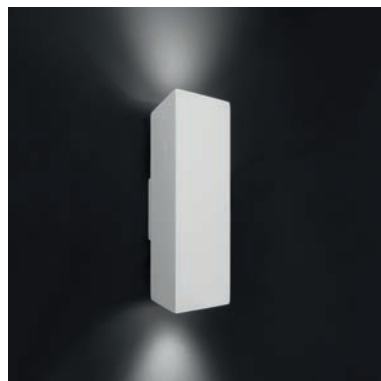

ARIANNA

- gypsum
- dimensions L x W x H: 300 x 95 x 140 mm
- socket L x W: 155 x 20 mm
- dimmable via optional illuminants

item	colour	price
341035	<input type="checkbox"/> white paintable	69,95 €

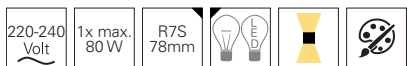

suitable illuminants on page 806



CAROLINE

- gypsum
- dimensions L x W x H: 377 x 177 x 121 mm
- socket L x W x H: 215 x 62 x 20 mm
- dimmable via optional illuminants

item	colour	price
341223	<input type="checkbox"/> white paintable	99,95 €



suitable illuminants on page 803-805



CREATIVE IDEAS FOR YOUR PLASTER LUMINAIRES

Plaster luminaires are very easy to design individually. After priming [e.g. with deep primer], you can paint, spray, varnish or even glue on the plaster surface. Experienced designers carefully remove or apply material and thus create a real one-of-a-kind luminaire.

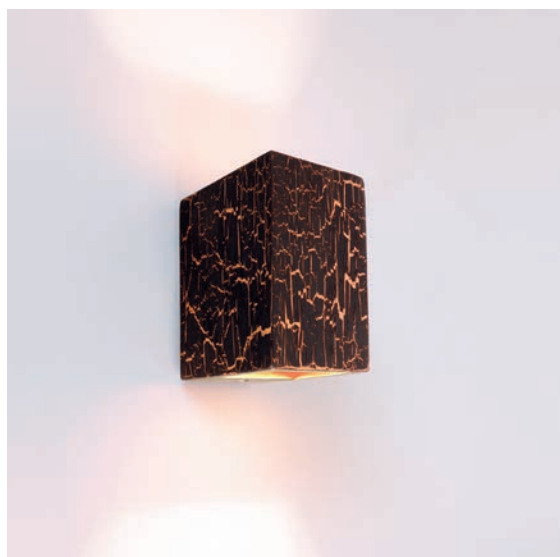

MADERA

The MADERA series is made of first-class European oak wood and impresses with its modern design and mix of materials in private living areas, hotels, restaurants and many more. The noble MADERA luminaires distribute their powerful warm white light in any room and thus also cut an excellent figure as functional and high-quality lighting at reception counters and more.



suitable
ceiling lights
page 91
348147



suitable
pendant lights
page 52
342234
342235
342236

MADERA

- modern, exclusive design
- from high-quality oiled oak wood of grade A
- FSC-certified raw material oak wood from sustainable forests
- environmentally friendly packaging
- oak wood | iron
- dimensions L x W x H: 450 x 60 x 130 mm
- socket L x W x H: 250 x 60 x 30 mm

item	colour	colour temperature	light current	price
341248	brown, black	3000 K	560 lm	279,95 €



suitable
table /
floor lights
page 206
346044
343031





□
page 188



□ □ ■
page 188



□ □ ■
page 188



□ □ ■
page 188



□ □ ■
page 188



□
page 189



□ □ ■
page 189



□ □ ■
page 189



□ □ ■
page 189



□ □ ■
page 189

built in wall lights



ALWAID 2

ALWAID is your problem solver when space is tight. Thanks to its small design, the recessed wall luminaire fits into all 68 mm deep switch boxes and does not require a power supply unit.

With its numerous covers, it blends safely into its surroundings and presents a beautiful indirect light that can be dimmed.

ALWAID 2

- aluminium diecast
- dimensions H x Ø: 40 x 71 mm
- dimmable via phase control or phase cut-off
- suitable for 68 mm switch boxes in deep version

item	colour	colour temperature	light current	price
563009	<input type="checkbox"/> white	2700 K	230 lm	79,95 €

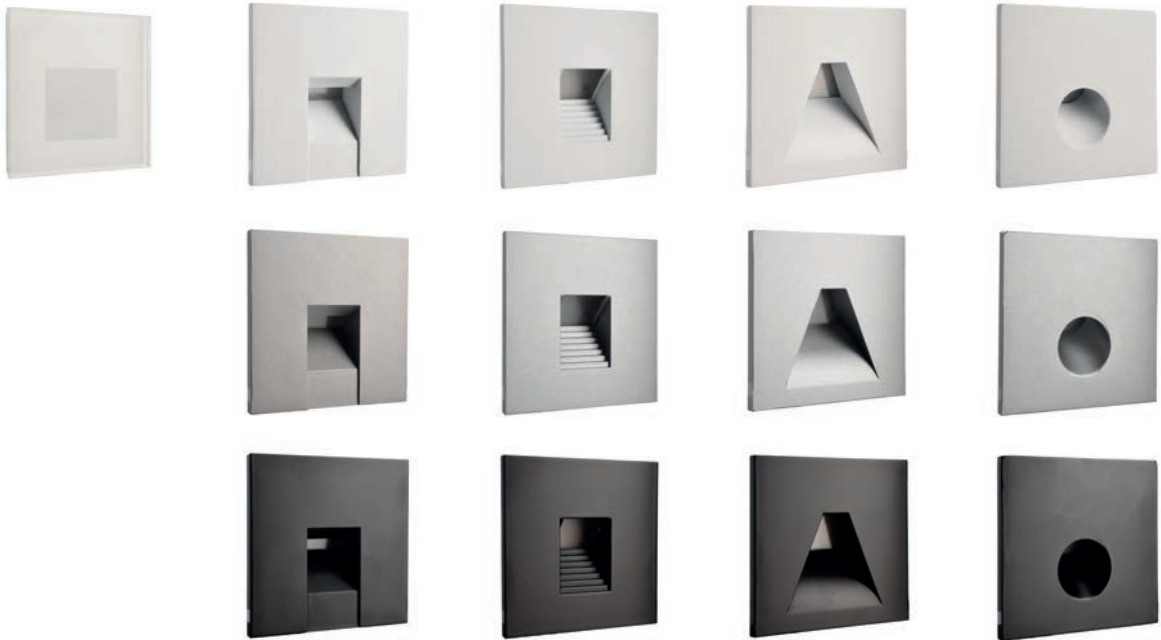
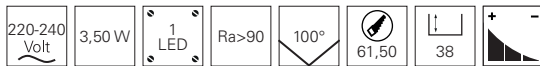

cover

930480	<input type="checkbox"/> angular milky white L x W x H: 78 x 78 x 22 mm	19,95 €
930482	<input type="checkbox"/> angular square white L x W x H: 75 x 75 x 22 mm	14,95 €
930485	<input type="checkbox"/> angular step white L x W x H: 75 x 75 x 22 mm	14,95 €
930488	<input type="checkbox"/> angular trapeze white L x W x H: 75 x 75 x 22 mm	14,95 €
930491	<input type="checkbox"/> angular round white L x W x H: 75 x 75 x 22 mm	14,95 €
930483	<input type="checkbox"/> angular square aluminium L x W x H: 75 x 75 x 22 mm	14,95 €
930486	<input type="checkbox"/> angular step aluminium L x W x H: 75 x 75 x 22 mm	14,95 €
930489	<input type="checkbox"/> angular trapeze aluminium L x W x H: 75 x 75 x 22 mm	14,95 €
930492	<input type="checkbox"/> angular round aluminium L x W x H: 75 x 75 x 22 mm	14,95 €
930484	<input checked="" type="checkbox"/> angular square black L x W x H: 75 x 75 x 22 mm	14,95 €
930487	<input checked="" type="checkbox"/> angular step black L x W x H: 75 x 75 x 22 mm	14,95 €
930490	<input checked="" type="checkbox"/> angular trapeze black L x W x H: 75 x 75 x 22 mm	14,95 €
930493	<input checked="" type="checkbox"/> angular round black L x W x H: 75 x 75 x 22 mm	14,95 €

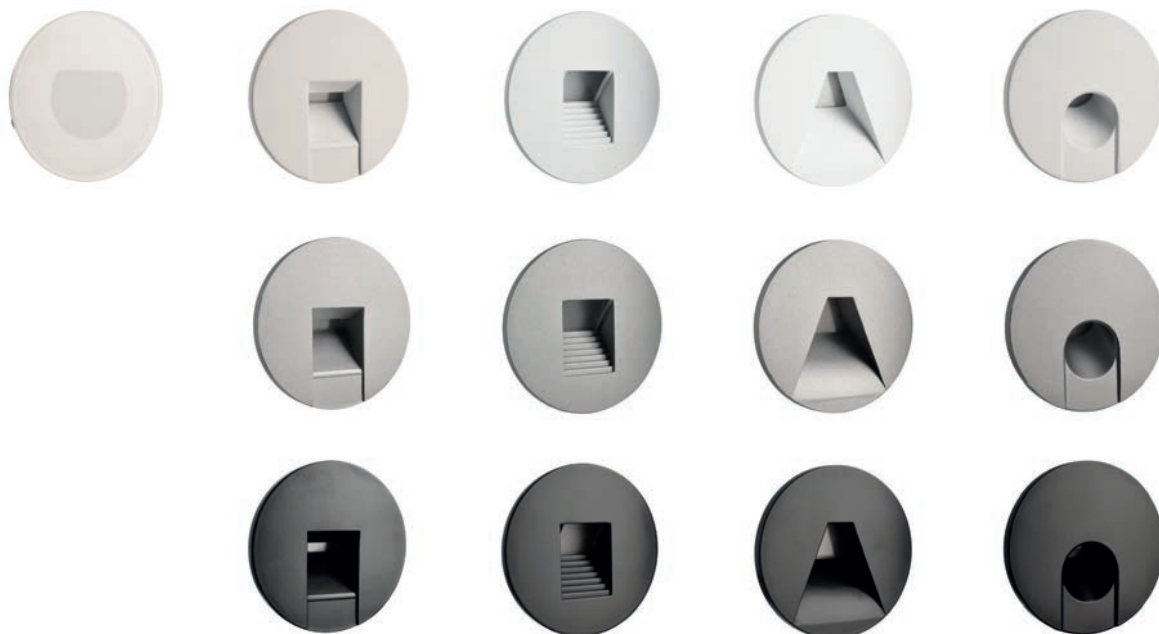

cover

930481	□ round milky white H x Ø: 22 x 78 mm	19,95 €
930500	□ round square white H x Ø: 22 x 78 mm	14,95 €
930497	□ round step white H x Ø: 22 x 78 mm	14,95 €
930503	□ round trapeze white H x Ø: 22 x 78 mm	14,95 €
930494	□ round round white H x Ø: 22 x 78 mm	14,95 €
930501	□ round square aluminium H x Ø: 22 x 78 mm	14,95 €
930498	□ round step aluminium H x Ø: 22 x 78 mm	14,95 €
930504	□ round trapeze aluminium H x Ø: 22 x 78 mm	14,95 €
930495	□ round round aluminium H x Ø: 22 x 78 mm	14,95 €
930502	■ round square black H x Ø: 22 x 78 mm	14,95 €
930499	■ round step black H x Ø: 22 x 78 mm	14,95 €
930505	■ round trapeze black H x Ø: 22 x 78 mm	14,95 €
930496	■ round round black H x Ø: 22 x 78 mm	14,95 €



page 193



page 193



page 195

reading lights





BRAHE IV

Whether as a wall lamp next to the bed, as a bedside lamp or as a floor lamp behind the reading chair – when you put the book or newspaper away, conventional reading lights often lack indirect lighting options. Here the BRAHE comes into play with its illuminated socket, which can be switched separately and creates atmospheric, indirect islands of light that provide the right light even after reading.



BRAHE I

- modern design
- individually adjustable via flexible arm and thus optimal as a reading light
- aluminium
- dimensions L x H x Ø: 310 x 80 x 25 mm
- socket L x W x H: 80 x 80 x 25 mm

item	colour	colour temperature	light current	price
341236	□ white	ww 3000 K	175 lm	64,95 €
341237	■ black	ww 3000 K	165 lm	64,95 €



suitable
table and
floor lights
page 198
346015
346016
343025
343026



BRAHE IV

- modern design
- direct and indirect lighting can be switched separately
- impresses with simplicity and elegance
- aluminium
- dimensions B x Ø: 110 x 150 mm
- primary light: 2,00 W / 1 LED
- ambient light: 4,80 W / 48 LED

item	colour	colour temperature	light current	price
341242	□ white	ww 3000 K	490 lm	99,99 €
341243	■ black	ww 3000 K	395 lm	99,99 €

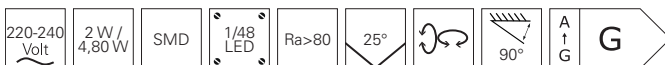

suitable
table and
floor lights
page 198
346015
346016
343025
343026



ALWA

The ALWA combines two luminaires in one sophisticated design: a bedside luminaire with indirect shade lighting and a reading spot. The highlight is the rotatable and swivelling arm [tilt angle: 90°], which enables the ALWA to provide targeted illumination. With its narrow beam angle of 20°, the ALWA also ensures that the person next to the bed is guaranteed not to be disturbed. We wish you a pleasant night's sleep.



ALWA I

- modern design
- flexible application possibilities due to rotatable luminaire body
- ideal as bed and reading lamp
- aluminium
- dimensions L x Ø: 110 x 30 mm
- socket L x W x H: 135 x 50 x 28 mm

item	colour	colour temperature	light current	price
341228	□ white	ww 3000 K	200 lm	114,95 €
341229	■ black	ww 3000 K	180 lm	114,95 €

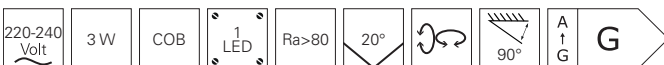



□ ■
page 198



□ ■
page 198



□ ■ ■
page 200



□ ■ ■
page 202



□ ■
page 204



□ ■
page 204



■
page 206



■
page 206

table and floor lights





BRAHE

- modern design
- direct and indirect lighting can be switched separately
- impresses with simplicity and elegance
- aluminium
- dimensions L x Ø: 455 x 150 mm
- primary light: 2,00 W / 1x LED
- ambient light: 4,80 W / 48x LED

item	colour	colour temperature	light current	price
346015	white	3000 K	470 lm	139,95 €
346016	black	3000 K	370 lm	139,95 €



suitable
reading lights
page 193
341242
341243
341236
341237



BRAHE

- modern design
- direct and indirect lighting can be switched separately
- impresses with simplicity and elegance
- aluminium
- dimensions L x Ø: 1387 x 305 mm
- primary light: 3,00 W / 1x LED
- ambient light: 8,00 W / 72x LED

item	colour	colour temperature	light current	price
343025	white	3000 K	530 lm	219,95 €
343026	black	3000 K	530 lm	219,95 €

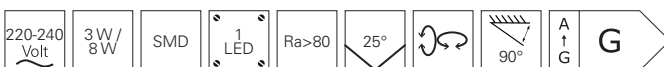

suitable
reading lights
page 193
341242
341243
341236
341237







ADHARA

- practical design
- double adjustable and fixable via joints
- 3-level dimmable via touch sensor
- aluminium
- dimensions L x Ø: 335 x 150 mm
- socket H x Ø: 16 x 160 mm / 22 x 180 mm

item	colour	colour temperature	light current	price
346030	<input type="checkbox"/> white	3000 K	950 lm	119,95 €
346031	<input type="checkbox"/> silver coloured	3000 K	950 lm	119,95 €
346029	<input type="checkbox"/> black	3000 K	950 lm	119,95 €





ADHARA

Classic design interpreted in a modern way – the ADHARA made of aluminium impresses with its classic lines, state-of-the-art materials and high flexibility. Thanks to the three joints, ADHARA can be optimally adjusted to any situation. Its powerful LED module delivers 640/800 lumens and can also be dimmed thanks to the touch sensor. Whether in an executive's office or at a child's desk, ADHARA cuts a fine figure everywhere.



ADHARA

- practical design
- double adjustable and fixable via joints
- 3-level dimmable via touch sensor
- aluminium
- dimensions L x Ø: 480 x 150 mm
- socket H x Ø: 16 x 160 mm / 22 x 180 mm

item	colour	colour temperature	light current	price
346027	<input type="checkbox"/> white	3000 K	950 lm	179,95 €
346028	<input type="checkbox"/> silver coloured	3000 K	950 lm	179,95 €
346026	<input type="checkbox"/> black	3000 K	950 lm	179,95 €



ASTEROPE

Light & shadow: Hardly any luminaire embodies this dualism more beautifully than ASTEROPE. The table and floor lamps create a multifaceted play of light and shadow on walls and ceilings that blends extravagantly yet harmoniously into any ambience.

ASTEROPE LINEAR

- metal
- dimensions H x Ø: 450 x 150 mm
- socket H x Ø: 25 x 150 mm
- incl. 2 m connection cable with switch

item	colour	price
346003	<input type="checkbox"/> white	119,95 €
346004	<input checked="" type="checkbox"/> black	119,95 €



suitable illuminants on page 803-805



suitable
pendant lights
page 25
342135
342136



suitable
wall lights
page 170
341216
341217

ASTEROPE LINEAR

- metal
- dimensions H x Ø: 1600 x 210 mm
- socket H x Ø: 30 x 250 mm
- incl. 2,30 m connection cable with switch

item	colour	price
343020	<input type="checkbox"/> white	199,95 €
343021	<input checked="" type="checkbox"/> black	199,95 €



suitable illuminants on page 803-805



suitable
pendant lights
page 25
342135
342136



suitable
wall lights
page 170
341216
341217



MADERA

The MADERA series is made of first-class European oak wood and impresses with its modern design and mix of materials in private living areas, hotels, restaurants and many more. The noble MADERA luminaires distribute their powerful warm white light in any room and thus also cut an excellent figure as functional and high-quality lighting at reception counters and more.

MADERA

- modern, exclusive design
- manufactured in Europe from high-quality oiled oak wood of grade A
- FSC-certified raw material oak wood from sustainable forestry
- environmentally friendly packaging
- infinitely dimmable via touch sensor
- oak wood | iron
- dimensions L x W x H: 40 x 60 x 510 mm
- socket L x W x H: 160 x 130 x 6 mm

item	colour	colour temperature	light current	price
346044	 brown, black	 3000 K	420 lm	299,95 €

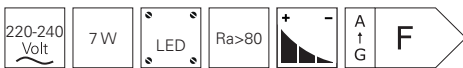

suitable
ceiling light
page 91
348147



suitable
pendant lights
page 52
342234
342235
342236



suitable
wall light
page 184
341248



MADERA

- modern, exclusive design
- manufactured in Europe from high-quality oiled oak wood of grade A
- FSC-certified raw material oak wood from sustainable forestry
- environmentally friendly packaging
- infinitely dimmable via touch sensor
- oak wood | iron
- dimensions L x W x H: 40 x 60 x 1410 mm
- socket L x W x H: 250 x 180 x 6 mm

item	colour	colour temperature	light current	price
343031	 brown, black	 3000 K	1610 lm	549,95 €

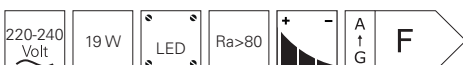

suitable
ceiling light
page 91
348147



suitable
pendant lights
page 52
342234
342235
342236



suitable
wall light
page 184
341248





page 210





page 211



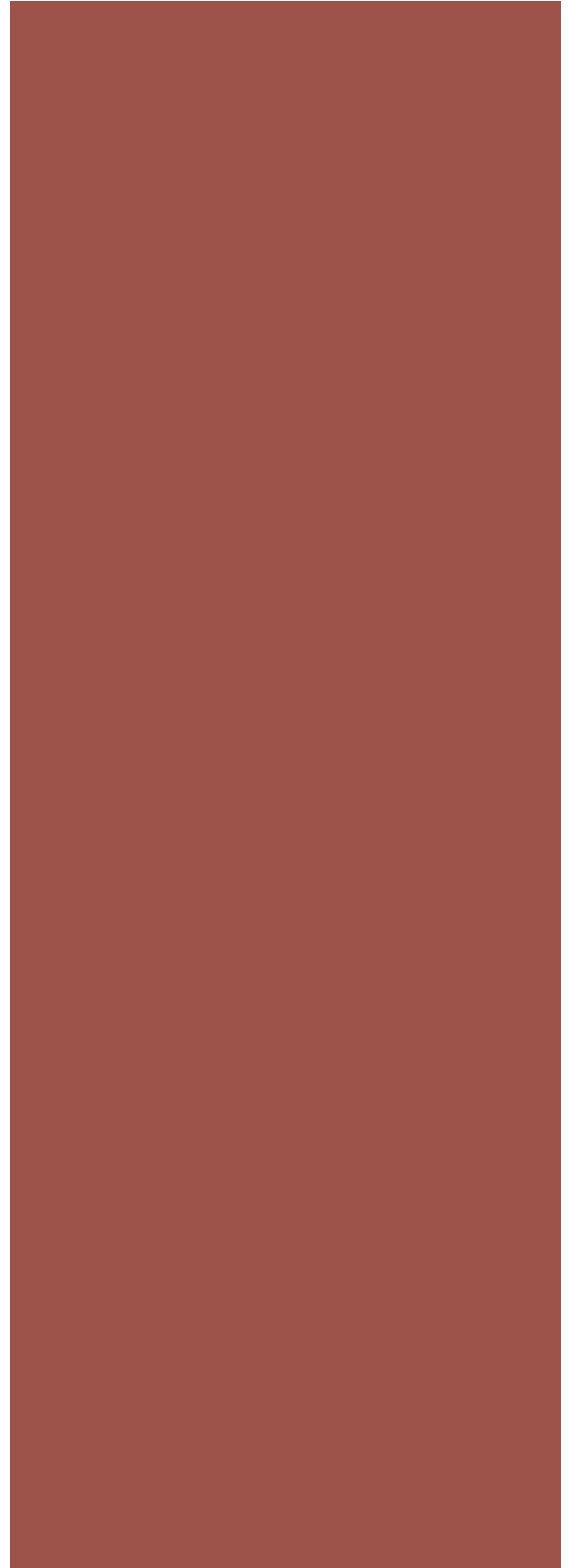

from page 212

furniture lights

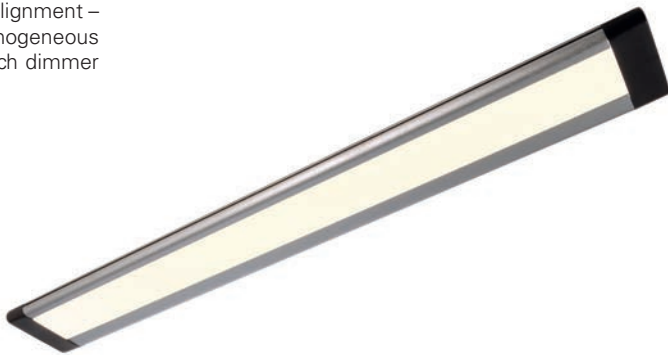

MIA

With their wide range of accessories, the versatile furniture luminaires of the MIA series offer the right solution for every situation. Whether in horizontal or vertical alignment – MIA convinces with its high light output and homogeneous illumination. It is conveniently controlled via touch dimmer or via a configurable PIR motion sensor.



MIA

- aluminium
- dimensions B x H: 38 x 8 mm
- dimmable via optional accessories

item	colour	colour temperature	light current	dimensions L	power	price
687062	silver coloured / black	3000 K	210 lm	300 mm	5 W	45,95 €
687064	silver coloured / black	4000 K	250 lm	300 mm	5 W	45,95 €
687070	silver coloured / black	3000 K	330 lm	500 mm	8 W	65,95 €
687071	silver coloured / black	4000 K	350 lm	500 mm	8 W	65,95 €
687072	silver coloured / black	3000 K	800 lm	1000 mm	14 W	119,95 €
687073	silver coloured / black	4000 K	620 lm	1000 mm	14 W	119,95 €

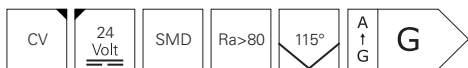

accessories

930212	touch dimmer black	13,95 €
930213	IR sensor black	22,95 €
930160	connector linear black	2,25 €
930191	angle connector flat black	3,25 €
930209	angle connector vertical black	3,95 €
687117	connection cable black 150 mm	1,95 €
687118	connection cable black 250 mm	1,95 €
930243	connection cable black 1000 mm	3,25 €
930242	mounting clips adjustable set of 2 plastic transparent	4,25 €
930214	mounting clips set of 5 metal silver coloured	1,10 €
862037	power plug unit 24V DC 6 W 1,5 m cable	15,95 €
862038	power plug unit 24V DC 24 W 1,5 m cable	29,95 €
862074	power plug unit 24V DC 36 W 1,5 m cable	39,95 €

MIA

- aluminium
- dimensions B x H: 38 x 8 mm
- dimmable via optional accessories



item	colour	colour temperature	light current	dimensions L	power	price
687074	<input type="checkbox"/> white	WW 3000 K	210 lm	300 mm	5 W	45,95 €
687075	<input type="checkbox"/> white	NW 4000 K	250 lm	300 mm	5 W	45,95 €
687076	<input type="checkbox"/> white	WW 3000 K	330 lm	500 mm	8 W	66,95 €
687077	<input type="checkbox"/> white	NW 4000 K	350 lm	500 mm	8 W	66,95 €
687078	<input type="checkbox"/> white	WW 3000 K	800 lm	1000 mm	14 W	119,95 €
687079	<input type="checkbox"/> white	NW 4000 K	620 lm	1000 mm	14 W	109,95 €

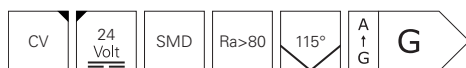

accessories

930250	touch dimmer white	11,95 €
930251	IR sensor white	24,95 €
930247	connector linear white	2,25 €
930248	angle connector flat white	3,25 €
930249	angle connector vertical white	4,55 €
930244	connection cable white 150 mm	1,75 €
930245	connection cable white 250 mm	1,75 €
930566	connection cable white 1000 mm	3,16 €
930242	mounting clips adjustable set of 2 plastic transparent	4,25 €
930214	mounting clips set of 5 metal silver coloured	1,10 €
862037	power plug unit 24V DC 6 W 1,5 m cable	15,95 €
862038	power plug unit 24V DC 24 W 1,5 m cable	29,95 €
862074	power plug unit 24V DC 36 W 1,5 m cable	39,95 €



BAHAM I

- aluminium
- dimensions H x Ø: 12,50 x 62 mm
- dimmable via optional power supply

item	colour	colour temperature	light current	price
687096	 silver coloured brushed	 3000 K	240 lm	34,95 €



accessories

872127	power supply 12V DC 4,0 W	12,95 €
862232	power supply 12V DC 20,0 W	25,95 €
862240	power supply dimmable 12V DC 2,5 - 25,0 W	54,95 €

SIMPLE, FAST, SAFE & POWERFUL

With our pre-assembled and ready-to-connect bundles, you are optimally prepared for current and future challenges in LED technology. In particular, carpenters as well as exhibition stand and shop fitters will find the right products for their ever-growing catalogue of requirements.

We are your partner when it comes to ready-to-plug-in solutions with high lumen packages. With our powerful bundles in numerous versions and configurations, customer requirements can be implemented quickly, efficiently and reliably.



BAHAM I BUNDLE OF 3

- 3 x surface-mounted/built-in furniture luminaire BAHAM I 687099
- dimensions H x Ø: 12,5 x 62 mm
- 1 x DEKO-LIGHT power supply dimmable 862169
- dimmable via phase control or phase cut-off
- incl. 6-fold AMP distributor [extension up to 6 luminaires]

item	colour	colour temperature	light current	price
620006	 silver coloured brushed	 3000 K	3x 240 lm	139,95 €

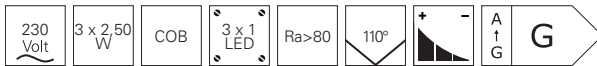

suitable pre-assembled accessories for extending the cabling on page 815



BAHAM I BUNDLE OF 5

- 5 x surface-mounted/built-in furniture luminaire BAHAM I 687099
- dimensions H x Ø: 12,5 x 62 mm
- 1 x DEKO-LIGHT power supply 862169
- dimmable via phase control or phase cut-off
- incl. 6-fold AMP distributor [extension up to 6 luminaires]

item	colour	colour temperature	light current	price
620007	 silver coloured brushed	 3000 K	5x 240 lm	199,95 €

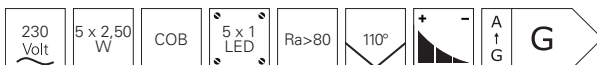

suitable pre-assembled accessories for extending the cabling on page 815



page 217



page 218



page 218



page 220



page 220

showcase lights



HERCULIS

Small helpers, big effect. With HERCULIS display luminaires in high-quality aluminium housings, you can reach all corners of a showcase. The luminaire head with its 40° beam angle can be freely rotated and swivelled in any direction. In addition, the intelligent cable routing and the ready-to-plugin system allow easy surface and recessed mounting in showcases, counters, sales areas or in the living room.

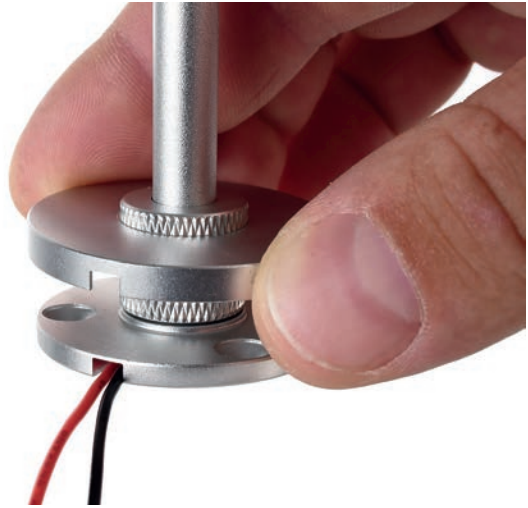



HERCULIS MAGNETIC

- design optimised for cabinets and showcases
- high performance despite compact design
- ready-to-plug-in system
- rotatable and swivelling head
- flexible mounting thanks to magnets
- aluminium diecast
- dimensions L x Ø: 42 x 31 mm
- socket H x Ø: 5 x 31 mm



item	colour	colour temperature	light current	price
688026	silver coloured	3000 K	100 lm	57,95 €
688025	black	3000 K	100 lm	57,95 €
688028	silver coloured	4000 K	105 lm	57,95 €
688027	black	4000 K	105 lm	57,95 €



accessories

930594	power supply 12W, ready to plug in incl. 3-way distributor	32,95 €
930592	power supply 20W, ready to plug in incl. 6-way distributor	39,95 €

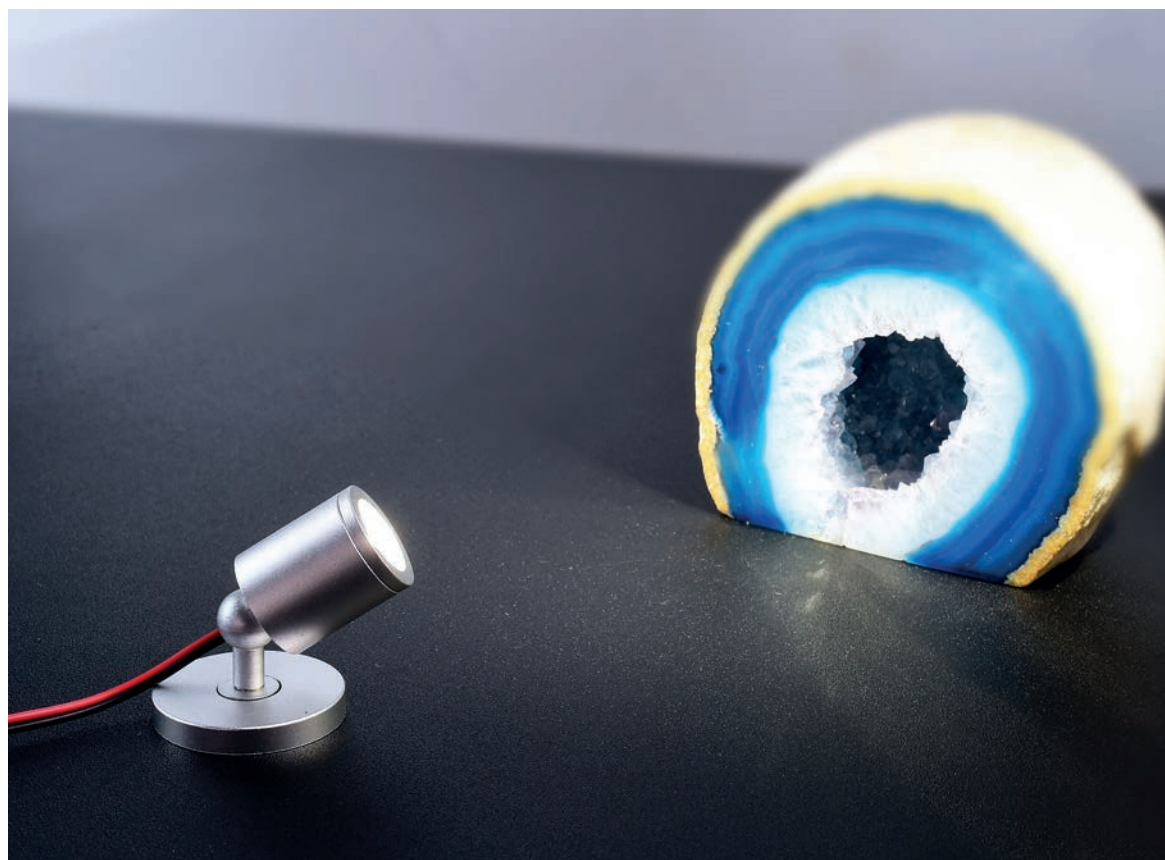



HERCULIS SMALL

- design optimised for cabinets and showcases
- high performance despite compact design
- for surface and recessed mounting thanks to intelligent cable routing
- ready-to-plug-in system
- rotatable and swivelling head
- aluminium diecast
- dimensions L x Ø: 150 x 39 mm
- socket H x Ø: 5 x 39 mm



item	colour	colour temperature	light current	price
688030	silver coloured	3000 K	100 lm	79,95 €
688029	black	3000 K	100 lm	79,95 €
688033	silver coloured	4000 K	100 lm	79,95 €
688031	black	4000 K	100 lm	79,95 €



accessories

930594	power supply 12W, ready to plug in incl. 3-way distributor	32,95 €
930592	power supply 20W, ready to plug in incl. 6-way distributor	39,95 €



HERCULIS BIG

- design optimised for cabinets and showcases
- high performance despite compact design
- for surface and recessed mounting thanks to intelligent cable routing
- ready-to-plug-in system
- rotatable and swivelling head
- aluminium diecast
- dimensions L x Ø: 250 x 39 mm
- socket H x Ø: 5 x 39 mm



item	colour	colour temperature	light current	price
688035	silver coloured	3000 K	100 lm	79,95 €
688034	black	3000 K	100 lm	79,95 €
688037	silver coloured	4000 K	100 lm	79,95 €
688036	black	4000 K	100 lm	79,95 €



accessories

930594	power supply 12W, ready to plug in incl. 3-way distributor	32,95 €
930592	power supply 20W, ready to plug in incl. 6-way distributor	39,95 €



HERCULIS DOUBLE

- design optimised for cabinets and showcases
- high performance despite compact design
- for surface and recessed mounting thanks to intelligent cable routing
- ready-to-plug-in system
- rotatable and swivelling head
- aluminium diecast
- dimensions L x Ø: 200 x 39 mm
- socket H x Ø: 5 x 39 mm

item	colour	colour temperature	light current	price
688039	silver coloured	3000 K	185 lm	115,95 €
688038	black	3000 K	185 lm	115,95 €
688041	silver coloured	4000 K	195 lm	115,95 €
688040	black	4000 K	195 lm	115,95 €



accessories

930594	power supply 12W, ready to plug in incl. 3-way distributor	32,95 €
930592	power supply 20W, ready to plug in incl. 6-way distributor	39,95 €



HERCULIS TRIPLE

- design optimised for cabinets and showcases
- high performance despite compact design
- for surface and recessed mounting thanks to intelligent cable routing
- ready-to-plug-in system
- rotatable and swivelling head
- aluminium diecast
- dimensions L x Ø: 250 x 39 mm
- socket H x Ø: 5 x 39 mm

item	colour	colour temperature	light current	price
688043	silver coloured	3000 K	263 lm	135,95 €
688042	black	3000 K	263 lm	135,95 €
688045	silver coloured	4000 K	290 lm	135,95 €
688044	black	4000 K	290 lm	135,95 €



accessories

930594	power supply 12W, ready to plug in incl. 3-way distributor	32,95 €
930592	power supply 20W, ready to plug in incl. 6-way distributor	39,95 €







□ □ ■ □
page 225



□ □ ■ □
page 227



□ □
page 229



■ □ □
page 230



□ □ ■
page 233



□ □ ■
page 235



□ □
page 237



□
page 239



□
page 235



□ □ ■
page 243



□ □ ■
page 245



□ □ ■
page 247



□ □ ■
page 249

office lights

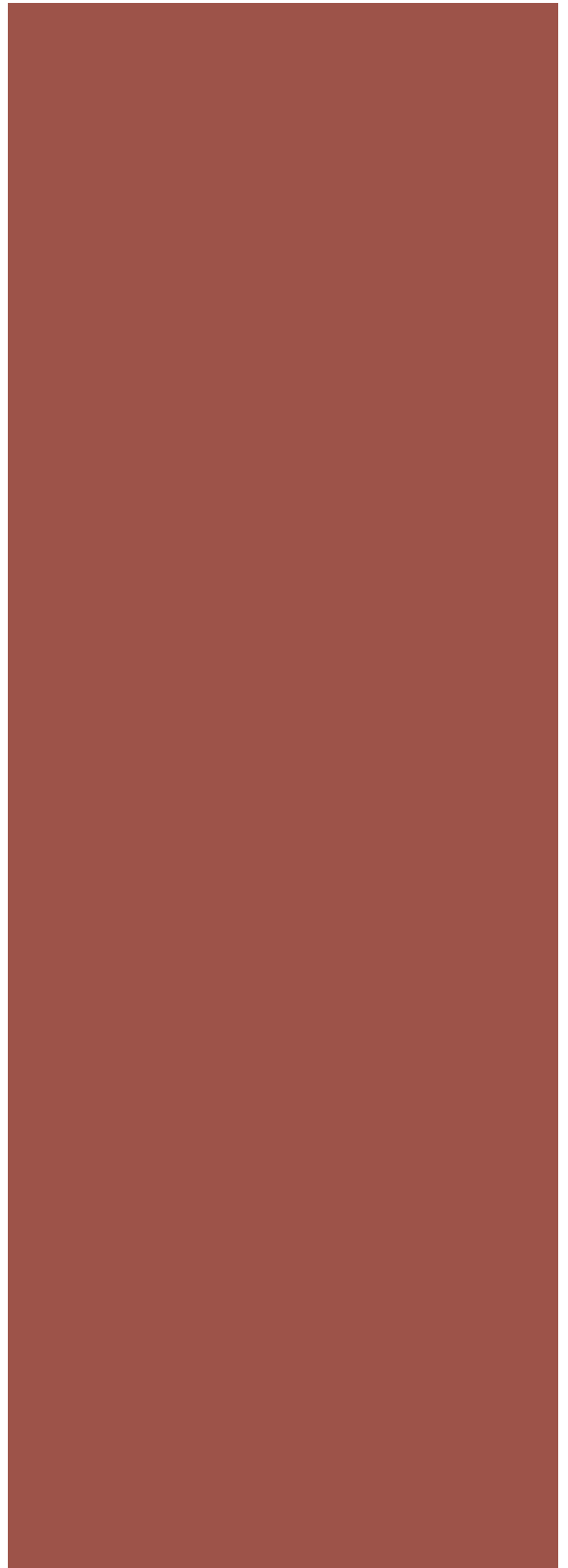



D PROFESSION DOWN

Thanks to their flexible control options, you can use the D PROFESSION pendant luminaires in both private and commercial applications. In the private sector, the dimmable down version creates a great lighting mood that harmonises perfectly with its modern design.



D PROFESSION DOWN

- powerful light output
- UGR <19
- ideal for home office or dining / living area
- aluminium
- dimensions L x W x H: 1177 x 53 x 53 mm
- socket L x W x H: 560 x 65 x 38 mm
- max. suspension: 3000 mm

item	colour	colour temperature	light current	control	price
620107	white	4000 K	3165 lm	phase control or phase cut-off	329,95 €
620110	silver coloured	4000 K	3165 lm	phase control or phase cut-off	329,95 €
620103	black	4000 K	3165 lm	phase control or phase cut-off	329,95 €
620106	white	4000 K	3165 lm	1-10V	339,95 €
620109	silver coloured	4000 K	3165 lm	1-10V	339,95 €
620102	black	4000 K	3165 lm	1-10V	339,95 €
620105	white	4000 K	3165 lm	DALI Bus according to IEC62386 DALI 1	359,95 €
620108	silver coloured	4000 K	3165 lm	DALI Bus according to IEC62386 DALI 1	359,95 €
620057	black	4000 K	3165 lm	DALI Bus according to IEC62386 DALI 1	359,95 €

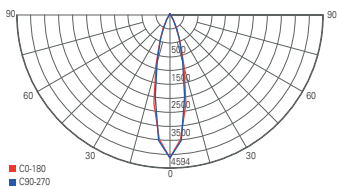
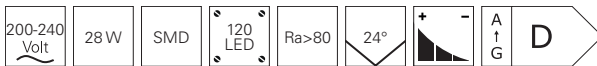

light distribution curve



D PROFESSION UP AND DOWN

Thanks to their flexible control options, you can use the D PROFESSION pendant luminaires in both private and commercial applications. The UP and Down version emits its light in two directions. While the upward LEDs create a pleasant, indirect room light, the downward LEDs provide a defined, powerful and UGR-compliant office and task light for desks and more.



D PROFESSION UP AND DOWN

- powerful light output
- UGR <19
- ideal for home office or dining / living area
- aluminium
- dimensions L x W x H: 1177 x 53 x 53 mm
- socket L x W x H: 560 x 65 x 38 mm
- max. suspension: 3000 mm
- incl. uplight for indirect light

item	colour	colour temperature	light current	control	price
620111	white	4000 K	7180 lm	phase control or phase cut-off	399,95 €
620104	silver coloured	4000 K	7180 lm	phase control or phase cut-off	399,95 €
620112	black	4000 K	7180 lm	phase control or phase cut-off	399,95 €
620114	white	4000 K	7180 lm	1-10V	399,95 €
620113	silver coloured	4000 K	7180 lm	1-10V	399,95 €
620115	black	4000 K	7180 lm	1-10V	399,95 €
620117	white	4000 K	7180 lm	DALI Bus according to IEC62386 DALI 1	429,95 €
620116	silver coloured	4000 K	7180 lm	DALI Bus according to IEC62386 DALI 1	429,95 €
620118	black	4000 K	7180 lm	DALI Bus according to IEC62386 DALI 1	429,95 €

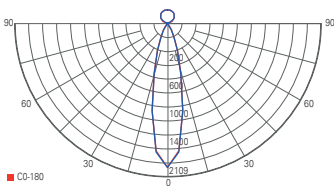
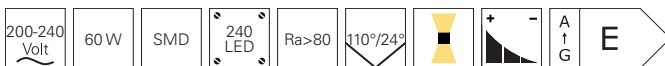

light distribution curve



With the kind support of WIBU-SYSTEMS AG Karlsruhe

OFFICE THREE DALI 2.0

The pendant luminaire is a matching addition to the OFFICE THREE floor lamp. As the glare value is less than 10, this technically sophisticated luminaire can almost be described as completely glare-free. The upward-facing LEDs create ambient light, while the downward-facing LEDs shine clearly defined and powerful light onto the work area.



OFFICE THREE DALI 2.0

- aluminium
- dimensions L x W x H: 1179 x 64 x 35 mm
- socket L x W x H: 600 x 57 x 35 mm
- max. suspension: 2500 mm
- UGR<10
- BEG eligible
- dimmable via DALI Bus according to IEC62386 DALI 2.0
- incl. uplight for indirect light
- lifetime 50,000h L80B10

item	colour	colour temperature	light current	price
342147	<input type="checkbox"/> white	<input type="checkbox"/> 4000 K	7000 lm	599,95 €
342146	<input type="checkbox"/> silver coloured	<input type="checkbox"/> 4000 K	7000 lm	599,95 €

200-240 Volt	58 W	SMD	176 LED	Ra>80	115° / 55°			A t G	E
--------------	------	-----	---------	-------	------------	--	--	-------	---

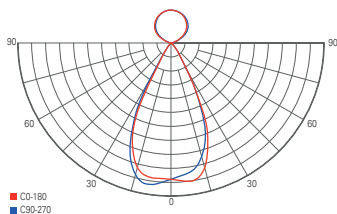

light distribution curve

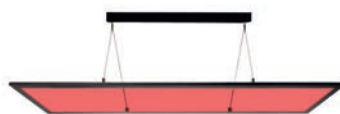
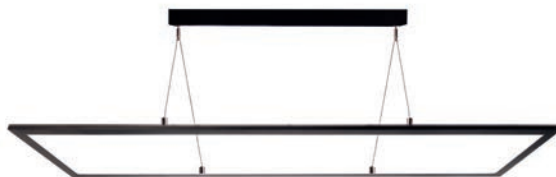

LED EVENT-PANEL TRANSPARENT RGBW

- aluminium
- dimensions L x W x H: 1195 x 295 x 14 mm
- dimmable via optional controller

item	colour	colour temperature	light current	EEL	price
342158	■ black clear / transparent	4000 K	4220 lm	D	279,95 €
620032	□ white clear / transparent	4000 K	4265 lm	E	279,95 €
620031	■ black clear / transparent	4000 K	4265 lm	E	279,95 €



optionales accessories

862164	power supply 24V DC 75,0 W	74,95 €
843502	RF-smart controller starter set RGBW 12/24/48V	99,95 €
843037	Casambi Bluetooth dimmer 4 channel 12/24V	179,95 €
843010	DALI DT6 PWM dimmer 4 channel 12/24V	129,95 €
843000	DMX controller Art-4	229,95 €
843279	DMX PWM dimmer 4 channel 12/24/48V	114,95 €

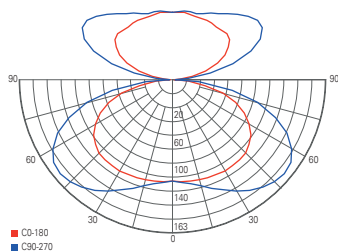

light distribution curve





LED PANEL TRANSPARENT ROUND

The special feature of this pendant luminaire is the transparent light body. When switched off, the surface is almost completely transparent. When the light is switched on, the disc distributes the light almost glare-free. With a glare value [UGR] of less than 19, this pendant luminaire is absolutely suitable for office use. Bright, efficient and with an extraordinary design, this luminaire stands out in any office setting.



LED PANEL TRANSPARENT ROUND

- aluminium
- dimensions H x Ø: 12,50 x 580 mm
- socket H x Ø: 45,00 x 250 mm
- max. suspension: 1500 mm
- UGR <19
- dimmable via phase control or phase cut-off
- almost transparent when switched off

item	colour	colour temperature	light current	price
342091	<input type="checkbox"/> white	3000 K	5100 lm	379,95 €
342094	<input type="checkbox"/> white	4000 K	5600 lm	379,95 €
342090	<input type="checkbox"/> aluminium	3000 K	5100 lm	379,95 €
342093	<input type="checkbox"/> aluminium	4000 K	5600 lm	379,95 €
342089	<input type="checkbox"/> black	3000 K	5100 lm	379,95 €
342092	<input type="checkbox"/> black	4000 K	5600 lm	379,95 €

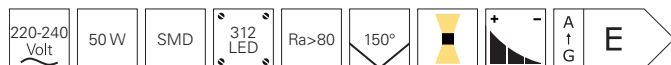

suitable
floor light
page 239
343022

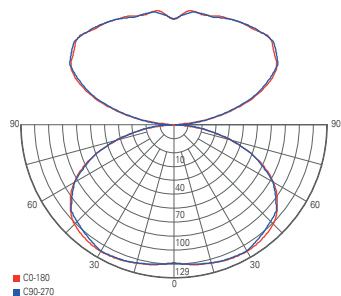

light distribution curve



LED PANEL TRANSPARENT

The LED pendant luminaire has a transparent glass for direct and indirect light distribution, which is almost transparent when switched off. When the light is switched on, the glass distributes the light almost glare-free. With a glare value [UGR] of less than 19, this pendant luminaire is absolutely suitable for office use. Bright, efficient and with an extraordinary design, this luminaire not only stands out in any office setting.

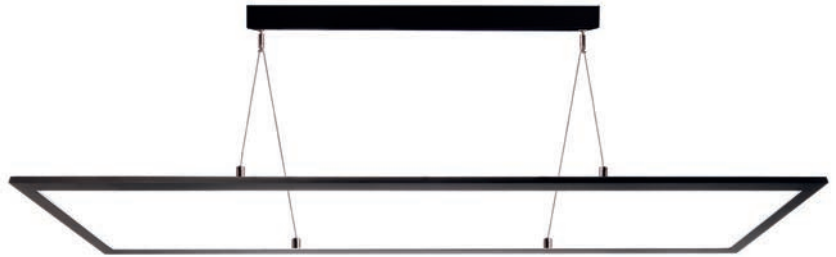
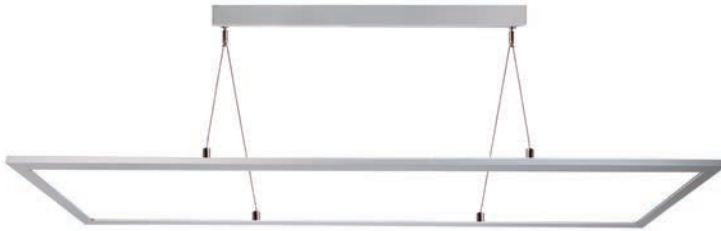

LED PANEL TRANSPARENT

- aluminium
- dimensions L x W x H: 1195 x 295 x 12 mm
- socket L x W x H: 580 x 80 x 40 mm
- max. suspension: 1800 mm
- UGR <19
- BEG eligible [4000K]
- dimmable via phase control or phase cut-off
- almost transparent when switched off
- panel designed to IP40

item	colour	colour temperature	light current	price
342221	<input type="checkbox"/> white	3000/4000 K	5600/6100 lm	299,95 €
342220	<input type="checkbox"/> aluminium	3000/4000 K	5600/6100 lm	299,95 €
342219	<input type="checkbox"/> black	3000/4000 K	5600/6100 lm	299,95 €



suitable
floor light
page 239
343022





motion sensor
and daylight sensor

MOTION SENSOR

- the luminaire switches on automatically when there is movement
- without movement, the brightness is reduced to 30% after 30 min
- without movement, the luminaire switches off after 30 min.

DAYLIGHT SENSOR

- switch on the luminaire and dim it to the desired brightness dim [this setting is saved by the daylight sensor as the saves this setting as default]
- if the ambient light changes, the sensor adjusts the brightness to the stored standard [10% tolerance]





touch dimmer



OFFICE ONE + MOTION

- UGR<19
- SDCM <3
- service life 50.000h L80B10
- aluminium
- dimensions L x W x H: 1950 x 310 x 30 mm
- socket L x W: 460 x 300 mm
- gap size socket: 100 mm
- dimmable via touch sensor
- incl. 1,5 m connection cable Schuko plug and cold-device plug C21

item	colour	colour temperature	light current	sensor system	price
343034	silver coloured	3000 K	6700 lm		819,95 €
343030	silver coloured	4000 K	7400 lm		819,95 €
343035	silver coloured	3000 K	6700 lm	motion and daylight sensor	949,95 €
343032	silver coloured	4000 K	7400 lm	motion and daylight sensor	949,95 €

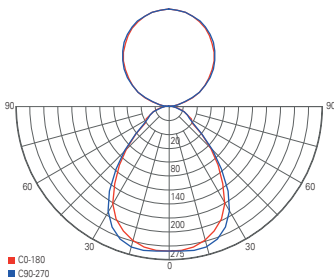

light distribution curve





touch dimmer



OFFICE ONE TRANSPARENT

- UGR<19
- BEG eligible
- service life 50.000h L80B10
- aluminium
- dimensions L x W x H: 1950 x 310 x 20 mm
- socket L x W: 460 x 30 mm
- dimmable via touch sensor
- almost transparent when switched off
- incl. 2,5 m connection cable with connector



item	colour	colour temperature	light current	price
343022	□ silver coloured	nw 4000 K	6200 lm	819,95 €

100-277 Volt	50 W	SMD	180 LED	Ra>80	150°/150°	+	-	A ↑ G	E
--------------	------	-----	---------	-------	-----------	---	---	-------------	---

suitable
pendant lights
page 235
342221
342220
342219

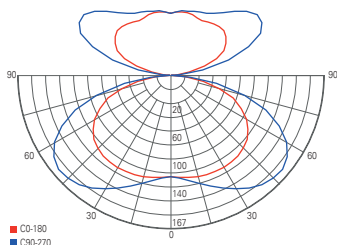

light distribution curve





rotary switch



OFFICE TWO

- UGR<19
- SDCM <3
- service life 50.000h L80B10
- aluminium
- dimensions L x W x H: 1950 x 310 x 42 mm
- socket L x W: 450 x 270 mm
- dimmable via rotary switch
- incl. 2,5 m connection cable with mains plug

item	colour	colour temperature	light current	price
343016	□ silver coloured	■ 4000 K	8300 lm	749,95 €

100-277 Volt	80 W	SMD	288 LED	Ra>80	115°/75°	+	-	A † G	E
--------------	------	-----	---------	-------	----------	---	---	-------------	---

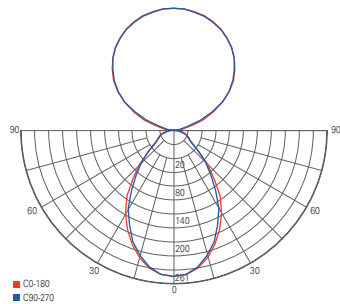

light distribution curve

RADAR PRESENCE DETECTOR

- the luminaire switches on automatically at the slightest movement
- without movement, the brightness is reduced to 30% after 5/15/30 minutes [time adjustable]
- without movement, the luminaire switches off after further 5/15/30 minutes

DAYLIGHT SENSOR

- switch on the luminaire and dim it to the desired brightness [this setting is saved as a default by the daylight sensor]
- if the ambient light changes, the sensor adjusts the brightness to the stored standard [10% tolerance]



UNIVERSAL TABLE CLAMP

- The table clamp can be used for table tops with a total thickness of 15-65 mm [incl. substructure] as required.
- If part of the frame construction is located within the clamping area of the luminaire, the supplied hard rubber buffers should be used to compensate for the unevenness and to create a surface-flush clamping area.
- Due to the design of the table clamp, mounting on almost all table tops is possible.



OPTIONAL MOUNTING KIT

- For larger table tops, or if positioning on the table is desired, the optional mounting kit can be used instead of the pre-installed table clamp. This is simply mounted through a drill hole in the table.
- suitable for table tops of 15-35 mm total thickness
- suitable for hole diameters of 22-30 mm mounting kit

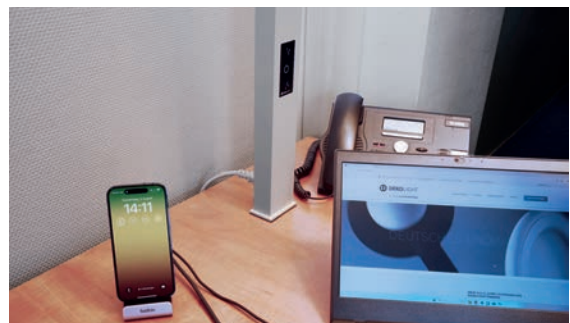



OFFICE THREE STANDARD TABLE

- UGR<6
- SDCM <3
- Lifetime 50.000h L80B10
- BEG eligible
- suitable for VDU workstations according to EN 12464-1 BAP65 [L65 ≤ 3000cd/m²]
- optimal for high-quality illumination of height-adjustable individual workstations
- newly designed and extended luminaire head for ideal illumination of 160x80cm tables
- aluminium
- dimensions L x W x H: 1159 x 64 x 1194 mm
- base L x W: 500 x 225 mm
- gap size base: 100 mm
- suitable for table constructions with 15-65 mm thickness
- CRI>95 for direct light
- direct and indirect light separately via touch panel dimmable and switchable
- high-precision radar presence detector detects the slightest movements
- sensor run-on time adjustable [5 / 15 / 30 min]
- daylight sensor for dynamic brightness adjustment
- incl. 2.5 m connection cable with shock-proof plug and cold appliance plug C21
- incl. hard rubber buffers for underlaying table constructions running close to the edge



sensor



touch dimmer



table clamp

item	colour	colour temperature	luminous flux	price
346063	white	4000 K	10100 lm	999,95 €
346064	silver coloured	4000 K	10100 lm	999,95 €
346065	black	4000 K	10100 lm	999,95 €



accessories

930727	mounting kit for drill hole white	39,95 €
930728	mounting kit for drill hole aluminium	39,95 €
930729	mounting kit for drill hole black	39,95 €



RADAR PRESENCE DETECTOR

- the luminaire switches on automatically at the slightest movement
- without movement, the brightness is reduced to 30% after 5/15/30 minutes [time adjustable]
- without movement, the luminaire switches off after further 5/15/30 minutes

DAYLIGHT SENSOR

- switch on the luminaire and dim it to the desired brightness [this setting is saved as a default by the daylight sensor]
- if the ambient light changes, the sensor adjusts the brightness to the stored standard [10% tolerance]

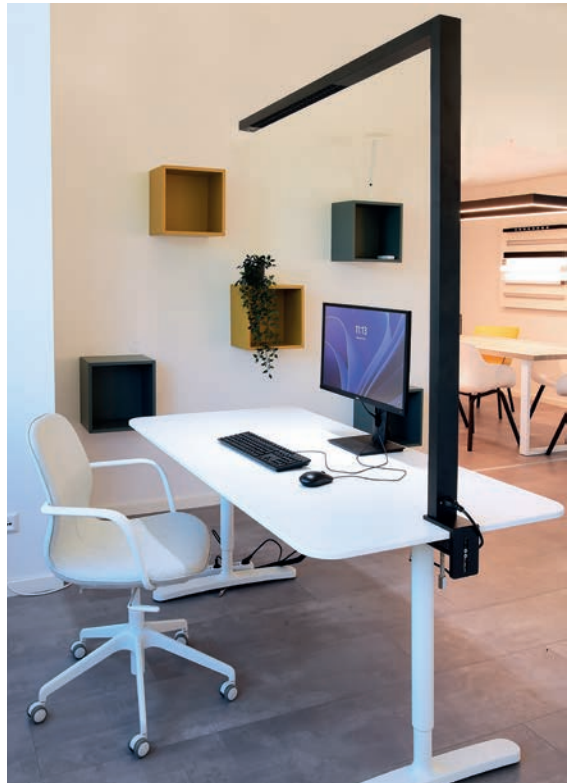

UNIVERSAL TABLE CLAMP

- The table clamp can be used for table tops with a total thickness of 15-65 mm [incl. substructure] as required.
- If part of the frame construction is located within the clamping area of the luminaire, the supplied hard rubber buffers should be used to compensate for the unevenness and to create a surface-flush clamping area.
- Due to the design of the table clamp, mounting on almost all table tops is possible.



OPTIONAL MOUNTING KIT

- For larger table tops, or if positioning on the table is desired, the optional mounting kit can be used instead of the pre-installed table clamp. This is simply mounted through a drill hole in the table.
- suitable for table tops of 15-35 mm total thickness
- suitable for hole diameters of 22-30 mm mounting kit

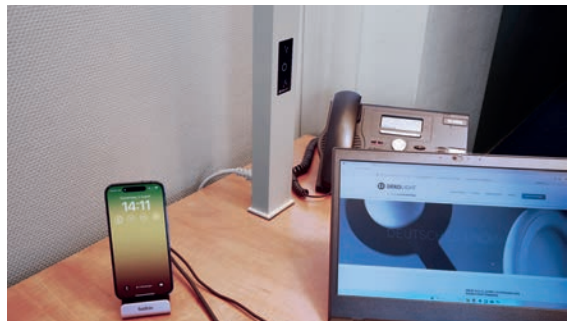



OFFICE THREE PRO TABLE

- UGR<6
- SDCM <3
- Lifetime 50.000h L80B10
- BEG eligible
- suitable for VDU workstations according to EN 12464-1 BAP65 [L65 <= 3000cd/m²]
- optimal for high-quality illumination of height-adjustable individual workstations
- newly designed and extended luminaire head for ideal illumination of 160x80cm tables
- aluminium
- dimensions L x W x H: 1159 x 64 x 1194 mm
- base L x W: 500 x 225 mm
- gap size base: 100 mm
- suitable for table constructions with 15-65 mm thickness
- CRI>95 for direct light
- direct and indirect light separately via touch panel dimmable and switchable
- light colour adjustable via touch panel
- high-precision radar presence detector detects the slightest movements
- daylight sensor for dynamic brightness adjustment
- incl. 2.5 m connection cable with shock-proof plug and cold appliance plug C21
- incl. hard rubber buffers for underlaying table constructions running close to the edge



sensor



touch dimmer



table clamp

item	colour	colour temperature	luminous flux	price
346066	white	2700-6500 K	9800 lm	1.199,95 €
346067	silver coloured	2700-6500 K	9800 lm	1.199,95 €
346068	black	2700-6500 K	9800 lm	1.199,95 €



accessories

930727	mounting kit for drill hole white	39,95 €
930728	mounting kit for drill hole aluminium	39,95 €
930729	mounting kit for drill hole black	39,95 €





With the kind support of Salvia Elektrotechnik GmbH

RADAR PRESENCE DETECTOR

- the luminaire switches on automatically at the slightest movement
- without movement, the brightness is reduced to 30% after 5/15/30 minutes [time adjustable]
- without movement, the luminaire switches off after further 5/15/30 minutes

DAYLIGHT SENSOR

- switch on the luminaire and dim it to the desired brightness [this setting is saved as a default by the daylight sensor]
- if the ambient light changes, the sensor adjusts the brightness to the stored standard [10% tolerance]

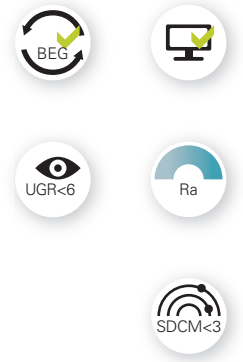

sensor



touch dimmer

OFFICE THREE STANDARD FLOOR

- UGR<6
- SDCM <3
- Lifetime 50.000h L80B10
- BEG eligible
- suitable for VDU workstations according to EN 12464-1 BAP65 [L65 ≤ 3000cd/m²]
- optimal for high-quality illumination of individual workstations
- newly designed and extended luminaire head for ideal illumination of 160 x 80 cm tables
- aluminium
- dimensions L x W x H: 1240 x 64 x 1950 mm
- CRI>95 for direct light
- direct and indirect light separately via touch panel dimmable and switchable
- light colour adjustable via touch panel
- high-precision radar presence detector detects the slightest movements
- daylight sensor for dynamic brightness adjustment
- incl. 2.5 m connection cable with shock-proof plug and cold appliance plug C21

item	colour	colour temperature	luminous flux	price
342228	<input type="checkbox"/> white	<input type="checkbox"/> 4000 K	10100 lm	1.199,95 €
342229	<input type="checkbox"/> silver coloured	<input type="checkbox"/> 4000 K	10100 lm	1.199,95 €
342230	<input type="checkbox"/> black	<input type="checkbox"/> 4000 K	10100 lm	1.199,95 €





With the kind support of Salvia Elektrotechnik GmbH

RADAR PRESENCE DETECTOR

- the luminaire switches on automatically at the slightest movement
- without movement, the brightness is reduced to 30% after 5/15/30 minutes [time adjustable]
- without movement, the luminaire switches off after further 5/15/30 minutes

DAYLIGHT SENSOR

- switch on the luminaire and dim it to the desired brightness [this setting is saved as a default by the daylight sensor]
- if the ambient light changes, the sensor adjusts the brightness to the stored standard [10% tolerance]

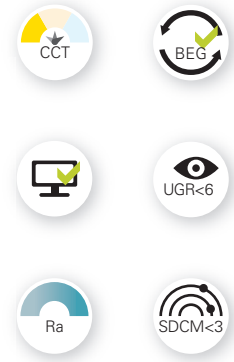

sensor



touch dimmer

OFFICE THREE PRO FLOOR

- UGR<6
- SDCM <3
- Lifetime 50.000h L80B10
- BEG eligible
- suitable for VDU workstations according to EN 12464-1 BAP65 [L65 ≤ 3000cd/m²]
- optimal for high-quality illumination of individual workstations
- newly designed and extended luminaire head for ideal illumination of 160 x 80 cm tables
- aluminium
- dimensions L x W x H: 1240 x 64 x 1950 mm
- CRI>95 for direct light
- direct and indirect light separately via touch panel dimmable and switchable
- high-precision radar presence detector detects the slightest movements
- sensor run-on time adjustable [5 / 15 / 30 min]
- daylight sensor for dynamic brightness adjustment
- incl. 2.5 m connection cable with shock-proof plug and cold appliance plug C21

item	colour	colour temperature	luminous flux	price
342231	<input type="checkbox"/> white	ww cw 2700-6500 K	9800 lm	1.399,95 €
342232	<input type="checkbox"/> silver coloured	ww cw 2700-6500 K	9800 lm	1.399,95 €
342233	<input type="checkbox"/> black	ww cw 2700-6500 K	9800 lm	1.399,95 €





page 252



page 254



page 257

hall floodlight



VEGA

The VEGA high bay floodlight - quality that convinces. In industrial / storage halls or similar, the hall floodlight is the perfect solution when it comes to first-class lighting. In the version with three adjustable power levels, they adapt to your requirements. At the same time, the spotlights are particularly energy-efficient, which has a positive effect on your operating costs. With a long service life of 50,000 hours [L80B20], they provide long-lasting, reliable lighting without compromise. Thanks to optional lenses, VEGA spotlights can achieve a UGR value of less than 19 to ensure glare-free light. And for those who want precise lighting control, we offer variants with Dali control. In addition, the high-bay spotlights are BEG subsidy-eligible.



VEGA

- high-quality, versatile and powerful hall downlight
- power adjustable in three stages
- particularly energy-efficient
- service life 50,000 h L80B20
- BEG eligible
- UGR<19 with optional lens
- aluminium diecast
- incl. 1.5 m connection cable

item	colour	colour temperature	light current	power	dimensions H x Ø	price
732156	■ black	nw 4000 K	15300 / 23400 / 28800 lm	90 / 130 / 160 W	120 x 400 mm	319,95 €
732158	■ black	cv 5700 K	15300 / 23400 / 28800 lm	90 / 130 / 160 W	120 x 400 mm	319,95 €



accessories

930743	lens 60°	49,95 €
930641	suspension set 1m chain	14,95 €
930685	suspension set 3m chain	24,95 €
930742	wall mounting arm OnOff	39,95 €







VEGA DALI

- high-quality, versatile and powerful hall downlight
- particularly energy-efficient
- service life 50,000 h L80B20
- BEG eligible
- UGR<19 with optional lens
- aluminium diecast
- incl. 1.5 m connection cable

item	colour	colour temperature	light current	power	control	dimensions H x Ø	price
732157	■ black	nw 4000 K	28800 lm	160 W	DALI 2 / DT6	122 x 400 mm	369,95 €
732159	■ black	cw 5700 K	28800 lm	160 W	DALI 2 / DT6	122 x 400 mm	369,95 €



accessories

930743	lens 60°	49,95 €
930641	suspension set 1m chain	14,95 €
930685	suspension set 3m chain	24,95 €
930775	wall mounting arm DALI	39,95 €



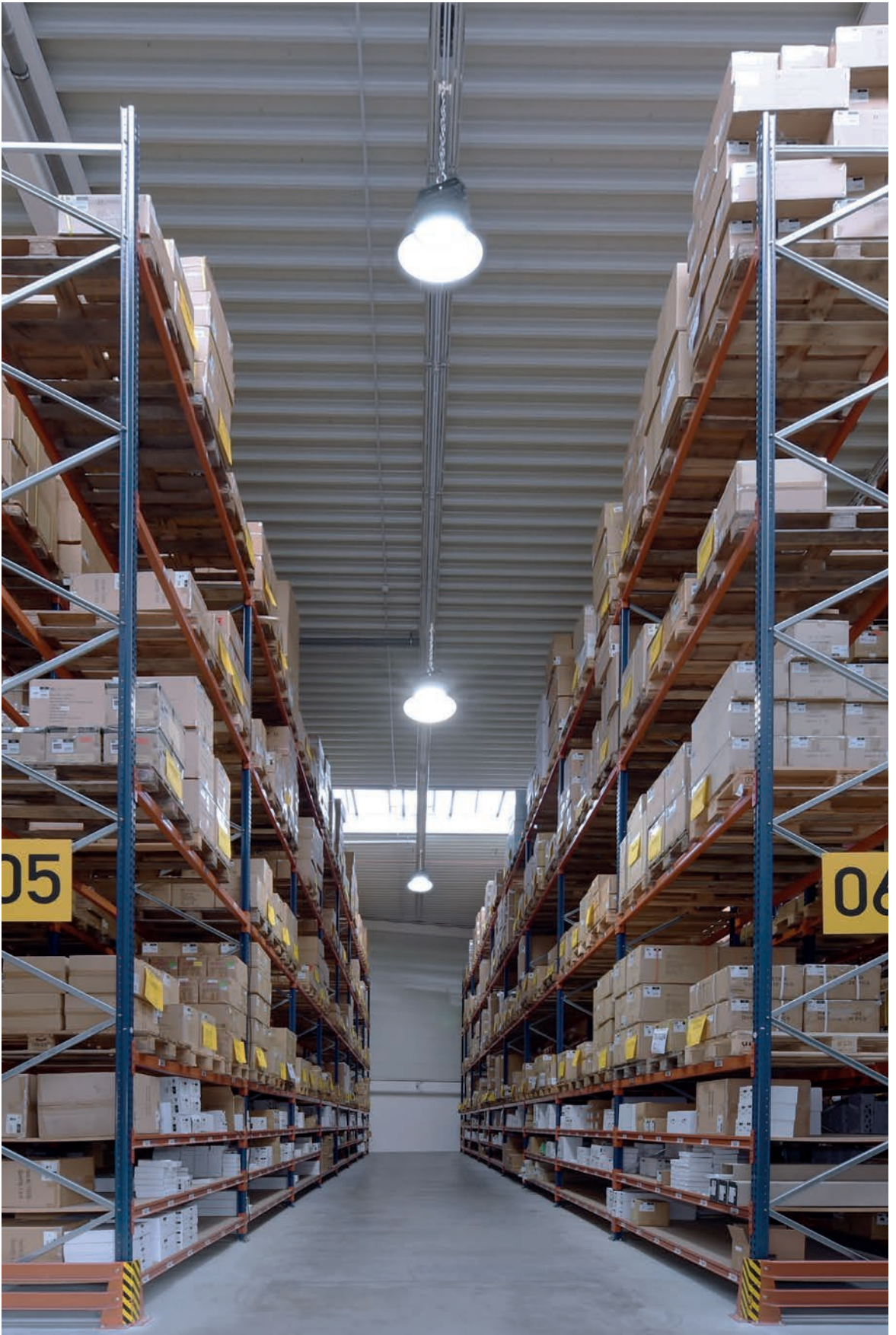



HIGHBAY NORMAE

The energy-efficient Highbay spotlights are ideal for hall lighting. Thanks to the adjustable mounting set, the spotlights can be mounted at the desired angle of inclination. With the corresponding set, there is also the option of suspending them and, if required, equipping them with asymmetrical lenses.

HIGHBAY NORMAE

- BEG eligible
- aluminium diecast
- socket L x W x H: 110 x 70 x 95 mm
- DALI Bus according to IEC62386 DALI 1.0
- incl. verstellbarem Befestigungsset



item	colour	colour temperature	light current	dimensions L x W x H	power	light source	price
732084	■ dunkelgrau	■ cw 5000 K	16700 lm	923 x 126 x 99 mm	136 W	192 LED	399,95 €
732085	■ dunkelgrau	■ cw 5000 K	23800 lm	1219 x 126 x 99 mm	172 W	236 LED	499,95 €

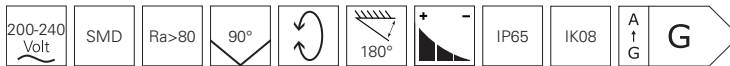

accessories

- 930295** linear Highbase lens 30°/70° 290 x 86 x 8 mm **14,95 €**
930293 suspension set 1m chain **39,95 €**

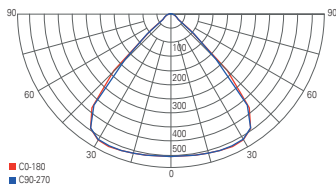
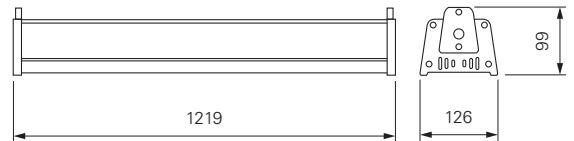
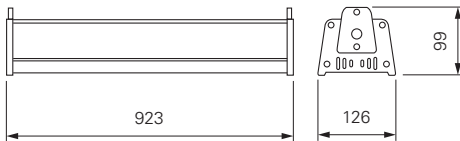

light distribution curve 732084 mit Linse 90°

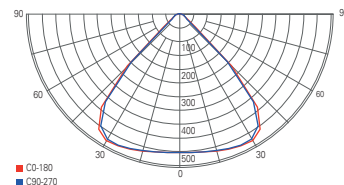

light distribution curve 732085 mit Linse 90°

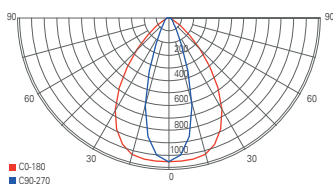

light distribution curve 732084 mit Linse 30°/70°

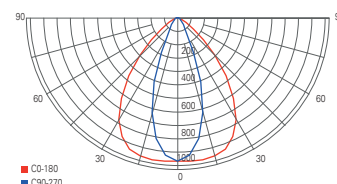

light distribution curve 732085 mit Linse 30°/70°



page 261



page 261



page 263



page 265



page 266



page 267



page 267

damp-proof luminaires





With the kind support of WIBU-SYSTEMS AG Karlsruhe

TRI PROOF BASIC

Discover our TRI PROOF BASIC damp-proof luminaire. The luminaires are BEG eligible and particularly energy-efficient - this means lower operating costs for your customers. With their robust construction and long service life, the luminaires are very durable. The pre-installed through-wiring and the practical cable entries on the back significantly simplify the installation. The metal clips ensure reliable locking. In addition, we offer variants with a motion detector where the brightness level, the detection range and the switch-off interval can be adjusted.



through-wiring



safe assembly
thanks to safety rope

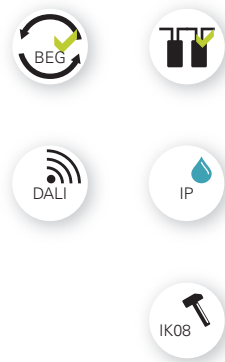

TRI PROOF BASIC

- BEG eligible
- particularly energy-efficient
- long service life 50,000h L80B50
- through-wiring 3x1.5mm² / 5x1,5mm² [DALI] pre-installed
- cable entry at the rear
- stainless steel clamps on the cover can be locked with screws
- robust plastic housing made of polycarbonate [PC]

item	colour	colour temperature	light current	dimensions L x W x H	power	control	price
730483	grey	4000 K	2520 lm	610 x 82 x 75 mm	18 W		54,95 €
730486	grey	4000 K	5040 lm	1210 x 82 x 75 mm	36 W		79,95 €
730489	grey	4000 K	7700 lm	1510 x 82 x 75 mm	55 W		94,95 €
730485	grey	4000 K	2520 lm	610 x 82 x 75 mm	18 W	DALI 2 / DT6	104,95 €
730488	grey	4000 K	5040 lm	1210 x 82 x 75 mm	36 W	DALI 2 / DT6	129,95 €
730491	grey	4000 K	7700 lm	1510 x 82 x 75 mm	55 W	DALI 2 / DT6	159,95 €



accessories

930713 rope suspension 19,95 €



TRI PROOF BASIC MOTION

- BEG eligible
- particularly energy-efficient
- long service life 50,000h L80B50
- through-wiring 3x1.5mm² pre-installed
- cable entry at the rear
- stainless steel clamps on the cover can be locked with screws
- robust plastic housing made of polycarbonate [PC]
- adjustable radar motion sensor

item	colour	colour temperature	light current	dimensions L x W x H	power	price
730484	grey	4000 K	2520 lm	610 x 82 x 75 mm	18 W	74,95 €
730487	grey	4000 K	5040 lm	1210 x 82 x 75 mm	36 W	99,95 €
730490	grey	4000 K	7700 lm	1510 x 82 x 75 mm	55 W	114,95 €



accessories

930713 rope suspension 19,95 €





With the kind support of WIBU-SYSTEMS AG Karlsruhe

TRI PROOF SLIM

Waterproof, impact-resistant and versatile – the surface-mounted ceiling luminaires of the TRI PROOF SLIM series are flexible workhorses with an innovative design. Whether in wet areas, cellars, workshops, garages or warehouses – the IP68-certified SLIMS are impact-resistant up to IK10 and their beam angle can be continuously adjusted.



TRI PROOF SLIM

- robust plastic housing
- light direction continuously selectable by turning
- easy installation in existing fixings [e.g. pipe clamps]
- simple connection due to screwless terminals
- simple through-wiring [2x 1.5mm² without protective earth]
- incl. 4x screws, 4x dowels, 2x bracket clip, 2x quick connection clip, 1x cable connection cap

item	colour	colour temperature	light current	dimensions L x Ø	power	price
348138	<input type="checkbox"/> white	<input checked="" type="checkbox"/> cw 5000 K	2265 lm	700 x 39 mm	21 W	89,95 €
348139	<input type="checkbox"/> white	<input checked="" type="checkbox"/> cw 5000 K	4575 lm	1300 x 39 mm	40 W	149,95 €



through-wiring

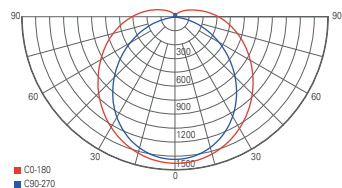

light distribution curve 348138

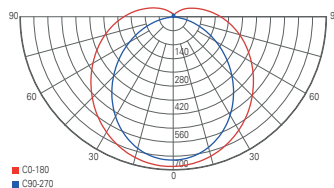

light distribution curve 348139



TRI PROOF

Equipped with LEDs in neutral white light colour [4000 K], the TRIPROOF LED IP65 moisture-proof luminaire consists of a light grey polycarbonate housing and a satinised polycarbonate cover in one piece. It is suitable for simple ceiling, wall or pendant mounting and is available in three different lengths.

Several can be strung together; ideal for industrial and private use, e.g. for lighting under canopies, in basements, workshops, garages, industrial halls, etc. The luminaire is provided with a simple electrical connection with plug-in terminal.





TRI PROOF

- robust plastic housing
- pre-installed through-wiring [2x1,5mm²]
- stackable up to 25 [730419] / 15 [730424] / 10 [730425] piece
- incl. mountings clips

item	colour	colour temperature	light current	dimensions L x W x H	power	price
730419	<input type="checkbox"/> white	4000 K	1430 lm	696 x 61 x 56 mm	16,80 W	49,95 €
730424	<input type="checkbox"/> white	4000 K	2980 lm	1296 x 61 x 56 mm	34,40 W	79,95 €
730425	<input type="checkbox"/> white	4000 K	3820 lm	1598 x 61 x 56 mm	43,60 W	84,95 €



accessories

- 930071** wire suspension 2 pcs. | L: 2500 mm **14,95 €**
- 930072** mounting fixation 2 pcs. **14,95 €**

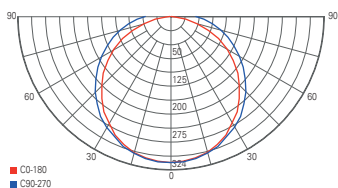

light distribution curve 730419

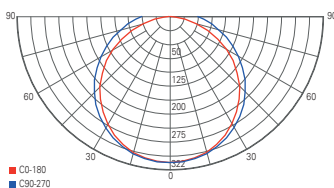

light distribution curve 730424

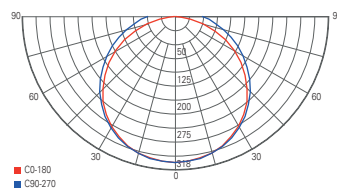

light distribution curve 730425

TRI PROOF MOTION

The ideal luminaire for environments with increased lighting requirements: whether in the garage, in the cellar or for the carport – the surface-mounted TRI PROOF MOTION luminaire is protected against wind and weather thanks to IP65 certification and is of course equipped with an integrated, invisible motion sensor that can be adjusted via dip switch.



TRI PROOF MOTION

- robust plastic housing
- motion sensor
- pre-installed through-wiring [2x1,5mm²]
- incl. mountings clips

item	colour	colour temperature	light current	dimensions L x W x H	power	price
730450	<input type="checkbox"/> white	4000 K	1900 lm	61 x 56 x 665 mm	18 W	59,95 €
730455	<input type="checkbox"/> white	4000 K	2500 lm	61 x 56 x 1145 mm	24 W	74,95 €



accessories

930071	wire suspension 2 pcs. L: 2500 mm	14,95 €
930072	mounting fixation 2 pcs.	14,95 €

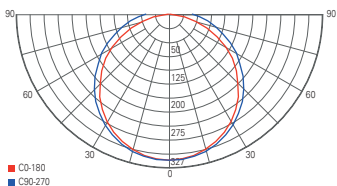

light distribution curve 730450

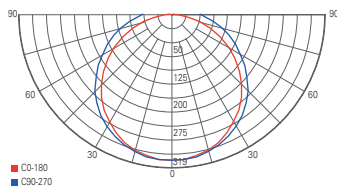

light distribution curve 730455



SYRMA OVAL

- plastic
- dimensions L x W x H: 180 x 125 x 105 mm
- socket L x W x H: 155 x 125 x 35 mm

item	colour	price
401011	<input type="checkbox"/> white	12,95 €
401013	<input type="checkbox"/> grey	12,95 €
401012	<input type="checkbox"/> black	12,95 €



suitable illuminants on page 803



SYRMA ROUND

- plastic
- dimensions H x Ø: 110 x 190 mm
- socket H x Ø: 35 x 160 mm

item	colour	price
401014	<input type="checkbox"/> white	19,95 €
401016	<input type="checkbox"/> grey	19,95 €
401015	<input type="checkbox"/> black	19,95 €



suitable illuminants on page 803



□ □
page 270



□
page 270



□ □
page 271



□ □
from page 272



□ □
from page 274

emergency lights



IP



EMERGENCY LIGHT ALMAAZ CONE

- plastic
- dimensions L x W x H: 283 x 50 x 187 mm
- single battery technology with LiFePO4 battery
- detection range 27m
- SK II / III with INSiLIA technology
- luminance 500cd/m²
- autotest function with buzzer
- rotatable housing for ceiling or wall mounting
- incl. changeable pictogram set in all directions

item	colour	colour temperature	price
348152	<input type="checkbox"/> white	NW 4500 K	199,95 €



optional accessories

930632	special pictogram First Aid Box green	119,95 €
930633	special pictogram fire extinguisher red	119,95 €
930634	battery bar 3,2V 1500mAh	59,95 €



IP

EMERGENCY LIGHT ALSAFI

- plastic
- dimensions L x W x H: 360 x 88 x 118 mm
- single battery technology with LiFePO4 battery
- detection range 16m
- SK II / III with INSiLIA technology
- luminance 500cd/m²
- autotest function with buzzer
- cut-outs for pendant mounting
- reflector with hinges
- suitable for ceiling or wall mounting
- incl. changeable pictogram set in all directions

item	colour	colour temperature	price
348140	<input type="checkbox"/> white	NW 4500 K	189,95 €



optional accessories

930634	battery bar 3,2V 1500mAh	59,95 €
---------------	------------------------------	----------------





EMERGENCY LIGHT ALMAAZ FLAT

- plastic
- dimensions L x W x H: 283 x 50 x 198 mm
- single battery technology with LiFePO4 battery
- detection range 27m
- SK II / III with INSILIA technology
- DIP switch for switching from 3 to 8h
- luminance 500cd/m²
- autotest function with buzzer
- rotatable housing for ceiling or wall mounting
- incl. changeable pictogram set in all directions



item	colour	colour temperature	price
348151	<input type="checkbox"/> white	<input checked="" type="checkbox"/> NW 4500 K	289,95 €



optional accessories

930632	special pictogram First Aid Box green	119,95 €
930633	special pictogram fire extinguisher red	119,95 €
930634	battery bar 3,2V 1500mAh	59,95 €



With the kind support of WIBU-SYSTEMS AG Karlsruhe

EMERGENCY LIGHT ALMACH FOR THE ILLUMINATION OF CORRIDORS

- Red Dot Award Winner 2017
- special lens for the illumination of escape routes or for area lighting
- plastic
- dimensions L x W x H: 192 x 101 x 57 mm
- single battery technology with LiFePO4 battery
- SK II / III with INSiLIA technology
- 3h/8h bridging time
- simple click mounting
- rotatable



item	colour	colour temperature	price
731142	<input type="checkbox"/> white	NW 4500 K	269,95 €



PHOTOMETRIC DATA

mounting height	a		b		c		d		c		d	
	area lighting				emergency exit lens							
	1 W	2 W	1 W	2 W	1 W	2 W	1 W	2 W	1 W	2 W	1 W	2 W
2,5 m	3,50	3,92	7,84	8,84	2,72	3,03	6,05	7,00	5,02	5,77	11,54	13,46
3,0 m	3,78	4,37	9,09	9,82	3,05	3,52	6,79	7,83	5,55	6,33	12,65	14,60
3,5 m	3,97	4,93	9,85	11,04	3,33	3,83	7,66	8,52	5,98	7,07	14,15	16,26
4,0 m	3,81	5,24	10,48	12,16	3,56	4,09	8,18	9,41	6,32	7,75	15,50	17,74
4,5 m	-	5,50	10,99	13,19	3,73	4,45	8,90	10,24	6,12	8,37	16,74	19,09
5,0 m	-	5,50	11,00	14,14	3,87	4,62	9,56	11,00	-	8,57	-	20,30
5,5 m	-	-	-	15,00	-	4,91	-	11,69	-	8,72	-	21,39
6,0 m	-	-	-	15,23	-	5,17	-	12,32	-	8,82	-	22,38
6,5 m	-	-	-	15,37	-	5,41	-	12,90	-	8,56	-	23,27
7,0 m	-	-	-	15,99	-	5,43	-	13,42	-	-	-	-
7,5 m	-	-	-	15,98	-	5,61	-	13,89	-	-	-	-

EMERGENCY LIGHT ALMACH FOR THE ILLUMINATION OF AREAS

- Red Dot Award Winner 2017
- special lens for the illumination of escape routes or for area lighting
- plastic
- dimensions L x W x H: 192 x 101 x 57 mm
- single battery technology with LiFePO4 battery
- SK II / III with INSILIA technology
- 3h/8h bridging time
- simple click mounting
- rotatable



item	colour	colour temperature	price
731143	<input type="checkbox"/> white	<input checked="" type="checkbox"/> 4500 K	269,95 €

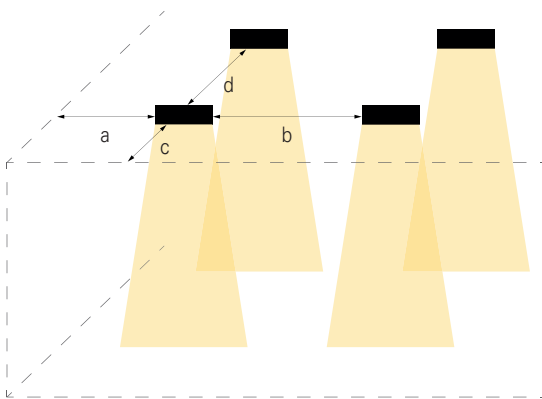

- a: distance from luminaire [narrow page] to wall
 b: distance from luminaire [narrow page] to luminaire [narrow page]
 c: distance from luminaire [long page] to wall
 d: distance from luminaire [long page] to luminaire [long page]

EMERGENCY LIGHT ALNAIR FOR THE ILLUMINATION OF AREAS

- special lens for the illumination of escape routes or for area lighting
- plastic
- dimensions H x Ø: 28 x 78 mm
- single battery technology with LiFePO4 battery
- SK II / III with INSiLIA technology
- 3h/8h bridging time



item	colour	colour temperature	price
565326	<input type="checkbox"/> white	NW 4500 K	289,95 €



PHOTOMETRIC DATA

mounting height	a		b		c		d		c		d	
	1 W	2 W	1 W	2 W	1 W	2 W	1 W	2 W	1 W	2 W	1 W	2 W
2,5 m	3,57	4,00	8,00	9,02	2,68	3,09	6,17	7,14	5,13	5,62	11,78	13,74
3,0 m	3,84	4,45	9,24	9,99	3,11	3,45	6,90	7,96	5,64	6,43	12,87	14,85
3,5 m	3,89	5,00	10,00	11,20	3,38	3,89	7,77	8,64	6,06	7,18	14,35	15,72
4,0 m	3,73	5,13	10,62	12,32	3,48	4,14	8,28	9,53	6,16	7,85	15,70	17,16
4,5 m	2,00	5,56	11,11	13,34	3,78	4,50	9,00	10,35	-	8,12	-	19,30
5,0 m	1,92	5,55	11,11	14,28	3,91	4,66	9,66	11,11	-	8,66	-	20,50
5,5 m	-	5,50	-	14,60	-	4,95	-	11,80	-	8,80	-	21,59
6,0 m	-	-	-	-	-	-	-	-	-	-	-	-
6,5 m	-	-	-	-	-	-	-	-	-	-	-	-
7,0 m	-	-	-	-	-	-	-	-	-	-	-	-
7,5 m	-	-	-	-	-	-	-	-	-	-	-	-

EMERGENCY LIGHT ALNAIR FOR THE ILLUMINATION OF CORRIDORS

- special lens for the illumination of escape routes or for area lighting
- plastic
- dimensions H x Ø: 28 x 78 mm
- single battery technology with LiFePO4 battery
- SK II / III with INSILIA technology
- 3h/8h bridging time



item	colour	colour temperature	price
565325	<input type="checkbox"/> white	<input checked="" type="checkbox"/> nw 4500 K	289,95 €

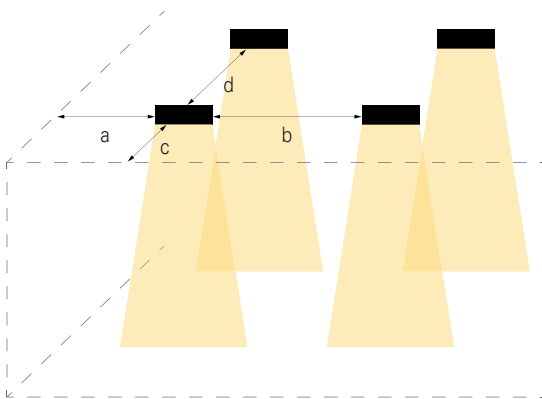

- a: distance from luminaire [narrow page] to wall
 b: distance from luminaire [narrow page] to luminaire [narrow page]
 c: distance from luminaire [long page] to wall
 d: distance from luminaire [long page] to luminaire [long page]



POWER RAILS

- 278 D ONE 1-phase power rail system
- 292 1-phase power rail luminaires
- 300 D LINE 3-phase power rail system
- 328 3-phase power rail luminaires





D ONE power rail system



D ONE MOUNTING POWER RAIL SYSTEM 1-PHASE 230V

mounting modules	illust.	white	black	page
mounting power rail L: 1000 mm	01	720000	720003	284
mounting power rail L: 2000 mm	01	720001	720004	284
mounting power rail L: 3000 mm	01	720002	720005	284
endcap	02	720030	720031	289
feeder left	03	720006	720007	285
feeder right	04	720008	720009	285
flex feeder with ceiling canopy	05	720010	720011	286
electrical straight connector with center feed option	06	720012	720013	287
electrical connector	07	720014	720015	287
90°-joint left	08	720016	720017	285
90°-joint right	09	720018	720019	285
T-joint left-right-right	10	720020	720021	285
T-joint right-right-left	11	720022	720023	285
T-joint left-left-right	12	720024	720025	285
T-joint right-left-left	13	720026	720027	285
X-joint left-left-right-right	14	720028	720029	289
ceiling mounting bracket flex	15	720032	720033	291
wire suspension bracket 3000 mm	16	720034	720035	291
1-phase adapter for light installation	17	720036	720037	290

ILLUSTRATIONS WITH PLANNING-RELEVANT DIMENSIONS

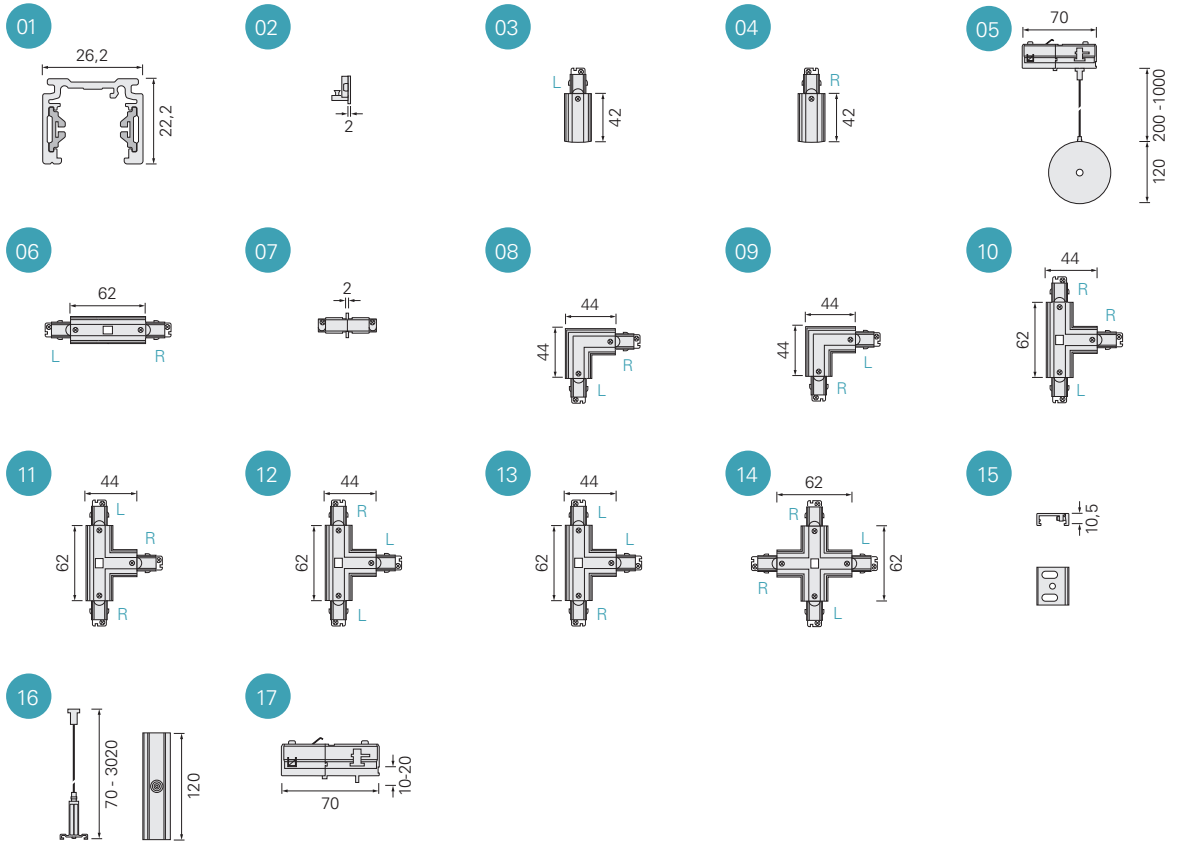

FIXING POINTS

power rail	a	b	c	d
1000 mm	125 mm			
2000 mm	125 mm	870 mm		
3000 mm	125 mm		790 mm	1160 mm

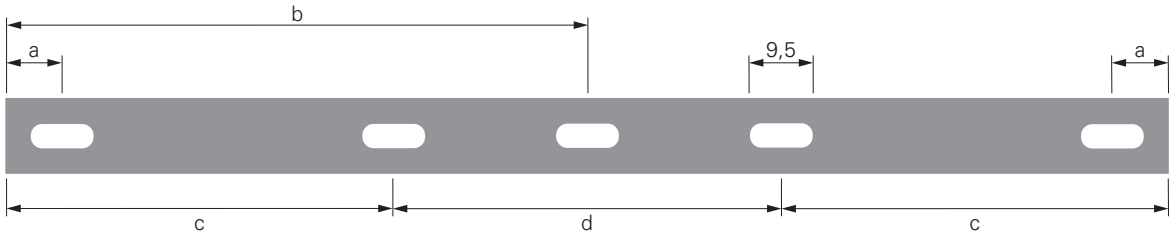

MECHANICAL LOAD TRACK POWER RAIL 1000 MM

50 N $\hat{=}$ 5,09 kg
dimension in mm

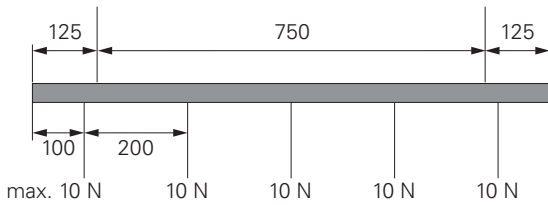

MECHANICAL LOAD TRACK POWER RAIL 2000MM

50 N $\hat{=}$ 5,09 kg
dimension in mm

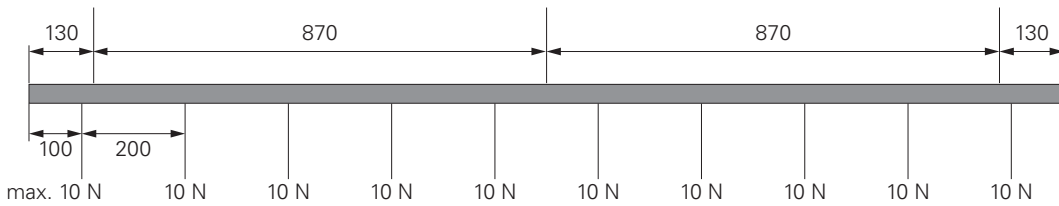

MECHANICAL LOAD TRACK POWER RAIL 3000MM

50 N $\hat{=}$ 5,09 kg
dimension in mm

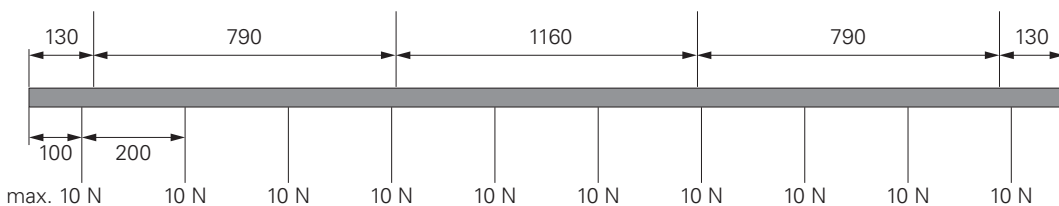

PLANNING GUIDE D ONE TRACK SYSTEM 1-PHASE 230V

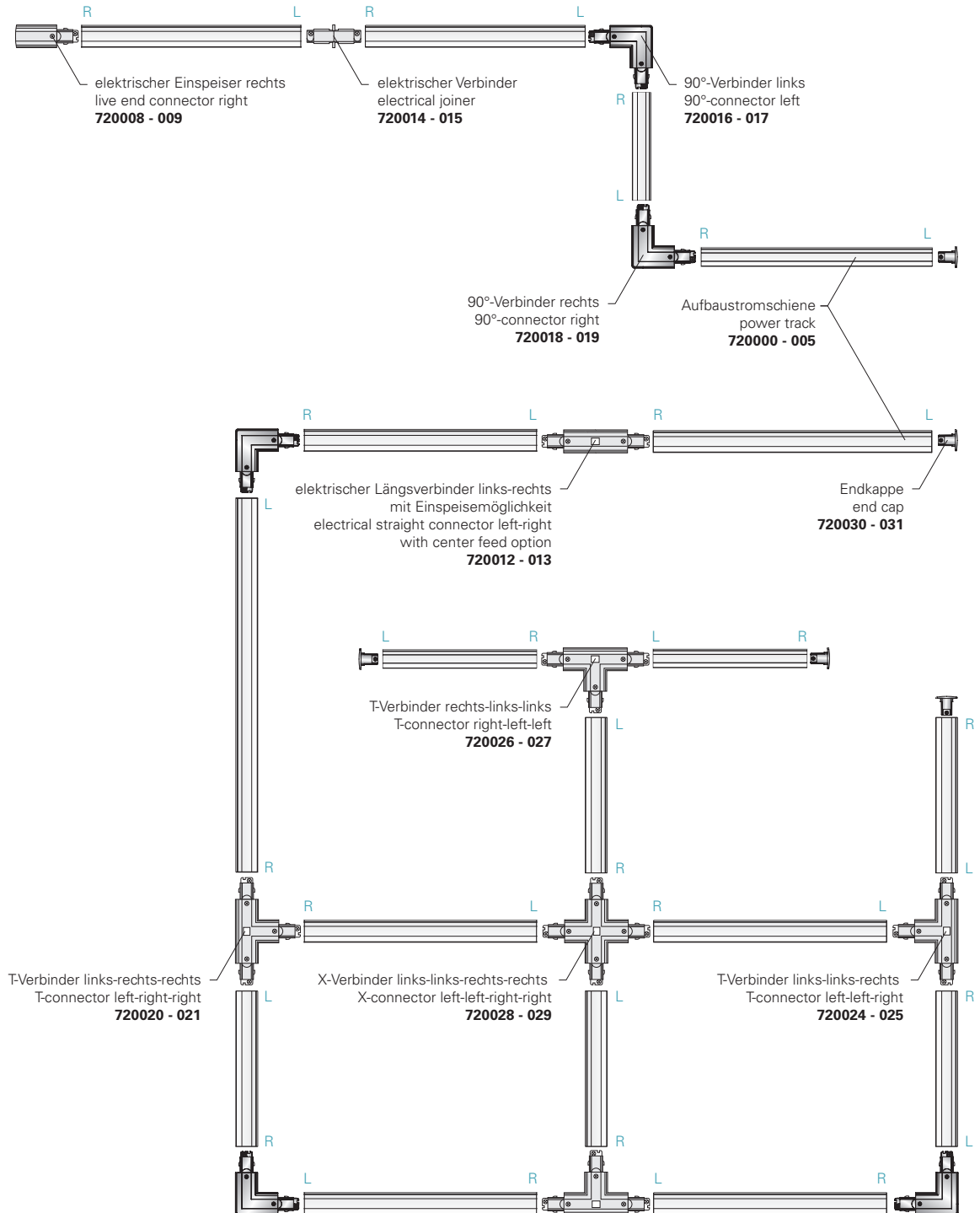
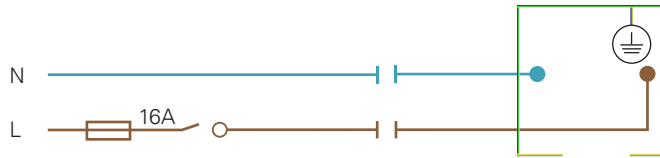
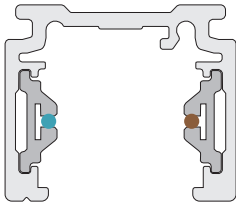

D LINE POWER RAIL SYSTEM 3-PHASE 230V

D ONE is the new 1-phase track system for 230V use and is now available exclusively at DEKO-LIGHT. The extremely compact and filigree system combines the advantages of 48V low-voltage tracks [slim design] with the practical benefits of established 230V systems [transformerless operation]. With their small dimensions, all D ONE components fit perfectly into a wide variety of interiors and give private living spaces and commercial interiors, such as shops and bars, a refined, discreet and timeless look.

All D ONE components are available in the universally suitable colours white and black and enable a wide variety of mounting options for flexible application use. Thanks to the new Flex feeder with ceiling canopy, the D ONE track system can be installed even if the power connection is not available in the immediate vicinity.



D ONE MOUNTING POWER RAIL

- aluminium
- 1-phase

item	colour	dimensions W x H x L	price
720000	<input type="checkbox"/> white	26,2 x 22,2 x 1000 mm	39,95 €
720001	<input type="checkbox"/> white	26,2 x 22,2 x 2000 mm	69,95 €
720002	<input type="checkbox"/> white	26,2 x 22,2 x 3000 mm	99,95 €
720003	<input checked="" type="checkbox"/> black	26,2 x 22,2 x 1000 mm	39,95 €
720004	<input checked="" type="checkbox"/> black	26,2 x 22,2 x 2000 mm	69,95 €
720005	<input checked="" type="checkbox"/> black	26,2 x 22,2 x 3000 mm	99,95 €





D ONE ELECTRIC FEEDER LEFT

- plastic
- power feed possible from above [ceiling] or from the side

item	colour	dimensions L x W x H	price
720006	<input type="checkbox"/> white	71 x 26 x 22,2 mm	13,95 €
720007	<input checked="" type="checkbox"/> black	71 x 26 x 22,2 mm	13,95 €

220-240 Volt	16 A	IP20
-----------------	------	------



D ONE ELECTRIC FEEDER RIGHT

- plastic
- power feed possible from above [ceiling] or from the side

item	colour	dimensions L x W x H	price
720008	<input type="checkbox"/> white	71 x 26 x 22,2 mm	13,95 €
720009	<input checked="" type="checkbox"/> black	71 x 26 x 22,2 mm	13,95 €

220-240 Volt	16 A	IP20
-----------------	------	------



D ONE FLEX FEEDER WITH CEILING CANOPY

- plastic/metal
- cable length between canopy and feeder 1000 mm
- max. 1320W connected power

item	colour	dimensions W x Ø	price
720010	<input type="checkbox"/> white	28 x 120 x 200-1000 mm	39,95 €
720011	<input checked="" type="checkbox"/> black	28 x 120 x 200-1000 mm	39,95 €

220-240
Volt

6 A

IP20



D ONE ELECTRICAL STRAIGHT CONNECTOR WITH CENTER FEED OPTION

• plastic

item	colour	dimensions L x W x H	price
720012	<input type="checkbox"/> white	121 x 26 x 22,2 mm	24,95 €
720013	<input checked="" type="checkbox"/> black	121 x 26 x 22,2 mm	24,95 €

220-240 Volt	16 A	IP20
-----------------	------	------



D ONE ELECTRICAL JOINT

• plastic

item	colour	dimensions L x W x H	price
720014	<input type="checkbox"/> white	62 x 26 x 22,2 mm	8,95 €
720015	<input checked="" type="checkbox"/> black	62 x 26 x 22,2 mm	8,95 €

220-240 Volt	16 A	IP20
-----------------	------	------

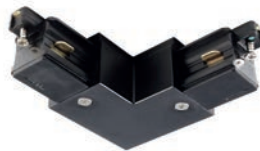

D ONE 90°-JOINT

- plastic
- power feed via ceiling possible

item	colour	alignment	dimensions L x W x H	price
720016	<input type="checkbox"/> white	left	73 x 73 x 22,2 mm	24,95 €
720017	<input checked="" type="checkbox"/> black	left	73 x 73 x 22,2 mm	24,95 €
720018	<input type="checkbox"/> white	right	73 x 73 x 22,2 mm	24,95 €
720019	<input checked="" type="checkbox"/> black	right	73 x 73 x 22,2 mm	24,95 €

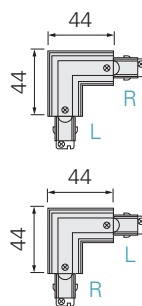

D ONET-JOINT

- plastic
- power feed via ceiling possible

item	colour	alignment	dimensions L x W x H	price
720020	<input type="checkbox"/> white	left-right-right	121 x 73 x 22,2 mm	34,95 €
720021	<input checked="" type="checkbox"/> black	left-right-right	121 x 73 x 22,2 mm	34,95 €
720022	<input type="checkbox"/> white	right-right-left	121 x 73 x 22,2 mm	34,95 €
720023	<input checked="" type="checkbox"/> black	right-right-left	121 x 73 x 22,2 mm	34,95 €
730024	<input type="checkbox"/> white	left-left-right	121 x 73 x 22,2 mm	34,95 €
720025	<input checked="" type="checkbox"/> black	left-left-right	121 x 73 x 22,2 mm	34,95 €
720026	<input type="checkbox"/> white	right-left-left	121 x 73 x 22,2 mm	34,95 €
720027	<input checked="" type="checkbox"/> black	right-left-left	121 x 73 x 22,2 mm	34,95 €

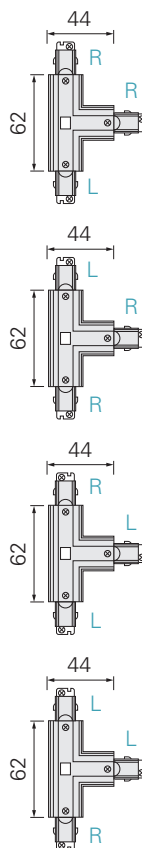
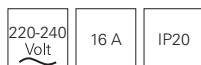



D ONE X-JOINT

- plastic
- power feed via ceiling possible

item	colour	alignment	dimensions L x W x H	price
720028	<input type="checkbox"/> white	left-left-right-right	121 x 121 x 22,2 mm	49,95 €
720029	<input checked="" type="checkbox"/> black	left-left-right-right	121 x 121 x 22,2 mm	49,95 €

220-240 Volt	16 A	IP20
-----------------	------	------

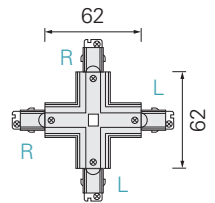

D ONE ENDCAP

- plastic

item	colour	dimensions L x W x H	price
720030	<input type="checkbox"/> white	15 x 26 x 22,2 mm	3,95 €
720031	<input checked="" type="checkbox"/> black	15 x 26 x 22,2 mm	3,95 €



D ONE 1-PHASE-ADAPTER FOR LUMINAIRE MOUNTING

- plastic / metal
- max. 10 kg/100N
- delivery includes trumpet nipple and M10 flat nut and strain relief grommet
- luminaire not included

item	colour	dimensions L x W x H	price
720036	<input type="checkbox"/> white	70 x 26 x 30 mm	16,95 €
720037	<input checked="" type="checkbox"/> black	70 x 26 x 30 mm	16,95 €



220-250 Volt	6 A	IP20
-----------------	-----	------



D ONE MOUNTING BRACKET FLEX

- metal
- simplifies the assembly of more complex power rail layouts

item	colour	dimensions L x W x H	price
720032	□ white	30 x 28 x 10,5 mm	5,95 €
720033	■ black	30 x 28 x 10,5 mm	5,95 €



D ONE ROPE SUSPENSION BRACKET MINI

- metal
- elegantly shaped and filigree suspension
- rope length: 3000 mm
- suspension dimension can be individually shortened: 70 - 3020 mm

item	colour	dimensions L x W x H	price
720034	□ white	120 x 28 x 70-3020 mm	19,95 €
720035	■ black	120 x 28 x 70-3020 mm	19,95 €





□ ■ □
page 294



□ ■ □
page 295



□ ■
page 296



□ ■
page 297



□ ■
page 298



□ ■
page 299

1-phase power rail luminaires

LUCEA

For the 1-phase 230V track system, we offer the spotlights of the LUCEA series. In the version as a ceiling luminaire, they are available with 6 and 10 watts, enabling a maximum light output of up to 3000 lumens.



suitable
pendant lights
from page 26
342177-342182

LUCEA 6 + 10

- dimmable via phase cut-in or phase cut-out
- rotatable and swivelling
- aluminium diecast
- dimensions H x Ø: 249 x 65 mm

item	colour	colour temperature	light current	power	price
707165	white	ww 2700 K	600 lm	6 W	84,95 €
707166	black	ww 2700 K	600 lm	6 W	84,95 €
707167	white	ww 2700 K	1000 lm	10 W	89,95 €
707168	black	ww 2700 K	1000 lm	10 W	89,95 €



suitable
ceiling surface-
mounted lamps
from page 83
348153-348160
348161-348168

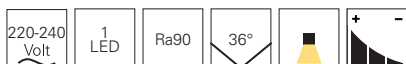

accessories

930679	lens 24° for LUCEA 6/10	9,95 €
930752	barn door for LUCEA 6/10 white	22,95 €
930753	barn door for LUCEA 6/10 black	22,95 €
930756	reflector ring for LUCEA 6/10 white	4,95 €
930757	reflector ring for LUCEA 6/10 black	4,95 €
930758	reflector ring for LUCEA 6/10 gold	4,95 €

LUCEA

The matching pendant luminaires of the LUCEA series for the 1-phase 230V track system are available in the versions 6 and 10 watts and offer up to 2000 lumens of light output. The maximum suspension is 1800 mm.



suitable
pendant lights
from page 26
342177-342182

LUCEA 6 + 10

- dimmable via phase cut-in or phase cut-out
- max. suspension 1800 mm
- aluminium diecast
- dimensions H x Ø: 157 x 65 mm

item	colour	colour temperature	light current	power	price
707175	white	2700 K	600 lm	6 W	114,95 €
707176	black	2700 K	600 lm	6 W	114,95 €
707177	white	2700 K	1000 lm	10 W	119,95 €
707178	black	2700 K	1000 lm	10 W	119,95 €



suitable
ceiling surface-
mounted lamps
from page 83
348153-348160
348161-348168



accessories

930679	lens 24° for LUCEA 6/10	9,95 €
930752	barn door for LUCEA 6/10 white	22,95 €
930753	barn door for LUCEA 6/10 black	22,95 €
930756	reflector ring for LUCEA 6/10 white	4,95 €
930757	reflector ring for LUCEA 6/10 black	4,95 €
930758	reflector ring for LUCEA 6/10 gold	4,95 €

SLIM

For the track system, we offer matching pendant luminaires of the SLIM series. The luminaire body made of aluminium diecast is always the same size [300 x 39mm]. The pendant luminaires for the tracks allow a maximum suspension of 1800 mm.

This makes the one-lamp SLIM track luminaires particularly suitable for restaurant and retail projects with changing room layouts. The quality of the SLIM series is rounded off by a flexible textile cable.



SLIM

- extra soft textile cable
- glare-free, thanks to low UGR value [<19]
- slim design with only 39 mm diameter
- aluminium diecast
- dimensions H x \varnothing : 300 x 39 mm
- max. suspension: 1800 mm
- dimmable via phase cut-in or phase cut-out



suitable
pendant lights
from page 29
342213-342218
342237-342242

item	colour	colour temperature	light current	price
707164	white	ww 2700 K	500 lm	89,95 €
707163	black	ww 2700 K	500 lm	89,95 €



accessories

930747	lens 15°	4,95 €
930748	lens 36°	4,95 €
930749	lens 60°	4,95 €
930744	reflector ring white	4,95 €
930745	reflector ring black	4,95 €
930746	reflector ring gold	5,95 €



CAN

- aluminium diecast
- dimensions L x Ø: 134 x 60 mm
- dimmable with optional light source

item	colour	price
707155	□ white	39,95 €
707156	■ black	39,95 €



accessories

930301	reflector ring H: 28 mm white	4,95 €
930302	reflector ring H: 28 mm black	4,95 €
930303	reflector ring H: 28 mm gold optics mat	4,95 €
930366	reflector ring H: 28 mm silver coloured	4,95 €

suitable illuminants on page 800-801



Foto: Daniel Wieser | Architekt | Fotografien Karlsruhe

NIHAL MINI

- rotatable and swivelling
- high tilt angle
- aluminium diecast
- dimensions L x W x H x Ø: 94 x 102 x 139 x 60 mm
- total power consumption: 8,9 W
- dimmable via phase cut-in or phase cut-out

item	colour	colour temperature	light current	price
707185	white	ww 2700 K	lm	144,95 €
707186	black	ww 2700 K	lm	144,95 €

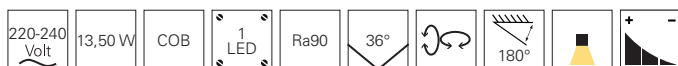

accessories

930297	side cover white	3,95 €
930298	side cover black	3,95 €
930364	side cover silver	3,95 €
930299	side cover gold	3,95 €
930300	side cover walnut look	5,95 €
930768	side cover oak wood look natural	5,95 €
930301	reflector ring white	4,95 €
930302	reflector ring black	4,95 €
930303	reflector ring gold	4,95 €
930366	reflector ring silver	4,95 €
930765	reflector 24°	10,95 €
930305	reflector 36°	3,60 €
930306	reflector 48°	8,95 €
930307	honeycomb filter	8,95 €
930308	Spread Lens	10,95 €
930309	Softening Lens	10,95 €
930310	Linear Spread Lens	10,95 €
930767	Lens 12°	10,95 €



UNI II MINI

- rotatable and swivelling
- dimmable via phase cut-in or phase cut-out
- aluminium diecast
- dimensions T x H x Ø: 160 x 75 x 91 mm
- total power consumption: 8,9 W

item	colour	colour temperature	light current	price
707187	□ white	ww 2700 K	lm	129,95 €
707188	■ black	ww 2700 K	lm	129,95 €

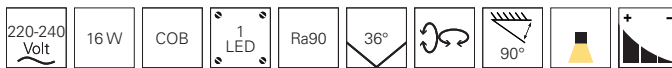

suitable
recessed ceiling
lights
page 139
565342
565354



suitable
surface-mounted
ceiling lights
page 75
348233
348234
348122
348178



accessories

930330	reflector ring white	10,95 €
930331	reflector ring black	10,95 €
930333	reflector ring chrome	10,95 €
930332	reflector ring gold	10,95 €
930381	reflector ring II black	10,95 €
930326	cover back white	3,55 €
930327	cover back black	3,45 €
930328	cover heat sink white	3,55 €
930329	cover heat sink black	2,95 €
930770	reflector 24°	10,95 €
930771	reflector 48°	10,95 €

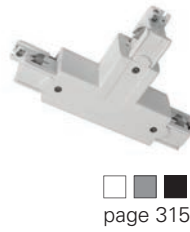
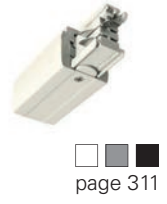



□ ■
page 325



□ ■ ■
page 326



□ ■ ■
page 326



□ ■ ■
page 327

D LINE power rail system

D LINE MOUNTING POWER RAIL SYSTEM 3-PHASE 230V

mounting modules	illust.	white	grey	black	page
mounting power rail L: 1000 mm	01	710000	710001	710002	309
mounting power rail L: 2000 mm	01	710003	710004	710005	309
mounting power rail L: 3000 mm	01	710006	710007	710008	309
mounting adapter for lights	02	710045	710046	710047	310
live end feeder left	03	710009	710010	710011	311
live end feeder right side	04	710012	710013	710014	311
electrical straight connector with center feed option	05	710042	710043	710044	312
flexible-connector left-right side	06	710039	710040	710041	312
electrical joint	07	710015	710016	710017	313
mechanical joint	08	710018	710019	710020	313
90°-joint left-right with exchange mechanism	09	710036	710037	710038	314
T-joint left-left-right with exchange mechanism	10	710027	710028	710029	315
T-joint right-right-left with exchange mechanism	11	710030	710031	710032	315
X-joint left-left-right-right	12	710033	710034	710035	316
cover plate built in track	13	710077	-	710079	317
endcap	14	710066	710067	710068	317
ceiling mounting bracket flex	15	710063	710064	710065	318
suspension clamp for track connection	16	710057	710058	710059	318
ceiling suspension rigid [635 mm] with canopy	17	710078	710085	710084	319
extension for ceiling suspension [300 mm]	17	710086	710088	710087	319
wire suspension bracket with ceiling rosette 1500 mm	18	710048	710049	710050	320
rope suspension bracket Mini mit Abhängeseil 5000 mm	19	710094	710095	710096	320
quick mounting bracket for grid ceilings	20	710051	710052	710053	323
truss adapter silver coloured	21	-	710083	-	321
quick mounting clamp for exhibition stand construction	22	-	-	710082	321
3-circuits adapter for light installation	23	710097	710098	710099	324
3-circuits adapter with Multi CC power supply 250/350/450/500 mA 6,30 - 21,00 W 25-42V	24	862180	-	862183	325
3-circuits adapter with Multi CC power supply 600/700/750/800 mA 15,00 - 33,60 W 25-42V	24	862181	-	862184	325
3-circuits adapter with Multi CC power supply 850/900/950/1050 mA 23,00 - 44,10 W 27-42V	24	862182	-	862185	325
electrical outlet adapter	25	710024	710025	710026	326
mounting adapter for additional components max. 10kg	26	710054	710055	710056	326
signs hook, max. load 5kg	27	710060	710061	710062	327

ILLUSTRATIONS WITH PLANNING RELEVANT DIMENSIONS

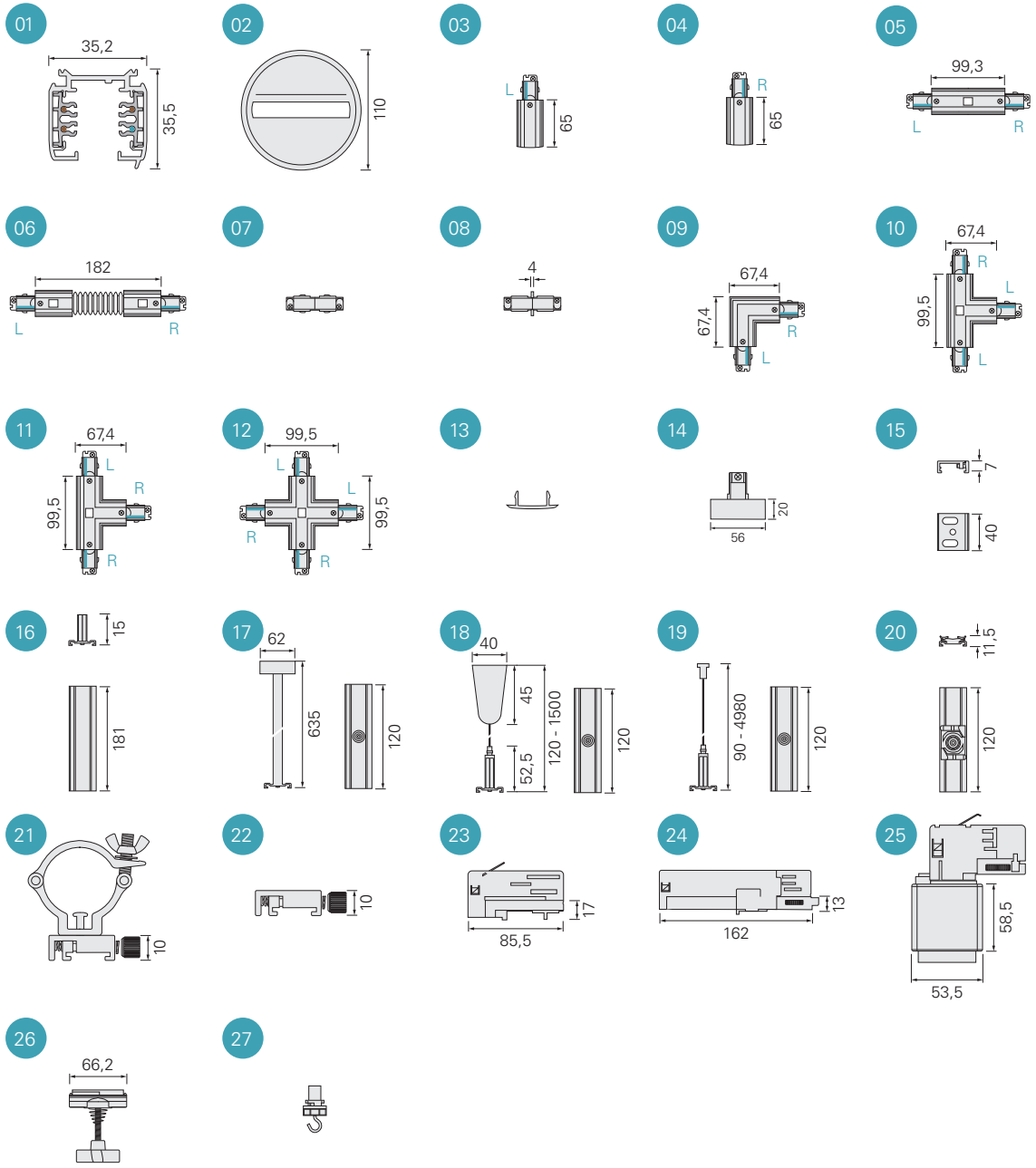

D LINE BUILT IN POWER RAIL SYSTEM 3-PHASE 230V

	illustr.	white	illustr.	cover	page
built in modules					
built in power rail L:1000 mm	01	710069		-	309
built in power rail L: 2000 mm	01	710070		-	309
built in power rail L: 3000 mm	01	710071		-	309
electric feeder left side	02	710009	18	710089	311
electric feeder right side	03	710012	18	710089	311
electrical straight connector with center feed option	04	710042	19	710090	312
electrical joint	05	710015		-	313
mechanical joint	06	710018		-	313
90°-joint left-right	07	710036	20	710091	314
T-joint left-left-right	08	710027	21	710093	315
T-joint right-right-left	09	710030	21	710093	315
X-joint left-left-right-right	10	710033	22	710092	316
cover plate built in track	11	710077			317
endcap	12	710103		-	317
3-circuits adapter for light installation	13	710097		-	324
3-circuits adapter with Multi CC power supply 250/350/450/500 mA 6,30 - 21,00 W 25-42V	14	862180			325
3-circuits adapter with Multi CC power supply 600/700/750/800 mA 15,00 - 33,60 W 25-42V	14	862181			325
3-circuits adapter with Multi CC power supply 850/900/950/1050 mA 23,00 - 44,10 W 27-42V	14	862182			325
electrical outlet adapter	15	710024		-	326
mounting adapter for additional components max. 10kg	16	710054		-	326
signs hook, max. load 5kg	17	710060		-	327



Unlike other systems, you will not need any additional or special electrical components such as feeders, connectors, corners or T-connectors for the recessed tracks in the future. All standard components of the system are used and only the matching plastic cover is exchanged, and the recessed version is ready. This simplifies stock-keeping and gives significantly more flexibility here as well.

ILLUSTRATIONS WITH PLANNING-WRELEVANT DIMENSIONS

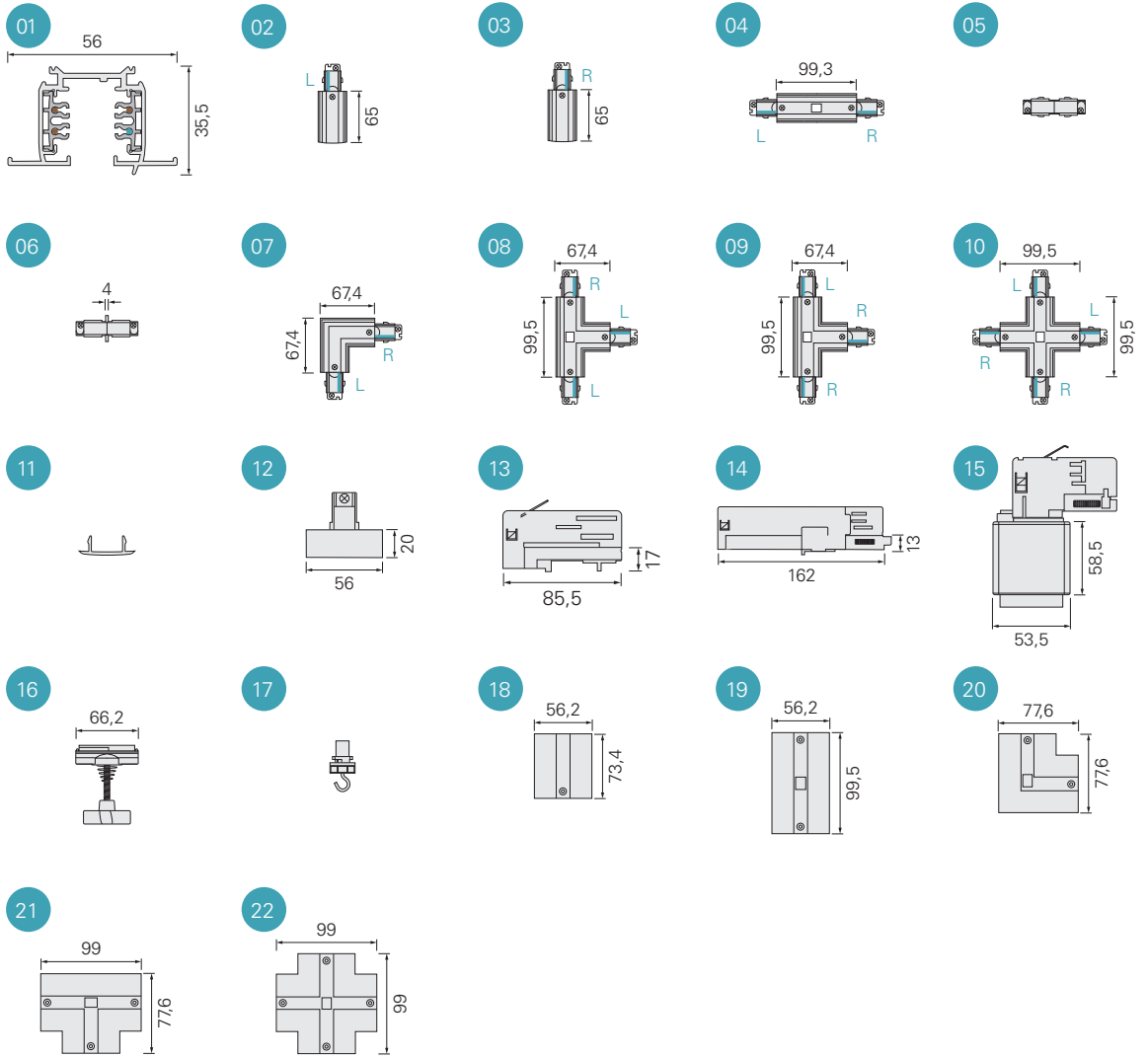

FIXING POINTS

power rail	a	b	c	d
1000 mm	125 mm			
2000 mm	125 mm	998 mm		
3000 mm	125 mm		914 mm	1167 mm

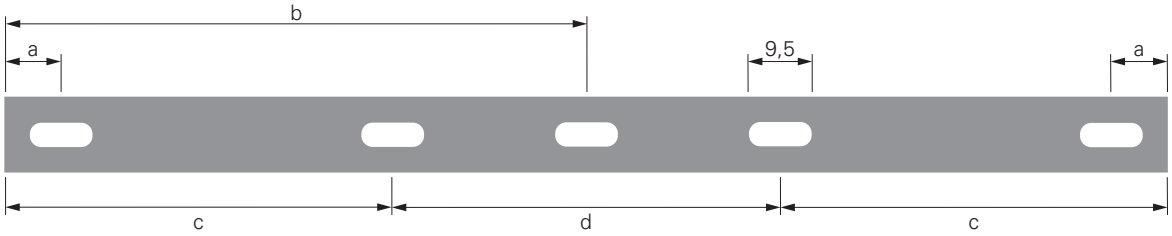

MECHANICAL LOAD TRACK POWER RAIL 1000 MM

50 N $\hat{=}$ 5,09 kg
dimension in mm

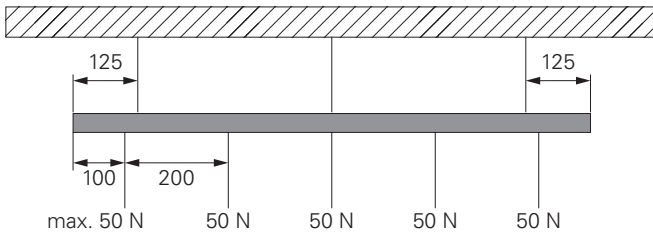

MECHANICAL LOAD TRACK POWER RAIL 2000/3000 MM

50 N $\hat{=}$ 5,09 kg
dimension in mm

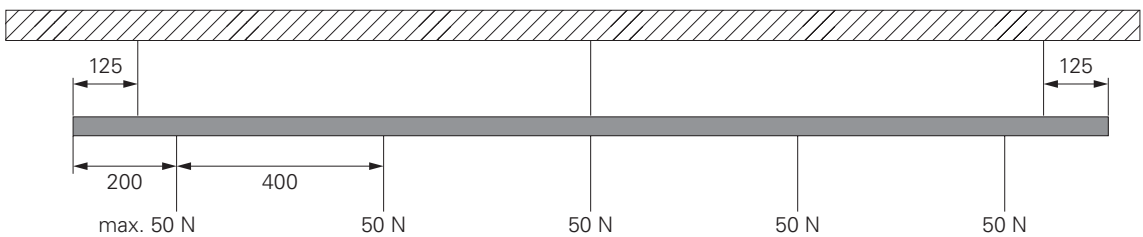

PLANNING GUIDE D LINE MOUNTING POWER RAIL SYSTEM 3-PHASE 230V

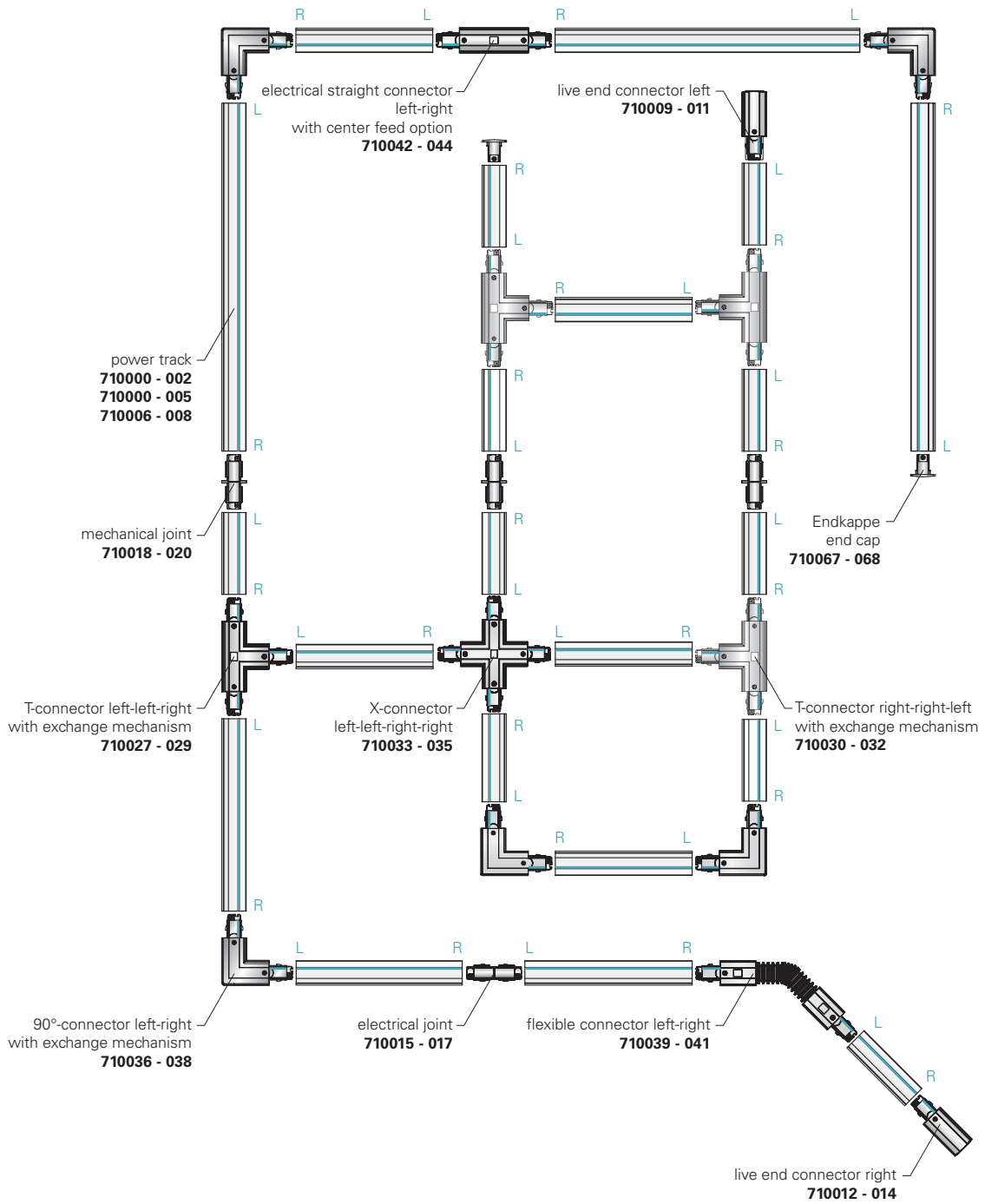
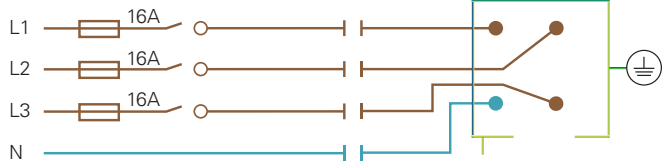
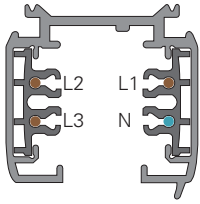

D LINE POWER RAIL SYSTEM 3-PHASE 230V

The new D LINE track system is available exclusively from DEKO-LIGHT and is extremely easy to plan and install thanks to its components, some of which have been completely redesigned. It is also compatible with all common track adapters and luminaires. The elegant and timeless design is available in white, black and grey, and the wide range

of accessories and mounting components means that there are no limits to its use and installation. Thanks to the new interchangeable mechanism of the 90° and T connectors, planning is easier than ever before and the installation of even complex shapes will be child's play in the future.

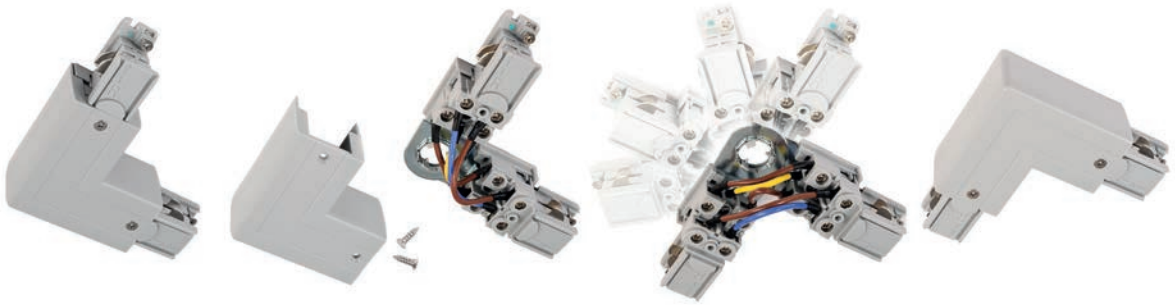

COMPATIBILITY OVERVIEW

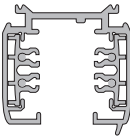
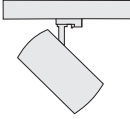
power rail D LINE	luminaires and power rail adapters from:						
	D LINE	Global	Ivela	Erco	Hoffmeister	Zumtobel/ Staff	Eutrac
	compatible	compatible	compatible	compatible	compatible	compatible	compatible
luminaires DEKO-LIGHT	3-phase power rail from:						
	D LINE	Global	Ivela	Erco	Hoffmeister	Zumtobel/ Staff	Eutrac
	compatible	compatible*	compatible*	compatible*	compatible*	compatible*	compatible*

*compatible with all DEKO-LIGHT 3-phase spotlights, except ALNITAK series [S. 333] and 3-phase adapter with integrated multi-CC power supply [S. 325].

All data without guarantee. Technical data and dimensions are subject to change without prior notice. Check against samples when planning a project to ensure functionality.



D LINE MOUNTING POWER RAIL

- aluminium
- 3-phase

item	colour	dimensions W x H x L	price
710000	<input type="checkbox"/> white	35,2 x 35,2 x 1000 mm	44,95 €
710003	<input type="checkbox"/> white	35,2 x 35,2 x 2000 mm	89,95 €
710006	<input type="checkbox"/> white	35,2 x 35,2 x 3000 mm	129,95 €
710001	<input type="checkbox"/> grey	35,2 x 35,2 x 1000 mm	44,95 €
710004	<input type="checkbox"/> grey	35,2 x 35,2 x 2000 mm	89,95 €
710007	<input type="checkbox"/> grey	35,2 x 35,2 x 3000 mm	129,95 €
710002	<input type="checkbox"/> black	35,2 x 35,2 x 1000 mm	44,95 €
710005	<input type="checkbox"/> black	35,2 x 35,2 x 2000 mm	89,95 €
710008	<input type="checkbox"/> black	35,2 x 35,2 x 3000 mm	129,95 €

220-240 Volt	16 A	IP20
-----------------	------	------

D LINE BUILT IN POWER RAIL WITH WINGS

- aluminium
- 3-phase

item	colour	dimensions W x H x L	price
710069	<input type="checkbox"/> white	56 x 35,5 x 1000 mm	54,95 €
710070	<input type="checkbox"/> white	56 x 35,5 x 2000 mm	99,95 €
710071	<input type="checkbox"/> white	56 x 35,5 x 3000 mm	144,95 €

220-240 Volt	16 A	IP20
-----------------	------	------



On request, all D LINE busbars can be supplied ready-made and cut to size according to your specifications for a small surcharge. This allows you to start installation directly on site at the customer's premises. Please contact our sales department for more information.



With the surface-mounted adapter, every 3-phase track luminaire can be converted into a surface-mounted spotlight. This is often desired when ceiling spots scattered around the room are to match the design of the track spotlights.



D LINE MOUNTING ADAPTER FOR LIGHTS

- plastic
- luminaire not included

item	colour	dimensions W x Ø	price
710045	<input type="checkbox"/> white	35 x 110 mm	29,95 €
710046	<input type="checkbox"/> grey	35 x 110 mm	29,95 €
710047	<input type="checkbox"/> black	35 x 110 mm	29,95 €

220-240
Volt

16 A

IP20



D LINE ELECTRIC FEEDER LEFT

- plastic
- suitable for mounting and built-in system
- power feed possible from above [ceiling] or from the side
- up to 3-phases can be fed in

item	colour	dimensions L x W x H	price
710009	<input type="checkbox"/> white	98,5 x 35,2 x 35,5 mm	15,95 €
710010	<input type="checkbox"/> grey	98,5 x 35,2 x 35,5 mm	15,95 €
710011	<input type="checkbox"/> black	98,5 x 35,2 x 35,5 mm	15,95 €

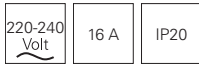
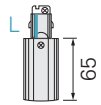

accessories for built in system

710089 cover plate built in track feeder left/right **3,95 €**



D LINE ELECTRIC FEEDER RIGHT

- plastic
- suitable for mounting and built-in system
- power feed possible from above [ceiling] or from the side
- up to 3-phases can be fed in

item	colour	dimensions L x W x H	price
710012	<input type="checkbox"/> white	98,5 x 35,2 x 35,5 mm	15,95 €
710013	<input type="checkbox"/> grey	98,5 x 35,2 x 35,5 mm	15,95 €
710014	<input type="checkbox"/> black	98,5 x 35,2 x 35,5 mm	15,95 €

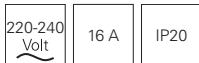
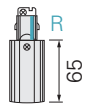

accessories for built in system

710089 cover plate built in track feeder left/right **3,95 €**





D LINE ELECTRICAL STRAIGHT CONNECTOR WITH CENTER FEED OPTION

- plastic
- suitable for mounting and built-in system
- up to 3-phases can be fed in

item	colour	dimensions L x W x H	price
710042	<input type="checkbox"/> white	166 x 35 x 35,5 mm	32,95 €
710043	<input type="checkbox"/> grey	166 x 35 x 35,5 mm	32,95 €
710044	<input type="checkbox"/> black	166 x 35 x 35,5 mm	32,95 €

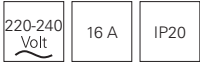

accessories for built in system

710090 cover plate built in track straight connector **3,95 €**



D LINE FLEXIBLE-CONNECTOR LEFT-RIGHT

- plastic
- suitable for mounting system

item	colour	dimensions L x W x H	price
710039	<input type="checkbox"/> white	248 x 35 x 35,5 mm	42,95 €
710040	<input type="checkbox"/> grey	248 x 35 x 35,5 mm	42,95 €
710041	<input type="checkbox"/> black	248 x 35 x 35,5 mm	42,95 €

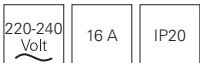



D LINE ELECTRICAL JOINT

- plastic
- suitable for mounting and built-in system

item	colour	dimensions L x W x H	price
710015	<input type="checkbox"/> white	68 x 20,5 x 26,5 mm	9,95 €
710016	<input type="checkbox"/> grey	68 x 20,5 x 26,5 mm	9,95 €
710017	<input type="checkbox"/> black	68 x 20,5 x 26,5 mm	9,95 €

220-240 Volt	16 A	IP20
-----------------	------	------



D LINE MECHANICAL JOINT

- plastic
- suitable for mounting and built-in system

item	colour	dimensions L x W x H	price
710018	<input type="checkbox"/> white	66,4 x 20 x 27 mm	6,95 €
710019	<input type="checkbox"/> grey	66,4 x 20 x 27 mm	6,95 €
710020	<input type="checkbox"/> black	66,4 x 20 x 27 mm	6,95 €

220-240 Volt	16 A	IP20
-----------------	------	------

If, for example, more complex track installations are to be visually connected to one piece, but several different power supplies/controls are used, the mechanical connector is ideal. Visually, the track appears to be in one piece, electrically the two sections are separated from each other.



D LINE 90°-JOINT LEFT-RIGHT WITH EXCHANGE MECHANISM

- plastic
- suitable for mounting and built-in system

item	colour	dimensions L x W x H	price
710036	white	100,7 x 100,7 x 35,5 mm	34,95 €
710037	grey	100,7 x 100,7 x 35,5 mm	34,95 €
710038	black	100,7 x 100,7 x 35,5 mm	34,95 €

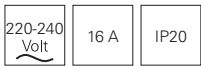
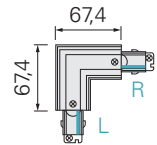

accessories for built in system

710091	cover plate built in track 90°-joint	3,95 €
---------------	--------------------------------------	---------------

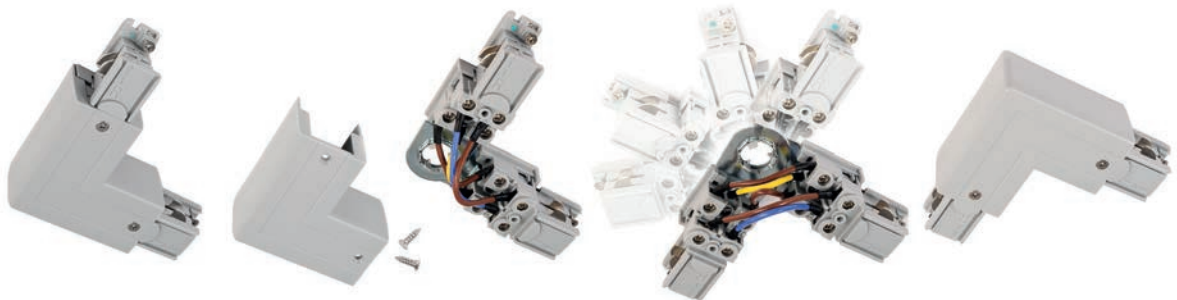

By simply removing the cover of the corner connector, the alignment [left/right] can be reversed. This eliminates the annoying rethinking [N conductor left or right] and makes both planning and installation child's play.

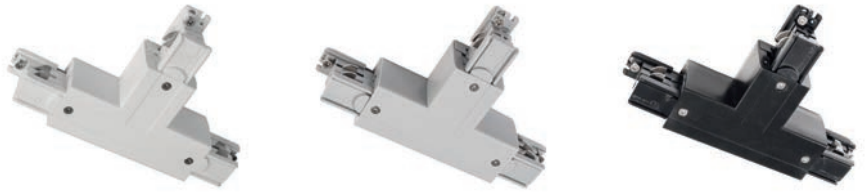

D LINE T-JOINT LEFT-LEFT-RIGHT WITH EXCHANGE MECHANISM

- plastic
- suitable for mounting and built-in system

item	colour	dimensions L x W x H	price
710027	white	166 x 101 x 35,5 mm	49,95 €
710028	grey	166 x 101 x 35,5 mm	49,95 €
710029	black	166 x 101 x 35,5 mm	49,95 €

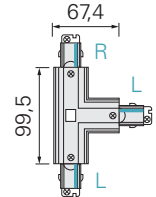

220-240 Volt	16 A	IP20
-----------------	------	------

D LINE T-JOINT RIGHT-RIGHT-LEFT WITH EXCHANGE MECHANISM

- plastic
- suitable for mounting and built-in system

item	colour	dimensions L x W x H	price
710030	white	166 x 101 x 35,5 mm	49,95 €
710031	grey	166 x 101 x 35,5 mm	49,95 €
710032	black	166 x 101 x 35,5 mm	49,95 €

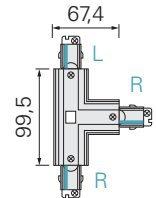

220-240 Volt	16 A	IP20
-----------------	------	------

accessories for built in system

710093	cover plate built in track T-joint	3,95 €
---------------	------------------------------------	---------------

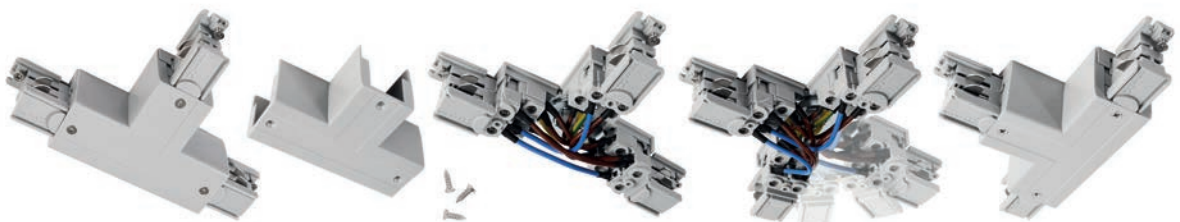

Almost identically to the corner connector, the direction [left/right] of the T-joint can also be changed by removing the cover. Due to the design, however, there are two T-joints in each colour variant, as it may be that either left/left/right or right/right/left is required depending on the alignment.

But also with this article, the variants could be reduced by half. This also means here: significantly simplified planning and assembly.

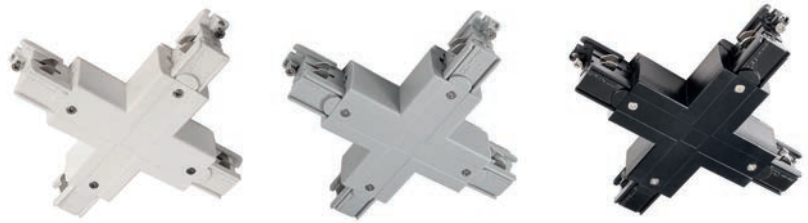

D LINE X-JOINT LEFT-LEFT-RIGHT-RIGHT

- plastic
- suitable for mounting and built-in system

item	colour	dimensions L x W x H	price
710033	white	166 x 166 x 35,5 mm	66,95 €
710034	grey	166 x 166 x 35,5 mm	66,95 €
710035	black	166 x 166 x 35,5 mm	66,95 €

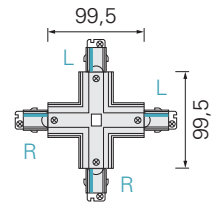

accessories for built in system

710092 cover plate built in track X-joint **4,95 €**



with the kind support of Salvia Elektrotechnik GmbH



D LINE COVER PLATE BUILT IN TRACK

- plastic
- suitable for mounting and built-in system

item	colour	dimensions L x W x H	price
710077	<input type="checkbox"/> white	1000 x 21,5 x 7,5 mm	5,95 €
710079	<input checked="" type="checkbox"/> black	1000 x 21,5 x 7,5 mm	5,95 €

Conductor rails mounted within a possible contact zone or at a height of less than 2.30 m must additionally be closed with a cover panel.



D LINE ENDCAP

- plastic

item	colour	suitable for	dimensions L x W x H	price
710066	<input type="checkbox"/> white	mounting system	31,3 x 35,2 x 32,5 mm	2,95 €
710067	<input checked="" type="checkbox"/> grey	mounting system	31,3 x 35,2 x 32,5 mm	2,95 €
710068	<input checked="" type="checkbox"/> black	mounting system	31,3 x 35,2 x 32,5 mm	2,95 €
710103	<input type="checkbox"/> white	built in system	56,0 x 47,9 x 32,5 mm	2,95 €



D LINE MOUNTING BRACKET FLEX

- metal
- suitable for mounting system

item	colour	dimensions L x W x H	price
710063	white	40 x 33,8 x 12,5 mm	5,95 €
710064	grey	40 x 33,8 x 12,5 mm	5,95 €
710065	black	40 x 33,8 x 12,5 mm	5,95 €



D LINE SUSPENSION CLAMP FOR TRACK CONNECTION

- metal
- suitable for mounting system
- for chain assembly
[chain not included]

item	colour	dimensions L x W x H	price
710057	white	181 x 32 x 20 mm	9,95 €
710058	grey	181 x 32 x 20 mm	9,95 €
710059	black	181 x 32 x 20 mm	9,95 €



D LINE CEILING SUSPENSION RIGID

- metal
- stable and shapely suspension
- suspension dimension 635 mm [can be shortened to 335 mm]
- suspension dimension can be extended by means of accessories
- suitable for mounting system



item	colour	dimensions L x W	price
710078	<input type="checkbox"/> white	635 x 60 mm	32,95 €
710085	<input type="checkbox"/> grey	635 x 60 mm	32,95 €
710084	<input type="checkbox"/> black	635 x 60 mm	32,95 €



EXTENSION FOR CEILING SUSPENSION

- metal
- increases the suspension dimension by 300 mm each
- suitable for rigid ceiling suspension

item	colour	dimensions L x W	price
710086	<input type="checkbox"/> white	300 x 10 mm	5,95 €
710088	<input type="checkbox"/> grey	300 x 10 mm	5,95 €
710087	<input type="checkbox"/> black	300 x 10 mm	5,95 €



D LINE WIRE SUSPENSION BRACKET

- metal / plastic
- rope length: 1500 mm
- suspension dimension can be individually shortened: 120-1500 mm
- suitable for mounting system

item	colour	dimensions L x W x H	price
710048	<input type="checkbox"/> white	120 x 31 x 52 mm	14,95 €
710049	<input type="checkbox"/> grey	120 x 31 x 52 mm	14,95 €
710050	<input type="checkbox"/> black	120 x 31 x 52 mm	14,95 €

accessories

710081	rope L: 4000 mm	7,95 €
---------------	-------------------	---------------

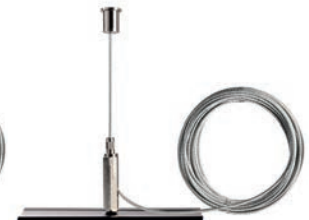
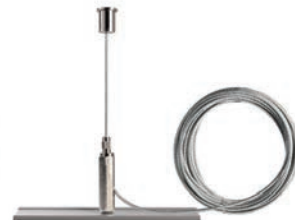

D LINE ROPE SUSPENSION BRACKET MINI

- metal
- beautifully shaped and filigree suspension
- rope length: 5000 mm
- suspension dimension can be individually shortened: 90 - 4980 mm
- suitable for mounting system

item	colour	dimensions L x W x H	price
710094	<input type="checkbox"/> white	120 x 31 x 58 mm	19,95 €
710095	<input type="checkbox"/> grey	120 x 31 x 58 mm	19,95 €
710096	<input type="checkbox"/> black	120 x 31 x 58 mm	19,95 €





D LINE QUICK MOUNTING CLAMP FOR TRADE FAIR CONSTRUCTION

- aluminium
- suitable for mounting system

item	colour	dimensions L x W x H	price
710082	■ black	40 x 30 x 11,9 mm	10,95 €

Especially in trade fair construction, where busbars are frequently mounted and dismantled, the quick mounting clamp is the perfect mounting aid. The conductor rail is clicked into place with the spring clip and fixed in place without tools by means of a knurled screw. Conductor rail installation has never been faster.

D LINE TRUSS ADAPTER

- aluminium
- suitable for mounting system

item	colour	dimensions L x W x H	price
710083	□ silver coloured	40 x 30 x 11,9 mm	29,95 €

Thanks to the quick-release fasteners of the truss adapter, the D LINE busbars can be mounted in seconds on the trusses with 50 mm tube diameters commonly used in event technology and exhibition stand construction.





This little »jack-of-all-trades« makes mounting a track on an existing grid ceiling child's play. The installation time is only a fraction of what it used to be. In the first step, the clip is simply clicked into the visible metal strips of the grid ceiling and is held bomb-proof on the ceiling by means of a safety spring clip. After that, the conductor rail is simply pushed onto it and the installation is finished.





D LINE QUICK MOUNTING BRACKET FOR GRID CEILINGS

- metal
- suitable for mounting system

item	colour	dimensions L x W x H	price
710051	<input type="checkbox"/> white	120 x 31 x 11 mm	11,95 €
710052	<input type="checkbox"/> grey	120 x 31 x 11 mm	11,95 €
710053	<input type="checkbox"/> black	120 x 31 x 11 mm	11,95 €





D LINE 3-PHASE-ADAPTER FOR LUMINAIRE MOUNTING

- plastic / metal
- max. 10 kg/100N
- secondary fall protection integrated
- suitable for mounting and built-in system
- delivery includes trumpet nipple and M10 flat nut and strain relief grommet
- luminaire not included



item	colour	dimensions L x W x H	price
710097	<input type="checkbox"/> white	84 x 32 x 54 mm	18,95 €
710098	<input type="checkbox"/> grey	84 x 32 x 54 mm	18,95 €
710099	<input type="checkbox"/> black	84 x 32 x 54 mm	18,95 €



220-250 Volt	10 A	IP20
-----------------	------	------

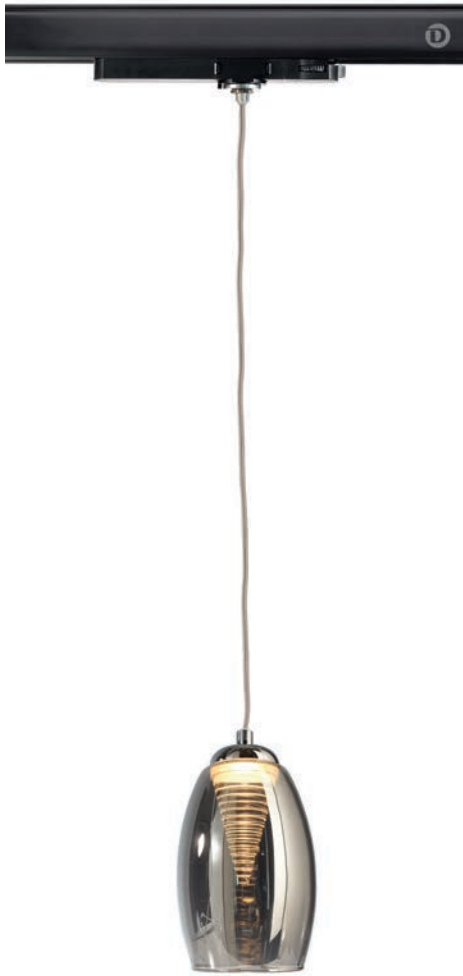

D LINE 3-PHASE-ADAPTER WITH MULTI CC POWER SUPPLY

- plastic / metal
- max. 10 kg/100N
- secondary fall protection integrated
- suitable for mounting and built-in system
- delivery includes trumpet nipple and M10 flat nut
- luminaire not included
- integrated, adjustable, current-stable power supply [CC]
- exclusively for 3-phase power rail from D LINE, Ivela and Hoffmeister
- it is essential to check suitability of the intended luminaire



item	colour	dimensions L x W x H	price
862180	<input type="checkbox"/> white	162 x 31 x 41 mm 250/350/450/500 mA 6,30 - 21,00 W 25-42V	32,95 €
862181	<input type="checkbox"/> white	162 x 31 x 41 mm 600/700/750/800 mA 15,00 - 33,60 W 25-42V	35,95 €
862182	<input type="checkbox"/> white	162 x 31 x 41 mm 850/900/950/1050 mA 23,00 - 44,10 W 27-42V	37,95 €
862183	<input checked="" type="checkbox"/> black	162 x 31 x 41 mm 250/350/450/500 mA 6,30 - 21,00 W 25-42V	32,95 €
862184	<input checked="" type="checkbox"/> black	162 x 31 x 41 mm 600/700/750/800 mA 15,00 - 33,60 W 25-42V	35,95 €
862185	<input checked="" type="checkbox"/> black	162 x 31 x 41 mm 850/900/950/1050 mA 23,00 - 44,10 W 27-42V	37,95 €





D LINE ELECTRICAL OUTLET ADAPTER

- plastic
- integrated fuse
- suitable for mounting and built-in system

item	colour	dimensions L x W x H	price
710024	white	58,5 x 53,5 x 103 mm	28,95 €
710025	grey	58,5 x 53,5 x 103 mm	28,95 €
710026	black	58,5 x 53,5 x 103 mm	28,95 €



D LINE MOUNTING ADAPTER FOR ADDITIONAL COMPONENTS

- plastic / metal
- max. load 10 kg/100N
- suitable for mounting and built-in system

item	colour	dimensions L x W x H	price
710054	white	66,5 x 31,5 x 84 mm	10,95 €
710055	grey	66,5 x 31,5 x 84 mm	10,95 €
710056	black	66,5 x 31,5 x 84 mm	10,95 €



With our socket adapter, additional devices, lights etc. can be supplied with power in the simplest way. In combination with the »Mounting adapter for additional components« [710054/55/56], additional headlights or other devices [up to 10kg] can be attached and supplied with power.



D LINE SIGNS HOOK

- plastic / metal
- max. load 5 kg/50N
- suitable for mounting and built-in system

item	colour	dimensions H x Ø	price
710060	<input type="checkbox"/> white	52 x 25 mm	2,95 €
710061	<input type="checkbox"/> grey	52 x 25 mm	2,95 €
710062	<input type="checkbox"/> black	52 x 25 mm	2,95 €



□ ■
page 331



□ □
page 331



□ □
page 332



□ □ ■
page 333



□ ■ □
page 335



□ ■ □
page 336



□ □ ■
page 337



□ ■ □
page 338



□ ■
page 339



□ □ ■
page 340



□ □ ■
page 341



□ □
page 342



□ □
page 343



□ ■ □
from page 344



□ ■ □
page 348



□ ■ □
page 351



□ ■
page 352



□ ■
page 353



3-phases power luminaires

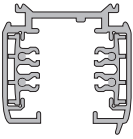

COMPATIBILITY OVERVIEW

power rail D LINE	luminaires and power rail adapters from:						
	D LINE	Global	Ivela	Erco	Hoffmeister	Zumtobel/ Staff	Eutrac
	compatible	compatible	compatible	compatible	compatible	compatible	compatible

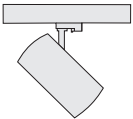
luminaires DEKO-LIGHT	3-phase power rail from:						
	D LINE	Global	Ivela	Erco	Hoffmeister	Zumtobel/ Staff	Eutrac
	compatible	compatible*	compatible*	compatible*	compatible*	compatible*	compatible*

*compatible with all DEKO-LIGHT 3-phase spotlights, except ALNITAK series [S. 333] and 3-phase adapter with integrated multi-CC power supply [S. 325].

All data without guarantee. Technical data and dimensions are subject to change without prior notice. Check against samples when planning a project to ensure functionality.



With the kind support of SH-Lichttechnik / Becks Reutlingen



PANEL TRACK LIGHT

- aluminium
- dimensions L x W x H: 300 x 110 x 8,5 mm

item	colour	colour temperature	light current	price
707134	□ white	www 3000 K	2000 lm	109,95 €
707136	□ white	nww 4000 K	2200 lm	109,95 €
707135	■ black	www 3000 K	2000 lm	109,95 €
707137	■ black	nww 4000 K	2200 lm	109,95 €

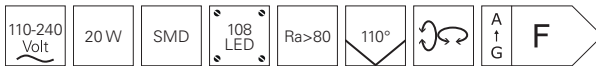

FLOOD SMD 15 + 30

- housing made of durable die-cast aluminium and glass
- large tilt angle
- rotatable and tiltable

suitable
floodlights
from page 504
732147-732155

item	colour	colour temperature	light current	dimensions L x W x H	socket L x W	power	light source	EEL	price
707130	□ white	www 3000 K	1575 lm	192 x 180 x 38 mm	179 x 20 mm	15 W	36 LED	E	99,95 €
707138	□ white	nww 4000 K	1650 lm	192 x 180 x 38 mm	179 x 20 mm	15 W	36 LED	E	99,95 €
707139	□ white	www 3000 K	3150 lm	261 x 236 x 41 mm	237 x 25 mm	30 W	72 LED	F	139,95 €
707140	□ white	nww 4000 K	3300 lm	261 x 236 x 41 mm	237 x 25 mm	30 W	72 LED	F	139,95 €





DRACONIS

- light colour and output adjustable via dip switch
- high luminous intensity [bis 8200 lm]
- aluminium diecast
- dimensions L x W x H: 578 x 189 x 129 mm
- socket L x W x H: 102 x 88 x 25 mm
- luminous flux at 2700 K:
72 W = 7330 lm / 55 W = 6000 lm / 45 W = 5030 lm
- luminous flux at 3000 K:
72 W = 8210 lm / 55 W = 6590 lm / 45 W = 5560 lm
- luminous flux at 4000 K:
72 W = 8250 lm / 55 W = 6950 lm / 45 W = 5700 lm

item	colour	colour temperature	price
620120	<input type="checkbox"/> white	WW NW 2700 / 3500 / 4000 K	349,95 €
620119	<input type="checkbox"/> aluminium	WW NW 2700 / 3500 / 4000 K	349,95 €



suitable
ceiling lights
page 81
348128
348099

accessories

- 930577** 15° lens asymmetric | 6 lenses installed per luminaire **9,95 €**
- 930544** 20° lens symmetrisch | 6 lenses installed per luminaire **9,95 €**
- 930545** 30° lens symmetrisch | 6 lenses installed per luminaire **9,95 €**
- 930546** 90° lens symmetrisch | 6 lenses installed per luminaire **9,95 €**

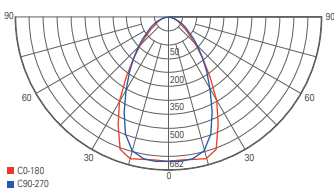
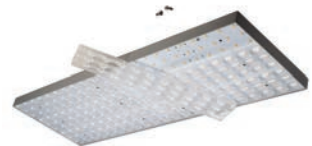

light distribution curve 620119 - 45 W

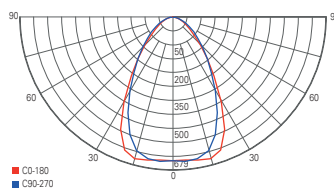

light distribution curve 620119 - 55 W

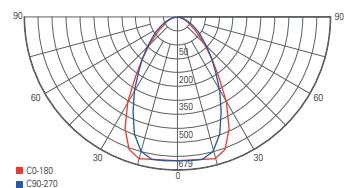







light distribution curve 620119 - 72 W



ALNITAK 25-34W

- aluminium
- dimensions L x W x H: 336 x 36 x 49 mm
- power: 25-34 W adjustable via dip switch
- UGR < 16
- exclusively for 3-phase power rails from D LINE, Ivela and Hoffmeister

item	colour	colour temperature	light current	price
707110	<input type="checkbox"/> white	 3000 K	3114 lm	169,95 €
707111	<input type="checkbox"/> white	 4000 K	3068 lm	169,95 €
707112	<input type="checkbox"/> silver coloured	 3000 K	3114 lm	169,95 €
707113	<input type="checkbox"/> silver coloured	 4000 K	3068 lm	169,95 €
707114	<input checked="" type="checkbox"/> black	 3000 K	3114 lm	169,95 €
707115	<input checked="" type="checkbox"/> black	 4000 K	3068 lm	169,95 €

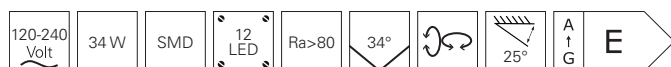

accessories

930386	reflector 12° silver coloured	1,95 €
930387	reflector 48° silver coloured	1,95 €
930388	Anti Glare white	2,95 €

LINEAR PRO TILT

The LINEAR PRO TILT 3-phase track luminaire is the ideal solution for the illumination of retail shelves. This luminaire offers a perfect combination of functionality and versatility. It can be locked in a downwards position or tilted by up to 30° to either side to direct the light precisely. Thanks to its BEG eligibility, you can benefit from financial advantages. With a long service life of 60,000 hours [L80B50], this luminaire is a long-term investment. The output is adjustable in three steps [except for the DALI models] to optimally adapt the illumination to the requirements. The 1500 mm versions have a sliding track adapter and are each available in 50% mirrored A/B versions for seamless alignment even across track connectors. The LINEAR PRO TILT track luminaire - professional lighting for retail shelving with maximum flexibility.

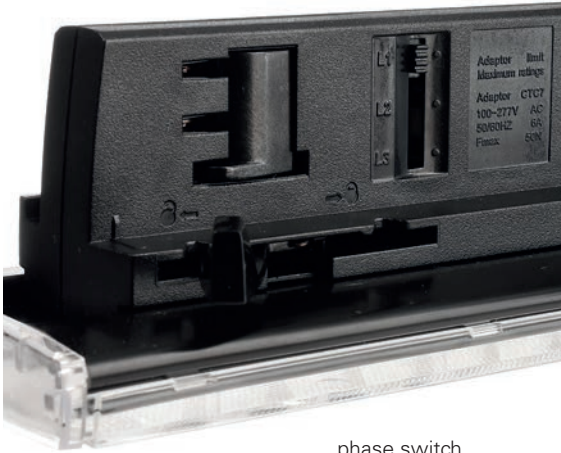

phase switch



dip switch





LINEAR PRO TILT

- BEG eligible
- lockable downwards
- swivels up to 30° per side
- long service life 60,000 h [L80B50]
- particularly energy-efficient
- power adjustable in three steps [except DALI models]
- steel

item	colour	colour temperature	light current	dimensions L x L x H	power	control	price
707141	white	4000 K	3400 lm	600 x 60 x 54 mm	20 W		149,95 €
707142	black	4000 K	3400 lm	600 x 60 x 54 mm	20 W		149,95 €
707143	white	4000 K	8000 lm	1493 x 60 x 54 mm	50 W		184,95 €
707144	black	4000 K	8000 lm	1493 x 60 x 54 mm	50 W		184,95 €
707145	white	4000 K	8000 lm	1493 x 60 x 54 mm	50 W	DALI 2 / DT6	214,95 €
707146	black	4000 K	8000 lm	1493 x 60 x 54 mm	50 W	DALI 2 / DT6	214,95 €





with the kind support of Küchen Leicht Ettlingen



LINEAR 60 + 100

• aluminium

item	colour	colour temperature	light current	dimensions L x W x H	power	price
707147	<input type="checkbox"/> white	3000 K	2000 lm	687 x 33 x 52 mm	18 W	139,95 €
707149	<input type="checkbox"/> white	4000 K	2100 lm	687 x 33 x 52 mm	18 W	139,95 €
707148	<input checked="" type="checkbox"/> black	3000 K	2000 lm	687 x 33 x 52 mm	18 W	139,95 €
707150	<input checked="" type="checkbox"/> black	4000 K	2100 lm	687 x 33 x 52 mm	18 W	139,95 €
707151	<input type="checkbox"/> white	3000 K	3200 lm	1087 x 33 x 52 mm	28 W	179,95 €
707153	<input type="checkbox"/> white	4000 K	3300 lm	1087 x 33 x 52 mm	28 W	179,95 €
707152	<input checked="" type="checkbox"/> black	3000 K	3200 lm	1087 x 33 x 52 mm	28 W	179,95 €
707154	<input checked="" type="checkbox"/> black	4000 K	3300 lm	1087 x 33 x 52 mm	28 W	179,95 €



with the kind support of Küchen Leicht Ettingen



CAN

- aluminium diecast
- dimensions L x Ø: 134 x 60 mm

item	colour	price
707079	<input type="checkbox"/> white	49,95 €
707080	<input type="checkbox"/> silver coloured	49,95 €
707081	<input type="checkbox"/> black	49,95 €

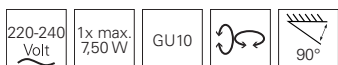

accessories

930301	reflector ring H: 28 mm white	4,95 €
930302	reflector ring H: 28 mm black	4,95 €
930303	reflector ring H: 28 mm gold optics mat	4,95 €
930366	reflector ring H: 28 mm silver coloured	4,95 €

suitable illuminants on page 800-801

HORUS

If you are looking for a slim, powerful and flexibly usable 3-phase spotlight, you will not get past the Horus. The slim housing and the matt finish of the surface, combined with the powerful chip through all wattages, makes the Horus a true all-rounder in its field.



HORUS

- plastic
- UGR <19

item	colour	colour temperature	light current	dimensions L x Ø	power	light source	EEL	price
707095	□ white	WW 3000 K	625 lm	125 x 60 mm	7 W	6 LED E		69,95 €
707097	□ white	NW 4000 K	635 lm	125 x 60 mm	7 W	6 LED E		69,95 €
707094	■ black	WW 3000 K	625 lm	125 x 60 mm	7 W	6 LED E		69,95 €
707096	■ black	NW 4000 K	635 lm	125 x 60 mm	7 W	6 LED E		69,95 €
707099	□ white	WW 3000 K	915 lm	140 x 70 mm	10 W	12 LED E		79,95 €
707101	□ white	NW 4000 K	1030 lm	140 x 70 mm	10 W	12 LED E		79,95 €
707098	■ black	WW 3000 K	915 lm	140 x 70 mm	10 W	12 LED E		79,95 €
707100	■ black	NW 4000 K	1030 lm	140 x 70 mm	10 W	12 LED E		79,95 €
707103	□ white	WW 3000 K	1705 lm	185 x 80 mm	20 W	14 LED F		89,95 €
707105	□ white	NW 4000 K	1785 lm	185 x 80 mm	20 W	14 LED F		89,95 €
707102	■ black	WW 3000 K	1705 lm	185 x 80 mm	20 W	14 LED F		89,95 €
707104	■ black	NW 4000 K	1785 lm	185 x 80 mm	20 W	14 LED F		89,95 €
707107	□ white	WW 3000 K	2525 lm	210 x 90 mm	30 W	21 LED F		109,95 €
707109	□ white	NW 4000 K	2605 lm	210 x 90 mm	30 W	21 LED F		109,95 €
707106	■ black	WW 3000 K	2525 lm	210 x 90 mm	30 W	21 LED F		109,95 €
707108	■ black	NW 4000 K	2605 lm	210 x 90 mm	30 W	21 LED F		109,95 €



AARON

Hardly any other area of application places such high demands on flexible illumination as retail. With the 3-phase spotlights of the AARON series, DEKO-LIGHT has a solution in its portfolio that is especially aimed at shops with high ceilings. With its 7400 lm and a beam angle of 40°, the 230V power rails spot perfectly sets the scene for shops, exhibitions and trade fair areas.



AARON

- aluminium
- dimensions L x W x Ø: 255 x 182 x 120 mm

item	colour	colour temperature	light current	EEL	price
707092	<input type="checkbox"/> white	<input checked="" type="checkbox"/> 3000 K	7400 lm	E	499,95 €
707093	<input type="checkbox"/> white	<input checked="" type="checkbox"/> 4000 K	7400 lm	F	499,95 €
707090	<input checked="" type="checkbox"/> black	<input checked="" type="checkbox"/> 3000 K	7400 lm	E	499,95 €
707091	<input checked="" type="checkbox"/> black	<input checked="" type="checkbox"/> 4000 K	7400 lm	F	499,95 €

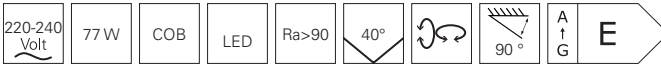



NIHAL MINI

- aluminium diecast
- dimensions L x W x H x Ø: 94 x 102 x 139 x 60 mm
- dimmable via phase control or phase cut-off

item	colour	colour temperature	light current	price
707036	white	3000 K	950 lm	169,95 €
707038	white	4000 K	1180 lm	169,95 €
707054	silver coloured	3000 K	950 lm	169,95 €
707055	silver coloured	4000 K	1180 lm	169,95 €
707037	black	3000 K	950 lm	169,95 €
707039	black	4000 K	1180 lm	169,95 €

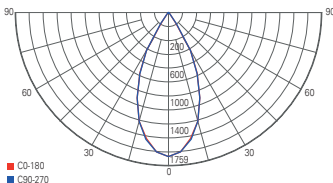

light distribution curve



accessories

930301	reflector ring white	4,95 €
930302	reflector ring black	4,95 €
930303	reflector ring gold	4,95 €
930366	reflector ring silver	4,95 €
930297	side cover white	3,95 €
930298	side cover black	3,95 €
930364	side cover silver	3,95 €
930299	side cover gold	3,95 €
930300	side cover walnut look	5,95 €
930768	side cover oak wood look natural	5,95 €
930306	reflector 48°	8,95 €
930307	honeycomb filter	8,95 €
930308	spread lens 40° clear/satined	8,95 €
930309	softening lens 47° satined	8,95 €
930310	linear spread lens 40°/80° asymmetric clear/satined	8,95 €



NIHAL

- aluminium diecast
- dimensions L x W x H x Ø: 135 x 138 x 188 x 86 mm
- dimmable via phase control or phase cut-off

item	colour	colour temperature	light current	price
707040	<input type="checkbox"/> white	<input checked="" type="checkbox"/> 3000 K	2450 lm	219,95 €
707042	<input type="checkbox"/> white	<input checked="" type="checkbox"/> 4000 K	2860 lm	219,95 €
707056	<input type="checkbox"/> silver coloured	<input checked="" type="checkbox"/> 3000 K	2470 lm	219,95 €
707057	<input type="checkbox"/> silver coloured	<input checked="" type="checkbox"/> 4000 K	2860 lm	219,95 €
707041	<input checked="" type="checkbox"/> black	<input checked="" type="checkbox"/> 3000 K	2450 lm	219,95 €
707043	<input checked="" type="checkbox"/> black	<input checked="" type="checkbox"/> 4000 K	2860 lm	219,95 €

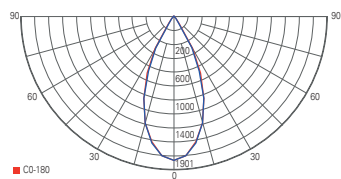

light distribution curve



accessories

930315	reflector ring white	4,95 €
930316	reflector ring black	4,95 €
930365	reflector ring silver	4,95 €
930317	reflector ring gold	4,95 €
930311	side cover white	5,95 €
930312	side cover black	5,95 €
930363	side cover silver	5,55 €
930313	side cover gold	5,95 €
930314	side cover walnut look	7,95 €
930769	side cover oak wood look natural	7,95 €
930318	reflector 15°	17,95 €
930320	reflector 48°	17,95 €
930321	honeycomb filter	10,95 €
930322	spread lens 40° clear/satined	10,95 €
930323	softening lens 47° satined	10,95 €
930324	linear spread lens 40°/80° asymmetric clear/satined	10,95 €

PLEIONE FOCUS

Power rails convince in shops, showrooms, offices and more with their unrivalled flexibility. The PLEIONE FOCUS I and II track-mounted spotlights crown this flexibility by enabling the beam angle to be continuously adjusted in the range from 25° to 60°. At the same time, the lens can be focused to highlight objects and surfaces precisely and with high colour fidelity.



PLEIONE FOCUS I

- aluminium diecast
- dimensions L x H x Ø: 181 x 180 x 68 mm
- fokussierbare lens
- light cone infinitely adjustable [25°-60°]

item	colour	colour temperature	light current	price
707069	<input type="checkbox"/> white	3000 K	1100 lm	209,95 €
707070	<input type="checkbox"/> white	4000 K	1150 lm	209,95 €

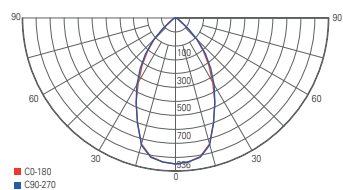

light distribution curve 707069

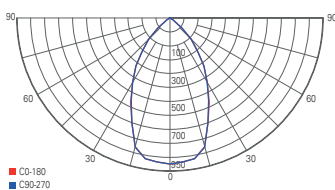

light distribution curve 707070

with the kind support of Küchen Leicht-Ettingen



PLEIONE FOCUS II

- aluminium diecast
- dimensions L x H x Ø: 195 x 160 x 90 mm
- fokussierbare lens
- light cone infinitely adjustable [25°-60°]

item	colour	colour temperature	light current	price
707067	<input type="checkbox"/> white	3000 K	3050 lm	299,95 €
707068	<input type="checkbox"/> white	4000 K	3300 lm	299,95 €

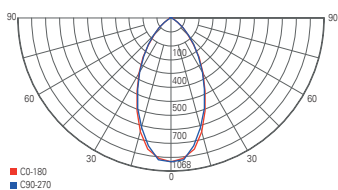
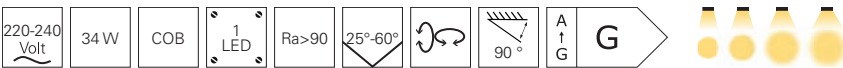

light distribution curve 707067

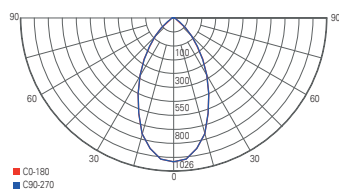

light distribution curve 707068

LUCEA

We offer spots from the LUCEA series for the 3-phase 230V track system. In the ceiling luminaire version, they are available with 10, 15, 20, 30 and 40 W and thus enable a maximum light output of up to 4,000 lumens. Optional lenses can be used to narrow or widen the beam angle of the individual models. A barn door is also available as an optional accessory for all versions, so that the luminaires can also be used flexibly in commercial and industrial environments.

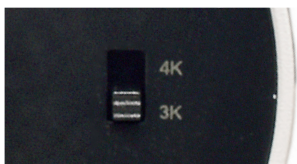

suitable
pendant lights
page 26
342177
342178



suitable
ceiling surface-
mounted lamps
from page 83
348153
348154
348161
348162

LUCEA 10

- high colour rendering
- light colour adjustable in two steps
- dimmable
- rotatable and swivellable
- aluminium diecast
- dimensions H x Ø: 249 x 65 mm
- dimmable via phase control or phase cut-off

item	colour	colour temperature	light current	price
707116	□ white	WW NW 3000 / 4000 K	930 / 1000 lm	139,95 €
707117	■ black	WW NW 3000 / 4000 K	930 / 1000 lm	139,95 €



accessories

930679	lens 24° for LUCEA 6/10	9,95 €
930752	barn door for LUCEA 6/10 white	22,95 €
930753	barn door for LUCEA 6/10 black	22,95 €
930756	reflector ring for LUCEA 6/10 white	4,95 €
930757	reflector ring for LUCEA 6/10 black	4,95 €
930758	reflector ring for LUCEA 6/10 gold	4,95 €





suitable
pendant lights
page 27
342179-342182

LUCEA 15 + 20

- high colour rendering
- light colour adjustable in two steps
- dimmable
- rotatable and swivellable
- aluminium diecast
- dimensions H x Ø: 269 x 85 mm
- dimmable via phase control or phase cut-off

item	colour	colour temperature	light current	power	price
707118	white	3000 / 4000 K	1460 / 1500 lm	15 W	159,95 €
707119	black	3000 / 4000 K	1460 / 1500 lm	15 W	159,95 €
707120	white	3000 / 4000 K	1930 / 2000 lm	20 W	179,95 €
707121	black	3000 / 4000 K	1930 / 2000 lm	20 W	179,95 €



suitable
ceiling surface-
mounted lamps
from page 84
348155-348158
348163-348166



accessories

930680	lens 24° for LUCEA 15/20	12,95 €
930681	lens 60° for LUCEA 15/20	12,95 €
930754	barn door for LUCEA 15/20 white	23,95 €
930755	barn door for LUCEA 15/20 black	23,95 €
930759	reflector ring for LUCEA 15/20 white	5,95 €
930760	reflector ring for LUCEA 15/20 black	5,95 €
930761	reflector ring for LUCEA 15/20 gold	5,95 €



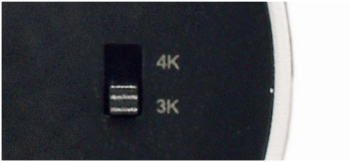

LUCEA 30

- high colour rendering
- light colour adjustable in two steps
- dimmable
- rotatable and swivellable
- aluminium diecast
- dimensions H x Ø: 302 x 100 mm
- dimmable via phase control or phase cut-off



item	colour	colour temperature	light current	price
707122	white	3000 / 4000 K	2700 / 2900 lm	199,95 €
707123	black	3000 / 4000 K	2700 / 2900 lm	199,95 €

suitable ceiling surface-mounted lamps from page 85
348159
348160
348167
348168



accessories

930682	lens 24° for LUCEA 30/40	15,95 €
930684	lens 60° for LUCEA 30/40	15,95 €
930677	barn door for LUCEA 30/40 white	24,95 €
930678	barn door for LUCEA 30/40 black	24,95 €
930762	reflector ring for LUCEA 30/40 white	6,95 €
930763	reflector ring for LUCEA 30/40 black	6,95 €
930764	reflector ring for LUCEA 30/40 gold	6,95 €





suitable
pendant lights
from page 26
342177-342182

LUCEA 40

- dimmable via phase cut-in or phase cut-out
- rotatable and swivelling
- aluminium diecast
- dimensions H x Ø: 315 x 100 mm

item	colour	colour temperature	light current	price
707183	white	4000 K	4000 lm	199,95 €
707184	black	4000 K	4000 lm	199,95 €

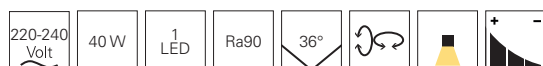

suitable
ceiling
surface-
mounted lamps
from page 83
348153-348160
348161-348168



accessories

930682	lens 24° for LUCEA 30/40	15,95 €
930684	lens 60° for LUCEA 30/40	15,95 €
930677	barn door for LUCEA 30/40 white	24,95 €
930678	barn door for LUCEA 30/40 black	24,95 €
930762	reflector ring for LUCEA 30/40 white	6,95 €
930763	reflector ring for LUCEA 30/40 black	6,95 €
930764	reflector ring for LUCEA 30/40 gold	6,95 €



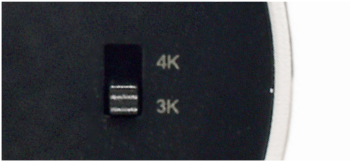

suitable
pendant lights
page 26
342177
342178

LUCEA 10

- aluminium diecast
- dimensions H x Ø: 157 x 65 mm
- max. suspension: 1800 mm
- dimmable via phase control or phase cut-off
- light color adjustable via DIP switch

item	colour	colour temperature	light current	price
707124	white	3000 / 4000 K	930 / 1000 lm	149,95 €
707125	black	3000 / 4000 K	930 / 1000 lm	149,95 €

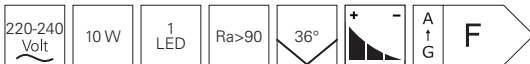

suitable
ceiling surface-
mounted lamps
from page 83
348153
348154
348161
348162



accessories

930679	lens 24° for LUCEA 6/10	9,95 €
930752	barn door for LUCEA 6/10 white	22,95 €
930753	barn door for LUCEA 6/10 black	22,95 €
930756	reflector ring for LUCEA 6/10 white	4,95 €
930757	reflector ring for LUCEA 6/10 black	4,95 €
930758	reflector ring for LUCEA 6/10 gold	4,95 €



LUCEA 15 + 20

- aluminium diecast
- dimensions H x Ø: 178 x 85 mm
- max. suspension: 1800 mm
- dimmable via phase control or phase cut-off
- light color adjustable via DIP switch

suitable
pendant lights
page 27
342179
342180
342181
342182

item	colour	colour temperature	light current	power	price
707126	<input type="checkbox"/> white	<input type="checkbox"/> WW <input type="checkbox"/> NW 3000 / 4000 K	1460 / 1500 lm	15 W	169,95 €
707127	<input checked="" type="checkbox"/> black	<input type="checkbox"/> WW <input type="checkbox"/> NW 3000 / 4000 K	1460 / 1500 lm	15 W	169,95 €
707128	<input type="checkbox"/> white	<input type="checkbox"/> WW <input type="checkbox"/> NW 3000 / 4000 K	1930 / 2000 lm	20 W	189,95 €
707129	<input checked="" type="checkbox"/> black	<input type="checkbox"/> WW <input type="checkbox"/> NW 3000 / 4000 K	1930 / 2000 lm	20 W	189,95 €



suitable
ceiling surface-
mounted lamps
from page 84
348155-348158
348163-348166



accessories

930680	lens 24° for LUCEA 15/20	12,95 €
930681	lens 60° for LUCEA 15/20	12,95 €
930754	barn door for LUCEA 15/20 white	23,95 €
930755	barn door for LUCEA 15/20 black	23,95 €
930759	reflector ring for LUCEA 15/20 white	5,95 €
930760	reflector ring for LUCEA 15/20 black	5,95 €
930761	reflector ring for LUCEA 15/20 gold	5,95 €



SLIM

For the track system, we offer matching pendant luminaires of the SLIM series. The luminaire body made of die-cast aluminium is always the same size [300 x 39mm]. The pendant luminaires for the track system allow for a maximum suspension of 180 cm. This makes the single-flame SLIM track luminaire particularly suitable for gastronomy and retail projects with changing room layout. The quality of the SLIM series is rounded off by a flexible textile cable.



SLIM

- particularly soft textile cable
- glare-free thanks to low UGR value [<19]
- slim design with a diameter of only 39 mm
- aluminium diecast
- dimensions H x \varnothing : 300 x 39 mm
- max. suspension: 1800 mm

item	colour	colour temperature	light current	control	price
707162	<input type="checkbox"/> white	2700 K	500 lm	dimmmable	89,95 € NEW
707161	<input checked="" type="checkbox"/> black	2700 K	500 lm	dimmmable	89,95 € NEW
707133	<input type="checkbox"/> white	3000 K	500 lm		84,95 €
707132	<input checked="" type="checkbox"/> black	3000 K	500 lm		84,95 €



suitable
pendant lights
from page 29
342213-342218
342237-342242

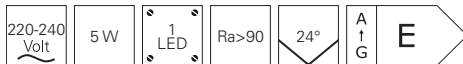

accessories

930747	lens 15°	4,95 €
930748	lens 36°	4,95 €
930749	lens 60°	4,95 €
930744	reflector ring white	4,95 €
930745	reflector ring black	4,95 €
930746	reflector ring gold	5,95 €



UNI II

- aluminium diecast
- dimensions L x Ø: 167 x 100 mm
- dimmable via phase control or phase cut-off

item	colour	colour temperature	light current	price
707044	□ white	ww 3000 K	910 lm	179,95 €
707131	■ black	ww 3000 K	910 lm	179,95 €



suitable
recessed ceiling
lights
from page 138
565343
565361



suitable
wall-mounted
luminaires
page 171
341215
341232



suitable
ceiling surface-
mounted lamps
from page 72
348124
348176
348125
348175
348107
348210



accessories

930339	reflector ring black	10,95 €
930340	reflector ring gold	10,95 €
930341	reflector ring chrom	10,95 €
930371	reflector ring II black glossy	10,95 €
930335	cover backside black	2,95 €
930337	cover heatsink black	7,95 €
930306	reflector 48°	8,95 €
930307	honeycomb filter	8,95 €
930308	spread lens 40° clear/satined	8,95 €
930309	softening lens 47° satined	8,95 €
930310	linear spread lens 40°/80° asymmetric clear/satined	8,95 €



STUDIO PAR 30

- aluminium
- dimensions L x H: 271 x 159 mm
- integrated splinter protection grid
- incl. adapter

item	colour	price
707083	□ silver coloured	69,95 €
707082	■ black	69,95 €



accessories

001623	barn door silver coloured	29,95 €
001621	barn door black	29,95 €

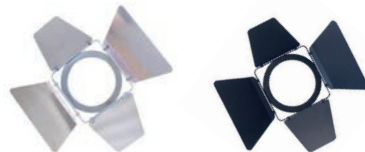

suitable illuminants on page 804



BATTERY AND SOLAR LIGHTS

356 battery lights

370 solar lights



Color swatches: white, grey, black, red, yellow, blue, green.
page 360



Color swatches: white, grey, black, red, yellow, blue, green.
page 360



Color swatches: white, grey, black, red, yellow, blue, green.
page 361



Color swatches: white, grey, black, red, yellow, blue, green.
page 361



Color swatches: white, black, grey, brown, teal, orange, blue, dark brown.
page 363



Color swatches: white, black, grey, brown, teal, orange, blue, dark brown.
page 365



Color swatches: white, black.
page 367



Color swatches: white, black.
page 367



Color swatches: dark grey.
page 368



Color swatches: dark grey.
page 371



Color swatches: dark grey, white.
page 371



Color swatches: dark grey.
page 373



Color swatches: dark grey.
page 373



battery and solar lights



MIRAM

Combine & shine – with the MIRAM series, there are no more limits to your creativity. Simply combine the luminaire head in your favourite colour with a stand, a wall bracket or a pendant fixture of your choice. In this way, you can create your very own individual luminaire in the twinkling of an eye and recombine it at any time without tools. Flexible, simple, chic - that is MIRAM combine & shine.



it's that simple:

- choose a luminaire head in your favourite colour
- select the desired fastening in your favourite colour

your advantages::

- USB-C cable included
- 147 possible combinations



346025



346033



346032



346034



346035



346036



346037



930625



930627



930626



930628



930629



930630



930631



930618



930620



930619



930621



930622



930623



930624



930611



930613



930612



930614



930615



930616



930617





HEAD MAGNETIC LIGHT MIRAM

- high battery life [>10h]
- easy charging via charging station with USB cable [incl.]
- >190lm
- infinitely dimmable via touch sensor
- can be combined with all brackets of the series thanks to magnetic attachment
- aluminium diecast
- dimensions H x Ø: 30 x 120 mm

item	colour	colour temperature	light current	price
346025	white	3000 K	196 lm	99,95 €
346033	grey	3000 K	196 lm	99,95 €
346032	black	3000 K	196 lm	99,95 €
346034	red	3000 K	196 lm	99,95 €
346035	yellow	3000 K	196 lm	99,95 €
346036	blue	3000 K	196 lm	99,95 €
346037	green	3000 K	196 lm	99,95 €

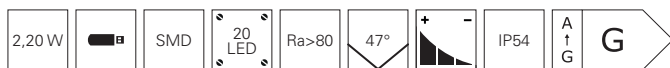

STAND FOR MAGNETIC LIGHT MIRAM

- can be combined as desired with any luminaire head from the MIRAM series
- aluminium diecast
- dimensions H x Ø: 270 x 102 mm

item	colour	price
930611	white	34,95 €
930613	grey	34,95 €
930612	black	34,95 €
930614	red	34,95 €
930615	yellow	34,95 €
930616	blue	34,95 €
930617	green	34,95 €



WALL BRACKET FOR MAGNETIC LIGHT MIRAM

- can be combined as desired with any luminaire head from the MIRAM series
- aluminium diecast
- dimensions W x H: 85 x 96 mm
- socket Ø: 60 mm

item	colour	price
930618	white	19,95 €
930620	grey	19,95 €
930619	black	19,95 €
930621	red	19,95 €
930622	yellow	19,95 €
930623	blue	19,95 €
930624	green	19,95 €



PENDANT FOR MAGNETIC LIGHT MIRAM

- can be combined as desired with any luminaire head from the MIRAM series
- mounting without drilling and screwing
- aluminium diecast
- dimensions W x H: 205 x 185 mm
- max. suspension: 2190 mm

item	colour	price
930625	white	34,95 €
930627	grey	34,95 €
930626	black	34,95 €
930628	red	34,95 €
930629	yellow	34,95 €
930630	blue	34,95 €
930631	green	34,95 €



CANIS

Discover our portable LED battery lights of the CANIS series. With 3.5 W power and 270 lm brightness, our luminaires offer a particularly wide and pleasant light distribution. Thanks to the infinitely dimming function via the practical touch sensor, you can adjust the lighting according to your preferences. Simply switch between 2 light colour levels, to create the perfect atmosphere. And the best part? One rechargeable battery lasts for more than eight hours of illumination. With the optional charging station, you can charge up to six luminaires at the same time and always have enough light sources available. Choose from eight different colours, including trendy pastel shades, to emphasise your personal style.





light colour adjustable in two steps



CANIS

• USB charging base not included [optional]

- pleasant and wide light distribution
- more than 8 h light duration after charging
- continuously dimmable via touch sensor
- light colour adjustable in two steps
- optional stackable 6-compartment charging station
- aluminium diecast
- dimensions H x Ø: 356 x 112 mm

item	colour	colour temperature	light current	price
346049	white matt	2200/3000 K	270 lm	99,95 €
346050	black matt	2200/3000 K	270 lm	99,95 €
346051	dark grey matt	2200/3000 K	270 lm	99,95 €
346022	beige matt	2200/3000 K	270 lm	99,95 €
346045	mint green matt	2200/3000 K	270 lm	99,95 €
346046	Terracotta matt	2200/3000 K	270 lm	99,95 €
346047	blue matt	2200/3000 K	270 lm	99,95 €
346048	rust-coloured matt	2200/3000 K	270 lm	99,95 €

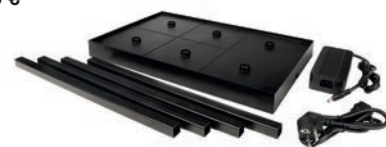

accessories

- 930714** USB charging socket with USB A without power supply
- 930716** 6-fold charging station incl. power supply

11,95 €

199,95 €



CANIS MINI

Discover our portable LED battery lights of the CANIS series. With 2.3 W power and 110 lm brightness, our luminaires offer a particularly wide and pleasant light distribution. Thanks to the infinitely dimming function via the practical touch sensor, you can adjust the lighting according to your preferences. Simply switch between 2 light colour levels, to create the perfect atmosphere. And the best part? One rechargeable battery lasts for more than eight hours of illumination. With the optional charging station, you can charge up to fifteen luminaires at the same time and always have enough light sources available. Choose from eight different colours, including trendy pastel shades, to emphasise your personal style.





CANIS MINI

- USB charging base not included [optional]
- pleasant and wide light distribution
- more than 8 h light duration after charging
- continuously dimmable via touch sensor
- light colour adjustable in two steps
- optional stackable 15-compartment charging station
- aluminium diecast
- dimensions H x Ø: 208 x 76 mm

item	colour	colour temperature	light current	price
346082	white matt	2200/3000 K	110 lm	89,95 €
346083	black matt	2200/3000 K	110 lm	89,95 €
346084	dark grey matt	2200/3000 K	110 lm	89,95 €
346077	beige matt	2200/3000 K	110 lm	89,95 €
346078	mint green matt	2200/3000 K	110 lm	89,95 €
346079	Terracotta matt	2200/3000 K	110 lm	89,95 €
346080	blue matt	2200/3000 K	110 lm	89,95 €
346081	rust-coloured matt	2200/3000 K	110 lm	89,95 €



accessories

- 930732** USB charging socket with USB A without power supply
- 930734** 15-fold charging station incl. power supply

9,95 €

299,95 €



SHERATAN

The SHERATAN is a battery-operated LED table lamp that can be charged via an integrated USB connection. This makes the SHERATAN suitable not only for use as accent light in living rooms, but also at events such as galas, corporate events and garden parties. The 38 cm high housing with wavy or smooth lampshade and stable base plate made of robust die-cast aluminium [IP54] houses a 2.2 watt LED bulb that produces a pleasant warm white light with 3000 K and can be switched on and off via a touch sensor.



SHERATAN I DIM

- high battery life [>10h]
- infinitely dimmable via touch sensor
- noble look
- IP54
- aluminium diecast
- dimensions L x W x H x Ø: 100 x 100 x 380 x 110 mm
- socket L x W x H: 100 x 100 x 11 mm
- USB-Micro charging socket
- incl. lithium battery | 2x 2200 mAh

item	colour	colour temperature	light current	price
346011	<input type="checkbox"/> white	3000 K	154 lm	129,95 €
346012	<input checked="" type="checkbox"/> black	3000 K	154 lm	129,95 €



accessories

930460 230V USB plug-in power supply incl. micro-USB connection cable **19,95 €**



SHERATAN II DIM

- high battery life [>10h]
- infinitely dimmable via touch sensor
- noble look
- IP54
- aluminium diecast
- dimensions L x W x H x Ø: 100 x 100 x 380 x 115 mm
- socket L x W x H: 100 x 100 x 11 mm
- USB-Micro charging socket
- incl. lithium battery | 2x 2200 mAh

item	colour	colour temperature	light current	price
346013	<input type="checkbox"/> white	3000 K	154 lm	129,95 €
346014	<input checked="" type="checkbox"/> black	3000 K	154 lm	129,95 €

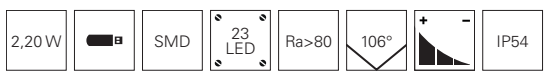

accessories

930460 230V USB plug-in power supply incl. micro-USB connection cable **19,95 €**

LACERTAE USB

Be outside, have fun and simply take the light with you. No problem with this faithful companion. Thanks to its 3-stage dimming function, the LACERTAE USB is a favourite for cosy reading by the lake or a romantic picnic in the park. With the integrated power bank, it not only supports your garden party with light, but also ensures that the music doesn't run out of steam. The LACERTAE USB – a must-have for all those who want to be free.



LACERTAE USB

- portable
- powerbank function with USB-A socket
- three-stage dimmable
- incl. 7800mAh lithium battery
- real glass panes
- aluminium diecast
- dimensions L x W x H: 180 x 180 x 267 mm
- socket L x W x H: 145 x 145 x 25 mm
- USB-Micro charging socket

item	colour	colour temperature	light current	price
346009	dark grey	3000 K	460 lm	149,95 €



accessories

930460	230V USB plug-in power supply incl. micro-USB connection cable	19,95 €
---------------	--	----------------





SAMAS SOLAR

Not everywhere you want light, there is also electricity. We have the solution. The SAMAS SOLAR series only needs one thing to shine; sunshine every now and then. Thanks to its intelligent economy mode, in which it shines with only 15% light output when not in use, it has a particularly long burning time. As soon as it detects approach via its integrated sensor, it shines with full power. It can also be deactivated via a push-button. The powerful light output combined with the latest technology for long operating times is a real problem solver for walls, tables and gardens.



SAMAS SOLAR

- aluminium diecast
- dimensions L x W x H: 154 x 140 x 290 mm
- socket L x W x H: 110 x 30 x 12 mm
- motion / twilight sensor
- highly efficient solar panel
- incl. Li-Ion battery | 3,70V | 2200 mAh

item	colour	colour temperature	light current	price
731122	■ dark grey	www 3000 K	130 lm	129,95 €

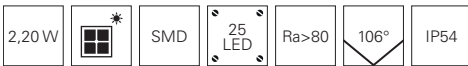

SAMAS SOLAR

- aluminium diecast
- dimensions L x W: 140 x 140 mm
- socket L x W x H: 100,50 x 100,50 x 22,00 mm
- motion / twilight sensor
- highly efficient solar panel
- incl. Li-Ion battery | 3,70V | 2200 mAh
- incl. ground spike

item	colour	colour temperature	light current	dimensions H	price
733049	■ dark grey	www 3000 K	170 lm	340 mm	129,95 €
733050	■ dark grey	www 3000 K	135 lm	500 mm	139,95 €

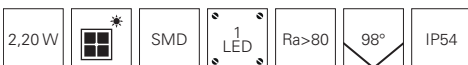



SOLAR PREMIUM

The SOLAR PREMIUM series impresses with its futuristic design and functions as an innovative and decorative outdoor luminaire in the outdoor and garden area. The power supply is provided by the integrated rechargeable battery including solar panel, so that no visually disturbing or complicated cables are necessary.



SOLAR PREMIUM I

- aluminium
- dimensions L x W x H: 160,5 x 233,2 x 152 mm
- socket L x W x H: 160,5 x 31,5 x 80,5 mm
- motion / twilight sensor
- highly efficient solar panel
- incl. Li-Ion battery | 3,70V | 2200 mA
- tiltable luminaire head



item	colour	colour temperature	light current	price
731116	■ dark grey	www 3200 K	170 lm	149,95 €

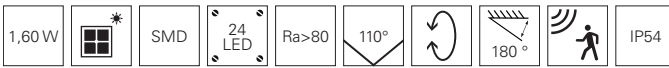

SOLAR PREMIUM I

- aluminium
- dimensions L x W x H: 200 x 151 x 1000 mm
- socket L x W x H: 80 x 151 x 4,5 mm
- motion / twilight sensor
- highly efficient solar panel
- incl. Li-Ion battery | 3,70V | 2200 mA
- tiltable luminaire head



item	colour	colour temperature	light current	price
733046	■ dark grey	www 3200 K	170 lm	219,95 €

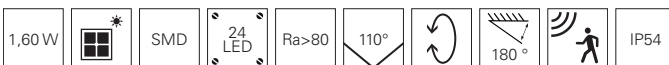



OUTDOOR LIGHTS

- 376 bollard lights
- 402 surface mounted wall lights
- 432 ceiling and wall lights
- 438 built in wall lights
- 446 spherical lamps
- 450 energy distributor
- 460 surface mounted and ground spike lights
- 472 wall washer
- 476 ground recessed lights
- 502 floodlight
- 512 display lights



□
page 378



□ □
page 378



□
page 379



□
page 379



□
page 380



□
page 380



■
page 381



■ ■ □
page 383



■ □
page 385



■ □
page 386



■ □
page 388



■ □
page 389



■ □
page 390



■
page 391



■ □
page 391



■ □
page 393



■ □
page 394



■ □
page 397



■ □
page 398



■ □
page 401



bollard lights



IP



ESTADA

- stainless steel
- dimensions H x Ø: 1000 x 100 mm
- socket Ø: 170 mm
- dimmable via optional illuminants

item	colour	price
730009	 silver coloured	119,95 €





suitable illuminants on page 803
 suitable mounting accessories for outdoor use from page 827

IP



PORRIMA

- stainless steel
- socket H x Ø: 8 x 118 mm
- dimmable via optional illuminants

item	colour	dimensions H x Ø	price
733012	 silver coloured brushed	500 x 76 mm	64,95 €
733028	 silver coloured brushed	1000 x 76 mm	74,95 €



suitable illuminants on page 800-801
 suitable mounting accessories for outdoor use from page 827



suitable wall light
page 406
730034

NOVA

- stainless steel
- dimensions H x Ø: 1100 x 75 mm
- socket Ø: 110 mm
- dimmable via optional illuminants
- E27 socket suitable for A19 LED bulb

item	colour	price
730007	 silver coloured brushed	79,95 €

				
---	---	---	---	---

suitable mounting accessories for outdoor use from page 827









suitable wall lights
page 406
730034

NOVA MOTION

- stainless steel
- dimensions H x Ø: 1100 x 75 mm
- socket Ø: 110 mm
- motion / twilight sensor
- E27 socket suitable for A19 LED bulb

item	colour	price
730032	 silver coloured brushed	99,95 €

					
---	---	---	---	---	---

suitable mounting accessories for outdoor use from page 827



suitable
wall lights
page 405
731008
731009

ZILLY II

- stainless steel
- dimensions L x W: 500 x 140 mm
- socket H x Ø: 7 x 100 mm
- swivelling luminaire head
- dimmable via optional illuminants

item	colour	price
733062	 silver coloured	89,95 €



suitable illuminants on page 800-801
suitable mounting accessories for outdoor use from page 827



suitable
wall lights
page 405
731010
731011

ZILLY II

- stainless steel
- dimensions L x W: 1000 x 232 mm
- socket H x Ø: 7 x 100 mm
- swivelling luminaire head
- dimmable via optional illuminants

item	colour	price
733063	 silver coloured	129,95 €



suitable illuminants on page 800-801
suitable mounting accessories for outdoor use from page 827



ARBINTO

The ARBINTO with its high standing base and the light emission with E27 bulb as well as real glass frame reminds of a torch and creates an immediate feeling of warmth and security.



ARBINTO

- aluminium diecast
- dimensions L x W: 800 x 120 mm
- socket Ø: 140 mm
- dimmable via optional illuminants

item	colour	price
733061	 anthracite	119,95 €



suitable illuminants on page 803-805
 suitable mounting accessories for outdoor use from page 827





FACADO

The floor lamps of the FACADO series have already been used for some time on paved walkways in the garden area. With FACADO, the classically elegant outdoor lights [IP44] become even more versatile. Thanks to the E27 socket, the light source can be changed as needed and adapted to the desired lighting mood. FACADO is available in two heights [65 and 100 cm]. This series is rounded off with the new energy distributor on page 457.



suitable
wall light
page 406
731059

FACADO A + B

- aluminium diecast
- socket L x W: 110 x 110 mm
- dimmable via optional illuminants

item	colour	dimensions L x W x H	price
730332	anthracite	110 x 110 x 650 mm	129,95 €
730333	brown	110 x 110 x 650 mm	129,95 €
733018	anthracite	110 x 110 x 1000 mm	174,95 €



suitable illuminants on page 803-805
suitable mounting accessories for outdoor use from page 827



suitable energy
distributor
page 457
733064
733065



CATA IV

The CATA IV series is not only convincing as a modern path luminaire, but also as an independent light and design object in the design of outdoor areas. The LEDs not only provide wide-area illumination of walkways and entrance areas, but also inevitably draw the eye to the striking frame construction. Available in three sizes, the CATA IV models can also be combined very well.



CATA IV

- aluminium diecast
- socket L x W x H: 145 x 55 x 20 mm

item	colour	colour temperature	light current	dimensions L x W x H	price
733040	■ anthracite	3000 K	170 lm	151 x 61 x 500 mm	189,95 €
733041	■ anthracite	3000 K	170 lm	151 x 61 x 700 mm	209,95 €
733042	■ anthracite	3000 K	170 lm	151 x 61 x 1000 mm	235,95 €

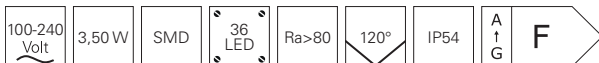

suitable mounting accessories for outdoor use from page 827

CHERTAN

With its unusual material mix of die-cast aluminium housing and a concrete base, the CHERTAN outdoor floor lamp stands out visually from other models. With its pleasant warm white light and a beam angle of 120°, the outdoor luminaire is perfect for decorative use in entrance areas, on walkways or in the garden.



CHERTAN

- aluminium diecast | glass fibre reinforced concrete
- socket L x W x H: 160 x 30 x 40 mm

item	colour	colour temperature	light current	dimensions L x W x H	price
733043	■ grey	ww 3000 K	480 lm	170 x 72 x 450 mm	199,95 €
733044	■ grey	ww 3000 K	530 lm	170 x 72 x 600 mm	219,95 €
733045	■ grey	ww 3000 K	640 lm	170 x 72 x 1000 mm	239,95 €

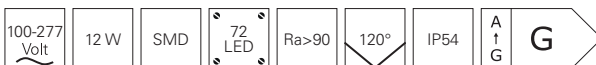

suitable mounting accessories for outdoor use from page 827

suitable wall light
page 408
731113





RUKBAT

- aluminium diecast
- socket L x W x H: 145 x 145 x 20 mm

item	colour	colour temperature	light current	dimensions L x W x H	price
733047	■ anthracite	www 3000 K	670 lm	85 x 85 x 500 mm	159,95 €
733048	■ anthracite	www 3000 K	670 lm	85 x 85 x 800 mm	219,95 €



suitable mounting accessories for outdoor use from page 827



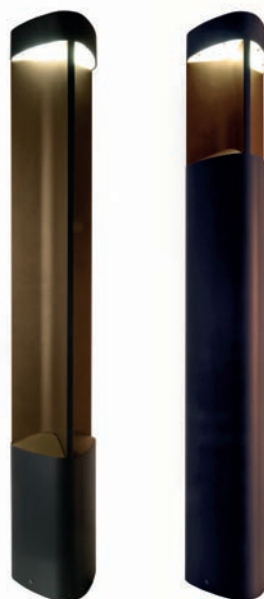

TRILA + TRILA II

- aluminium diecast
- dimensions L x W x H: 128,5 x 123 x 800 mm
- socket Ø: 120 mm

item	colour	colour temperature	light current	price
730364	anthracite	3000 K	361 lm	159,95 €
730365	anthracite	3000 K	361 lm	159,95 €

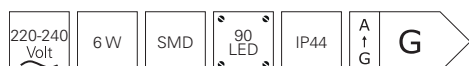

suitable mounting accessories for outdoor use from page 827





ORTIS

- aluminium diecast
- dimensions L x Ø: 1000 x 120 mm
- light dimmed by the louvre insert, light directed downwards

item	colour	colour temperature	light current	price
733004	■ dark grey	ww 3000 K	510 lm	219,95 €

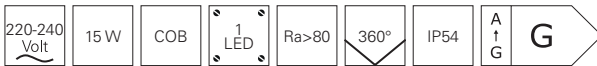

suitable mounting accessories for outdoor use from page 827

suitable wall light
page 407
731031





IRETTA

- aluminium diecast
- dimensions L x W x H: 165 x 192 x 700 mm
- socket L x W: 165 x 85 mm

item	colour	colour temperature	light current	price
730354	■ anthracite	ww 3000 K	240 lm	169,95 €

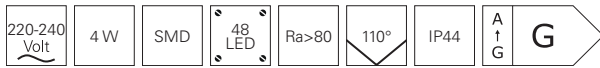

suitable mounting accessories for outdoor use from page 827

suitable wall light
page 417
730395



BEACON II MOTION

- aluminium diecast
- socket L x W x H: 102 x 102 x 7 mm
- motion / twilight sensor

item	colour	colour temperature	light current	dimensions L x W x H	price
733006	■ anthracite	ww 3000 K	290 lm	70 x 70 x 500 mm	139,95 €
733008	■ anthracite	ww 3000 K	290 lm	70 x 70 x 800 mm	159,95 €

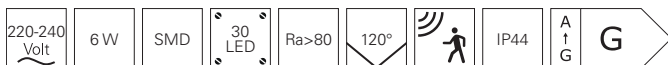

suitable mounting accessories for outdoor use from page 827

suitable wall light
page 417
731016



TAYGETA

The outdoor lights of the TAYGETA series are eye-catchers – and use their bent housing shape sensibly for illumination of walkways on both sides, walls and objects from different angles on both sides. Available in two sizes [60 cm and 100 cm], the TAYGETA 1000 is also optionally available with integrated, energy-saving motion and twilight sensor.



TAYGETA 600 + 1000 + 1000 MOTION

- aluminium diecast
- dimensions L x W: 220 x 148 mm
- socket L x W x H: 220 x 90 x 10 mm
- two separate light sources for forward and backward light
- brightness threshold and running time adjustable [733039]

item	colour	colour temperature	light current	dimensions H	price
733037	■ dark grey	■ 3000 K	1500 lm	600 mm	239,95 €
733038	■ dark grey	■ 3000 K	1500 lm	1000 mm	269,95 €
733039	■ dark grey	■ 3000 K	1500 lm	1000 mm motion / twilight sensor	298,95 €

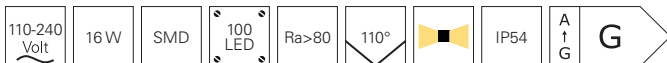

suitable mounting accessories for outdoor use from page 827

TUCANAE

With its slim, unadorned housing design, TUCANAE is a modern outdoor luminaire that can be integrated almost anywhere. The 100 cm high bollard luminaire radiates its warm white light downwards at an angle onto walkways and other surfaces and, in the MOTION version, has an integrated twilight switch with adjustable brightness threshold and runtime.



TUCANAE + TUCANAE MOTION

- modern, minimalist design
- brightness threshold and running time adjustable [733068]
- aluminium diecast
- dimensions W x H: 206 x 1000 mm
- socket L x W x H: 120 x 180 x 10 mm

suitable
wall lights
page 416
731133
731144

item	colour	colour temperature	light current	price
733069	■ dark grey	☀ 3000 K	1650 lm	239,95 €
733068	■ dark grey	☀ 3000 K	1650 lm motion / twilight sensor	259,95 €

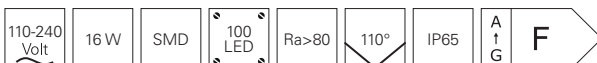

suitable mounting accessories for outdoor use from page 827





LERNA

The bollard luminaires of the LERNA series offer a variety of advantages. The fully downward directed light ensures efficient lighting without light pollution. The LERNA series is available in two different heights [600 mm and 1000 mm] to meet your individual requirements. With an output of 6 W and 516 lm, the luminaire itself offers excellent brightness.

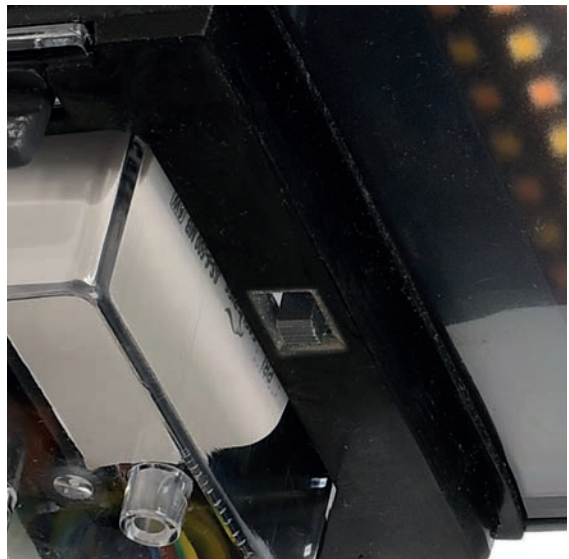



LERNA

- light colour adjustable in two levels
- 100% downward directed light, therefore no light pollution
- aluminium diecast

suitable energy distributor
page 459
733071
733070

item	colour	colour temperature	light current	dimensions L x W x H	price
733073	■ dark grey	☀️ NW 3000/4000 K	516 lm	120 x 100 x 600 mm	199,95 €
733072	■ dark grey	☀️ NW 3000/4000 K	516 lm	120 x 100 x 1000 mm	249,95 €



suitable mounting accessories for outdoor use from page 827



FARO

- glare-free, downward directed light [>97%]
- lens optics for particularly wide homogeneous illumination with up to 10 / 7 / 4 m diameter
- optional shielding screen for half-sided darkening
- aluminium diecast
- DALI 2 dimmable
- IP68 connection box with through-wiring
- particularly high-quality surface and solid construction
- dirt-repellent powder coating in DB703

item	colour	colour temperature	light current control	dimensions H x Ø	price
730492	■ dark grey	ww 3000 K	1124 lm DALI 2 / DT6	250 x 180 mm	429,95 €
730493	■ dark grey	ww 3000 K	1124 lm DALI 2 / DT6	600 x 180 mm	499,95 €
730494	■ dark grey	ww 3000 K	1124 lm DALI 2 / DT6	1000 x 180 mm	579,95 €

220-240 Volt	24W	Ra80	180/360°			IP65	IK08
--------------	-----	------	----------	--	--	------	------

accessories

930731	concrete anchor	24,95 €
930776	shielding aperture 180°	9,95 €



suitable mounting accessories for outdoor use from page 827





ALHENA

Thanks to its SMD construction, the modern, towering ALHENA luminaire with 360° light distribution not only illuminates driveways, car parks, gardens or terraces, but also appears as a design element itself.



ALHENA

- timeless design
- high luminous intensity
- homogeneous light distribution in all directions
- aluminium diecast
- socket Ø: 130 mm

item	colour	colour temperature	light current	dimensions H x Ø	power	price
733057	■ anthracite	☀ 3000 K	2965 lm	900 x 110 mm	29 W	219,95 €
733058	■ anthracite	☀ 3000 K	3900 lm	1500 x 110 mm	37 W	299,95 €

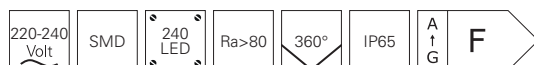

suitable mounting accessories for outdoor use from page 827



□
page 404



□ □
page 404



□ □
page 405



□ □
page 405



□
page 406



■
page 406



■
page 407



■
page 408



■
page 409



■
page 410



■
page 410



■ □
page 413



■ □
page 413



■ □
page 415



■ □
page 415



■ □
page 416



■
page 417



■
page 417



■ □
page 418



■
page 419



■ □
page 419



■ □
page 420



□ ■ ■
page 420



□ □ ■
page 421



■ □
page 421



■
page 423



■
page 423



■
page 424



■ □
page 424



■ □
page 426



■ ■
page 427



■
page 427



■ □
page 428



■
page 429



■
page 431

surface mounted wall lights



ZILLY DOWN

- stainless steel
- dimensions L x W x H x Ø: 115 x 115 x 107 x 60 mm
- socket L x W x H: 80 x 50 x 25 mm
- dimmable via optional illuminants

item	colour	price
731005	 silver coloured	44,95 €





suitable illuminants on page 800-801



ZILLY UP AND DOWN + ZILLY UP AND DOWN MOTION

- stainless steel
- dimmable via optional illuminants [only 731006]

item	colour	dimensions L x W x H x Ø	socket L x W x H x Ø	price
731006	 silver coloured	163 x 107 x 60 x 60 mm	80 x 50 x 27 mm	59,95 €
731007	 silver coloured	215 x 110 x 70 x 60 mm	150 x 68 x 27 mm motion / twilight sensor	94,95 €



suitable illuminants on page 800-801



ZILLY II DOWN + ZILLY II DOWN MOTION

- stainless steel
- dimmable via optional illuminants [only 731008]

suitable
bollard light
page 380
733062

item	colour	dimensions L x W x H x Ø	socket L x W x H x Ø	price
731008	silver coloured	125 x 60 x 105 x 60 mm	100 x 43 x 22 mm	54,95 €
731009	silver coloured	150 x 68 x 106 x 60 mm	150 x 68 x 27 mm motion / twilight sensor	84,95 €



suitable illuminants on page 800-801



ZILLY II UP AND DOWN + ZILLY II UP AND DOWN MOTION

- stainless steel
- dimmable via optional illuminants [only 731010]

suitable
bollard light
page 380
733063

item	colour	dimensions L x W x H x Ø	socket L x W x H x Ø	price
731010	silver coloured	178 x 60 x 105 x 60 mm	102 x 42 x 22 mm	89,95 €
731011	silver coloured	220 x 70 x 108 x 60 mm	148 x 67 x 25 mm motion / twilight sensor	104,95 €



suitable illuminants on page 800-801



NOVA II MOTION

- stainless steel
- dimensions L x W x H x Ø: 388 x 145 x 110 x 75 mm
- socket H x Ø: 25 x 110 mm
- motion / twilight sensor
- E27 socket suitable for A19 LED bulb

item	colour	price
730034	 silver coloured	79,95 €



suitable
bollard light
page 379
730032



FACADO A

- aluminium diecast
- dimensions L x W x H: 243 x 110 x 150 mm
- socket L x W x H: 120 x 90 x 35 mm
- dimmable via optional illuminants

item	colour	price
731059	 anthracite	104,95 €



suitable
bollard lights
page 383
730332
733018



suitable energy
distributor
page 457
733064
733065

suitable illuminants on page 803



ORTIS

- aluminium diecast
- dimensions L x W x H x Ø: 260 x 120 x 181 x 120 mm
- socket L x W x H: 100 x 77 x 67 mm
- light directed downwards and dimmed by the louvre insert

item	colour	colour temperature	light current	price
731031	■ dark grey	ww 3000 K	510 lm	189,95 €

220-240 Volt	15 W	COB	1 LED	Ra>80	360°	IP54
--------------	------	-----	-------	-------	------	------

suitable
bollard light
page 390
733004



CHERTAN

With its unusual material mix of die-cast aluminium housing and a concrete base, the CHERTAN outdoor wall luminaire stands out visually from other models. With its pleasant warm white light and a beam angle of 120° including motion and twilight switch, the outdoor luminaire is perfect for decorative use in entrance areas.



CHERTAN MOTION

- aluminium diecast | concrete
- dimensions L x W x H: 170 x 90 x 302 mm
- socket L x W x H: 110 x 22 x 800 mm
- motion / twilight sensor

item	colour	colour temperature	light current	price
731113	■ anthracite, concrete	ww 3000 K	570 lm	184,95 €

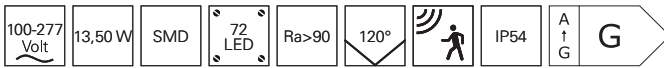

suitable
bollard lights
page 386
733043
733044
733045





ADEBAR MOTION

- timeless design
- aluminium diecast
- dimensions L x Ø: 218 x 160 mm
- motion sensor

item	colour	price
731137	 grey	99,95 €



suitable illuminants on page 803



SAIPH & SARGAS

The classic outdoor luminaires combine proven luminaire design from over 100 years with modern conveniences. The timeless wall-mounted luminaires of the new SAIPH and SARGAS series evoke reminiscences of iconic designs from various decades and impress with high-quality real glass that is not only resistant to scratches but also weather and UV-resistant.



SAIPH

- rustic design
- aluminium
- dimensions L x W x H: 170 x 149 x 280 mm
- dimmable via optional illuminants

item	colour	price
341244	■ black	54,95 €



suitable illuminants on page 800

SARGAS

- rustic design
- aluminium
- dimensions L x W x H: 178 x 151 x 318 mm
- dimmable via optional illuminants

item	colour	price
341245	■ black	54,95 €



suitable illuminants on page 800







GRUMIUM

Modular, compact, with great effect – GRUMIUM wall-mounted luminaire can be installed on terraces, house walls or in the entrance area of residential environments and, thanks to its optional covers with different designs, is a flexible universal solution for many applications. The permanently installed and energy-saving LEDs with a maximum of 10 watts are surrounded by a diffuser made of milky plastic and produce a pleasant warm white light with a luminous flux of 450 lm. With the GRUMIUM ANGULAR CCT I, even the color temperature can be adjusted between warm white and neutral white via dip switch. The GRUMIUM outdoor luminaire with its die-cast aluminum housing is available in square and rounded versions and has IP54 protection.



GRUMIUM ANGULAR CCT I

- aluminium diecast
- dimensions L x W x H: 100 x 70 x 200 mm
- socket W x H x Ø: 95 x 15 x 195 mm
- light color adjustable via DIP switch

item	colour	colour temperature	light current	price
620123	■ dark grey borders	www nw 3000/4000 K	450 lm	109,95 €
620124	■ dark grey lines diagonal	www nw 3000/4000 K	205 lm	109,95 €
620125	■ dark grey lines horizontally	www nw 3000/4000 K	280 lm	109,95 €
620126	■ dark grey lines vertical	www nw 3000/4000 K	300 lm	109,95 €
620127	■ dark grey upside/below	www nw 3000/4000 K	440 lm	109,95 €

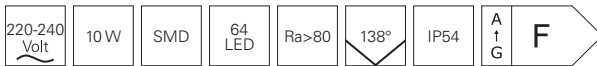

GRUMIUM ROUND I

- aluminium diecast
- dimensions L x W x H: 100 x 70 x 200 mm
- socket W x H x Ø: 95 x 15 x 195 mm

item	colour	colour temperature	light current	price
620128	■ dark grey upside/below	ww 3000 K	325 lm	109,95 €
620129	■ dark grey Taille	ww 3000 K	210 lm	109,95 €
620130	■ dark grey lines horizontally	ww 3000 K	250 lm	109,95 €





ALKES

The ALKES series is not a classic wall-mounted luminaire, but with its SMD LED panel is reminiscent of a floodlight. The highlight: the upper part of the housing is tilted forward by 45° from the façade to direct the warm white light specifically onto the surface to be illuminated. In addition, the ALKES with its modern design and rounded edges cuts a great figure even when switched off.



ALKES

- modern design
- high light output
- homogeneous light distribution
- aluminium diecast

item	colour	colour temperature	light current	power	dimensions L x W x H	price
731138	■ dark grey	www 3000 K	920 lm	21 W	200 x 126 x 184 mm	99,95 €
731140	■ dark grey	www 3000 K	1720 lm	36 W	297 x 165 x 240 mm	169,95 €

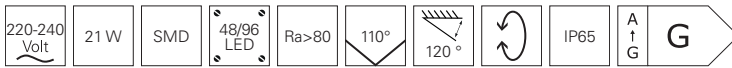

ALKES MOTION

- modern design
- high light output
- homogeneous light distribution
- aluminium diecast
- motion sensor

item	colour	colour temperature	light current	power	dimensions L x W x H	price
731139	■ dark grey	www 3000 K	735 lm	21 W	200 x 126 x 184 mm	119,95 €
731141	■ dark grey	www 3000 K	1720 lm	36 W	297 x 165 x 240 mm	189,95 €

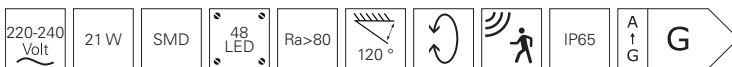



TUCANAE + TUCANAE MOTION

- modern, minimalist design
- brightness threshold and running time adjustable
- aluminium diecast
- dimensions L x W x H: 140 x 172 x 219 mm
- socket L x W x H: 125 x 135 x 15 mm



item	colour	colour temperature	light current	price
731144	■ dark grey	☀ 3000 K	1650 lm	179,95 €
731133	■ dark grey	☀ 3000 K	1650 lm motion / twilight sensor	189,95 €

suitable
bollard lights
page 394
733068
733069

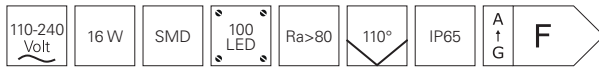



BEACON MOTION

- aluminium diecast
- dimensions L x W x H: 250 x 68 x 106 mm
- socket L x W x H: 68 x 68 x 5 mm
- motion / twilight sensor

item	colour	colour temperature	light current	price
731016	■ anthracite	ww 3000 K	290 lm	109,95 €

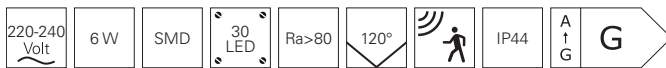

suitable
bollard lights
page 391
733006
733008



IRETTA

- aluminium diecast
- dimensions L x W x H: 150 x 125 x 97,5 mm
- socket L x W: 121 x 93 mm
- motion / twilight sensor

item	colour	colour temperature	light current	price
730395	■ anthracite	ww 3000 K	370 lm	179,95 €

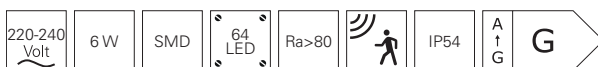

suitable
bollard light
page 391
730354

ACHERNAR

ACHERNAR with a lot of flexibility: the GU10 base in the simple aluminum die-cast housing allows free choice of illuminant for any application.



ACHERNAR DOWN + UP AND DOWN

- timeless design
- aluminium diecast
- dimmable via optional illuminants

item	colour	power	radiation characteristics	dimensions W x H x Ø	price
731130	■ anthracite	1x max. 50 W	downwards	95 x 108 x 63 mm	44,95 €
731131	■ anthracite	2x max. 35 W	up- / downwards	95 x 158 x 63 mm	54,95 €



suitable illuminants on page 800-801



MOBBY II

The conversion artist – the cable outlet is not exactly where the light is needed? No problem for the MOBBY II. Thanks to its swiveling head, areas can be illuminated that would otherwise be inaccessible. The MOBBY II is equipped with the powerful and cost-efficient 9 Watt LED module.



MOBBY II

- aluminium diecast
- dimensions H x Ø: 100 x 84 mm
- socket H x Ø: 34 x 95 mm
- dimmable via phase control or phase cut-off

item	colour	colour temperature	light current	price
731021	■ anthracite	ww 3000 K	810 lm	199,95 €



MOBBY II SINGLE + DOUBLE

- aluminium diecast
- socket L x W x H: 120 x 80 x 34 mm

item	colour	colour temperature	light current	power	radiation characteristics	dimensions L x W x H x Ø	price
731072	■ anthracite	ww 3000 K	810 lm	9 W	downwards	84 x 124 x 120 x 84 mm	199,95 €
731071	■ anthracite	ww 3000 K	1620 lm	19 W	up- / downwards	84 x 124 x 220 x 84 mm	299,95 €

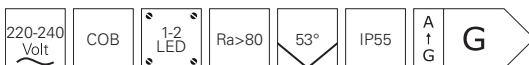

JABBAH

The square JABBAH uses integrated COB LEDs in warm white and emits its light asymmetrically at 75° in a cone shape onto walls - in the simple version with 915 lumens, as UP AND DOWN version with a total of 1850 lumens. In addition, the double-sided JABBAH can be dimmed to 60% light output via a dip switch if a more discreet light output is desired.



JABBAH + UP AND DOWN

- modern design
- dimmable to 60% via dip switch
- high luminous intensity
- aluminium diecast
- dimensions L x W x H: 150 x 150 x 150 mm

item	colour	colour temperature	light current	power	radiation characteristics	price
731128	■ dark grey	ww 3000 K	915 lm	13 W	downwards	249,95 €
731127	■ dark grey	ww 3000 K	1850 lm	25 W	up- / downwards	329,95 €



CUBODO

- aluminium diecast
- dimensions L x W x H: 90 x 110 x 90 mm
- socket L x W x H: 59 x 59 x 20 mm

item	colour	colour temperature	light current	price
730380	□ white	ww 3000 K	270 lm	124,95 €
730329	■ brown	ww 3000 K	270 lm	124,95 €
730328	■ anthracite	ww 3000 K	270 lm	124,95 €





CUBODO II SINGLE + DOUBLE

- aluminium diecast
- dimensions L x W x H: 108 x 108 x 115 mm
- socket L x W: 108 x 108 mm

item	colour	colour temperature	light current	power	radiation characteristics	price
731026	white	3000 K	600 lm	7 W	downwards	154,95 €
731025	silver coloured	3000 K	600 lm	7 W	downwards	154,95 €
731024	dark grey	3000 K	600 lm	7 W	downwards	154,95 €
731020	white	3000 K	1260 lm	14 W	up- / downwards	174,95 €
731019	silver coloured	3000 K	1260 lm	14 W	up- / downwards	174,95 €
731015	dark grey	3000 K	1260 lm	14 W	up- / downwards	174,95 €

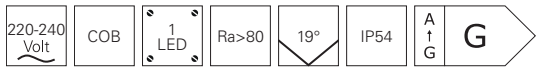

CUBODO II SINGLE DG MINI + DOUBLE DG MINI

- aluminium diecast
- socket L x W x H: 65 x 65 x 20 mm

item	colour	colour temperature	light current	power	radiation characteristics	dimensions L x W x H	price
731029	dark grey	3000 K	220 lm	4,50 W	downwards	90 x 68 x 70 mm	114,95 €
731030	dark grey	3000 K	440 lm	9,00 W	up- / downwards	90 x 68 x 108 mm	144,95 €

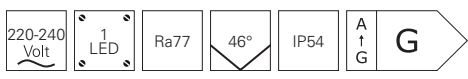



ARCTURUS

The ARCTURUS LED wall-mounted luminaire presents itself in a modern cube design [also available in an elongated form] and is suitable for flexible lighting in outdoor areas. The beam angle of the IP54 luminaire can be adjusted between 0° and 90° via an integrated shutter to generate a different light pattern depending on the application requirements. Protected in the dark grey die-cast aluminium housing are the two high-power LEDs that produce a warm white, 5.5 W light.



ARCTURUS I

- aluminium diecast
- dimensions L x W x H: 79 x 110 x 172 mm
- socket L x W x H: 68 x 110 x 110 mm
- adjustable beam angle

item	colour	colour temperature	light current	price
731099	■ dark grey	ww 3000 K	200 lm	109,95 €



ARCTURUS II

- aluminium diecast
- dimensions L x W x H: 140 x 105 x 145 mm
- socket L x W x H: 75 x 100 x 120 mm
- adjustable beam angle

item	colour	colour temperature	light current	price
731100	■ dark grey	ww 3000 K	200 lm	109,95 €

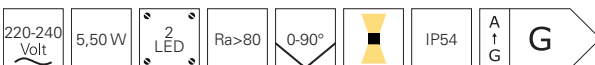



KIMBALI ANGULAR

- aluminium
- dimensions L x W x H: 160 x 90 x 50 mm
- socket L x W: 148 x 85 mm

item	colour	colour temperature	light current	price
731014	■ anthracite	www 3000 K	370 lm	114,95 €



AGUDO II SINGLE + DOUBLE

- aluminium diecast
- socket L x W: 75 x 75 mm

item	colour	colour temperature	light current	power	radiation characteristics	dimensions L x W x H	price
730381	■ anthracite	www 3000 K	70 lm	2 W	downwards	63 x 80 x 75 mm	69,95 €
730382	■ anthracite	www 3000 K	140 lm	3 W	up- / downwards	140 x 80 x 65 mm	94,95 €







ANCHA I + II

- aluminium diecast
- socket L x W x H: 74 x 12 x 83 mm

item	colour	colour temperature	light current	power	radiation characteristics	dimensions L x W x H	price
731087	■ dark grey	www 3000 K	260 lm	5,50 W	downwards	80 x 92 x 97 mm	94,95 €
731088	■ dark grey	www 3000 K	530 lm	10,00 W	up- / downwards	80 x 92 x 105 mm	124,95 €





RILONGO

- aluminium diecast
- dimensions L x W x H: 250 x 110 x 103 mm
- socket L x W: 250 x 110 mm
- dimmable via optional illuminants

item	colour	price
730330	anthracite	79,95 €
730331	brown	79,95 €



suitable illuminants on page 803



WALL LINE III

- aluminium diecast
- dimensions L x W x H: 250 x 110 x 110 mm
- socket L x W: 250 x 103 mm
- dimmable via optional illuminants

item	colour	price
731060	anthracite	79,95 €



suitable illuminants on page 803





LINEAR I SINGLE

- aluminium diecast
- socket L x W x H: 493 x 53 x 15 mm

item	colour	colour temperature	light current	power	dimensions H x T x B	EEL	price
731135	■ dark grey	ww 3000 K	600 lm	8,5 W	60 x 60 x 250 mm	G	129,95 €
731134	■ dark grey	ww 3000 K	1230 lm	14,0 W	60 x 60 x 500 mm	F	169,95 €



LINEAR II DOUBLE

- aluminium diecast
- socket L x W x H: 242 x 53 x 15 mm

item	colour	colour temperature	light current	power	dimensions H x T x B	price
731136	■ dark grey	ww 3000 K	1155 lm	14,0 W	60 x 60 x 250 mm	159,95 €
731129	■ dark grey	ww 3000 K	1760 lm	20,0 W	60 x 60 x 500 mm	189,95 €





UR1A 10

- aluminium diecast
- dimensions L x W x H: 300 x 97 x 120 mm
- socket L x W x H: 270 x 20 x 85 mm

item	colour	colour temperature	light current	price
731033	■ anthracite	ww 3000 K	408 lm	114,95 €





GIANFAR

The elegant GIANFAR outdoor wall light convinces with a classic and expressive design. Practical: The sticker set included in the scope of delivery allows you to quickly and easily transform the GIANFAR into a house number light if required.



GIANFAR

- aluminium diecast
- dimensions L x W x H: 161 x 59 x 211 mm
- socket L x W x H: 145 x 17 x 73 mm
- suitable as house number light

item	colour	colour temperature	light current	price
731119	■ dark grey	■ 3000 K	930 lm	69,95 €

100-240 Volt	12 W	SMD	60 LED	Ra>80	120°	IP54	A ↑ G	G
--------------	------	-----	--------	-------	------	------	-------------	---



accessories

948139	numbers set numbers each 3x [0 to 9] and letters each 1x [A to J]	6,95 €
---------------	---	---------------



□ ■ □
page 434



□ □
page 434



□ ■
page 435



■ □
page 436



■ □
page 436



■ □
page 437



ceiling and wall lights





MOB ROUND I + SQUARE II

- aluminium diecast
- dimmable via optional illuminants

item	colour	dimensions H x Ø / L x W x H	price
730407	<input type="checkbox"/> white	92 x 108 mm	69,95 €
730408	<input checked="" type="checkbox"/> anthracite	92 x 108 mm	69,95 €
730409	<input type="checkbox"/> white	108 x 108 x 100 mm	81,95 €
730410	<input checked="" type="checkbox"/> anthracite	108 x 108 x 100 mm	81,95 €



suitable illuminants on page 807



SCUTI

- stainless steel
- dimmable via optional illuminants

item	colour	dimensions H x Ø / L x W x H	price
731053	<input type="checkbox"/> silver coloured brushed	85 x 285 mm	89,95 €
731052	<input checked="" type="checkbox"/> silver coloured brushed	285 x 285 x 85 mm	89,95 €



suitable illuminants on page 803



AURIGAE

- aluminium diecast
- dimensions L x W x H: 250 x 250 x 60 mm
- socket L x W x H: 190 x 190 x 20 mm

item	colour	colour temperature	light current	price
348121	<input type="checkbox"/> white	3000 K	1550 lm	119,95 €
348120	<input checked="" type="checkbox"/> anthracite	3000 K	1550 lm	119,95 €

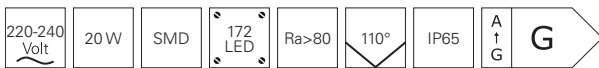



ASCELLA

- aluminium diecast
- socket H x Ø: 12 x 270 mm

item	colour	colour temperature	light current	dimensions H x Ø / L x W x H	price
348069	■ dark grey	ww 3000 K	2300 lm	50 x 340 mm	239,95 €
348070	■ dark grey	ww 3000 K	2300 lm	340 x 340 x 50 mm	239,95 €

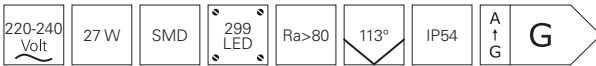

QUADRATA

- plastic

item	colour	colour temperature	light current	power	dimensions L x W x H	socket L x W x H	price
348011	■ grey	ww 3000 K	680 lm	10 W	220 x 220 x 56 mm	190 x 190 x 10 mm	109,95 €
348009	■ grey	ww 3000 K	1110 lm	16 W	296 x 296 x 78 mm	230 x 230 x 10 mm	119,95 €
348007	■ grey	ww 3000 K	1280 lm	20 W	400 x 400 x 93 mm	312 x 312 x 10 mm	169,95 €

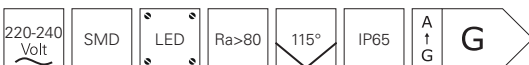



MENSÆ MOTION

- aluminium diecast
- motion detector with adjustable sensitivity, follow-up time and brightness threshold
- corridor function [can be deactivated]

item	colour	colour temperature	light current	dimensions H x Ø / L x W x H	price
348072	■ dark grey	■ 3000 K	1340 lm	48 x 300 mm	239,95 €
348071	■ dark grey	■ 3000 K	1240 lm	300 x 300 x 48 mm	239,95 €





□ ■
page 440



□ ■
page 440



□ ■
page 440



□ □ ■
page 443



□ □ ■
page 443



□ □ ■
page 443



□ □ ■
page 443



□ ■ ■
page 445



□ ■ ■
page 445



□ ■ ■
page 445



□ ■ ■
page 445



built in wall lights





YVETTE I

- aluminium diecast
- dimensions L x W x H: 107 x 75 x 64,5 mm

item	colour	colour temperature	light current	price
763005	□ white	ww 3000 K	108 lm	79,95 €
763004	■ anthracite	ww 3000 K	75 lm	79,95 €



suitable mounting accessories for outdoor use from page 827



YVETTE II

- aluminium diecast
- dimensions L x W x H: 75 x 105 x 64,5 mm

item	colour	colour temperature	light current	price
763007	□ white	ww 3000 K	130 lm	79,95 €
763006	■ anthracite	ww 3000 K	100 lm	79,95 €



suitable mounting accessories for outdoor use from page 827



YVETTE III

- aluminium diecast
- dimensions L x W x H: 250 x 87 x 73 mm

item	colour	colour temperature	light current	price
763012	□ white	ww 3000 K	335 lm	139,95 €
763011	■ anthracite	ww 3000 K	219 lm	139,95 €



suitable mounting accessories for outdoor use from page 827



LIGHT BASE II COB OUTDOOR

Recessed wall luminaires in outdoor areas have a slim and elegant appearance and set the scene as light accents for buildings, paths and more. To ensure that the light emission perfectly matches the surroundings, you can choose between four optional cover types and three housing colors each [black, grey, white] for the LIGHT BASE II COB OUTDOOR: stepped, stripe, linear and round. Each shape creates a different light output, allowing for flexible design of outdoor areas.



LIGHT BASE II COB OUTDOOR

- aluminium diecast
- dimensions L x H x W x H: 96 x 96 x 77 mm
- IP65 screwed cable gland
- excl. cover

item	colour	colour temperature	light current	price
763025	grey	3000 K	55 lm	99,95 €

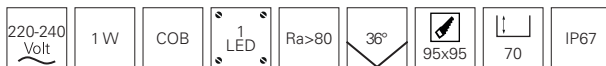

suitable mounting accessories for outdoor use from page 827



With the kind support of Loxone Lichtinstallation Eurotec-Ibiza@fotoeichhorn



cover

930416	<input type="checkbox"/> cover angular step white	100 x 100 x 24 mm	19,95 €
930417	<input type="checkbox"/> cover angular step grey	100 x 100 x 24 mm	19,95 €
930418	<input type="checkbox"/> cover angular step black	100 x 100 x 24 mm	19,95 €
930419	<input type="checkbox"/> cover angular stripe white	100 x 100 x 24 mm	19,95 €
930414	<input type="checkbox"/> cover angular stripe grey	100 x 100 x 24 mm	19,95 €
930420	<input type="checkbox"/> cover angular stripe black	100 x 100 x 24 mm	19,95 €
930421	<input type="checkbox"/> cover angular linear white	100 x 100 x 24 mm	19,95 €
930422	<input type="checkbox"/> cover angular linear grey	100 x 100 x 24 mm	19,95 €
930415	<input type="checkbox"/> cover angular linear black	100 x 100 x 24 mm	19,95 €
930413	<input type="checkbox"/> cover angular round white	100 x 100 x 24 mm	19,95 €
930423	<input type="checkbox"/> cover angular round grey	100 x 100 x 24 mm	19,95 €
930424	<input type="checkbox"/> cover angular round black	100 x 100 x 24 mm	19,95 €

LIGHT BASE III OUTDOOR

Recessed wall luminaires in outdoor areas have a slim and elegant appearance and set the scene as light accents for buildings, paths and more. To ensure that the light emission perfectly matches the surroundings, you can choose between four optional cover types and three housing colours each [black, grey, white] for the LIGHT BASE III OUTDOOR: stepped, stripe, angled and rounded angled. Each shape creates a different light output, allowing for flexible design of outdoor areas.



LIGHT BASE III OUTDOOR

- aluminium diecast
- dimensions L x H x W x H: 245 x 85 x 78 mm
- IP65 screwed cable gland
- excl. cover

item	colour	colour temperature	light current	price
763026	■ black	ww 3000 K	88 lm	119,95 €



suitable mounting accessories for outdoor use from page 827



With the kind support of Loxone Lichtinstallation Eurotec-lbiza@fotoeichhorn

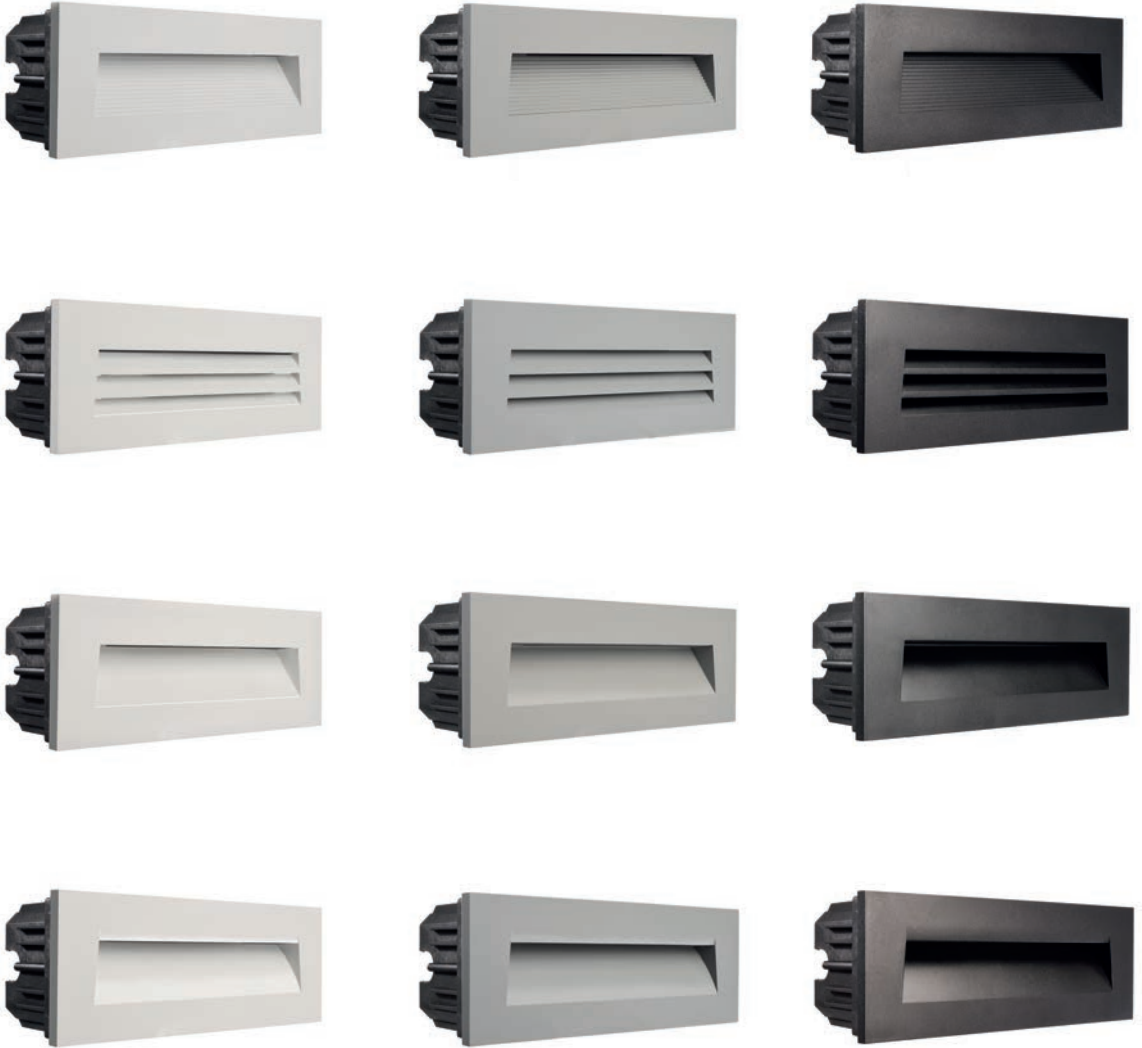

cover

930461	 cover step white	250 x 90 x 24 mm	59,95 €
930468	 cover step grey	250 x 90 x 24 mm	59,95 €
930469	 cover step black	250 x 90 x 24 mm	59,95 €
930470	 cover stripe white	250 x 90 x 24 mm	59,95 €
930471	 cover stripe grey	250 x 90 x 24 mm	59,95 €
930472	 cover stripe black	250 x 90 x 24 mm	59,95 €
930473	 cover angled white	250 x 90 x 24 mm	59,95 €
930474	 cover angled grey	250 x 90 x 24 mm	59,95 €
930475	 cover angled black	250 x 90 x 24 mm	59,95 €
930476	 cover rounded white	250 x 90 x 24 mm	59,95 €
930477	 cover rounded grey	250 x 90 x 24 mm	59,95 €
930478	 cover rounded black	250 x 90 x 24 mm	59,95 €



page 448



spherical lamps





SPHERICAL LAMP

- polyethylene [LLDPE]
- dimmable via optional illuminants
- ready to plug in with 3m connection cable and IP44 contour plug
- incl. ground spike



item	colour	dimensions Ø	power	price
836011	<input type="checkbox"/> white	300 mm	max. 20 W	139,95 €
836930	<input type="checkbox"/> white	400 mm	max. 42 W	169,59 €
836014	<input type="checkbox"/> white	500 mm	max. 42 W	199,95 €
836931	<input type="checkbox"/> white	600 mm	max. 42 W	319,95 €
836958	<input type="checkbox"/> white	800 mm	max. 42 W	519,25 €



suitable illuminants on page 803-805

suitable energy distributors/plug-in socket towers on page 453-459





■ page 453



■ page 453



■ page 455



■ page 455



■ □ page 457



■ □ page 459



energy distributor





SOCKET TOWER

Sometimes it takes a little more than simply »just« light. With our socket tower, available with and without light, we are closing another gap in our range. Make your garden even more flexible – of course in proven DEKO-LIGHT quality at a fair price.



IP67 connection box with double M20 cable gland suitable for e.g. underground cables 3x1,5mm², 5x1,5mm², 3x2,5mm²



total load max. 3680 W



SOCKET TOWER

- aluminium diecast
- dimensions L x H x Ø: 400 x 100 mm
- incl. 2 outlets [total load max. 3650 W]

item	colour	price
733055	■ dark grey	119,95 €

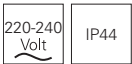

suitable mounting accessories for outdoor use from page 827
RF-smart Outdoor 230V Triac Dimmer/Switch IP67 on page 764



SOCKET TOWER ILLUMINATED

- aluminium diecast
- dimensions L x H x Ø: 478 x 100 mm
- luminaire can be switched separately [separate L]
- incl. 2 outlets [total load max. 3650 W]

item	colour	colour temperature	light current	price
733054	■ dark grey	■ 3000 K	150 lm	169,95 €

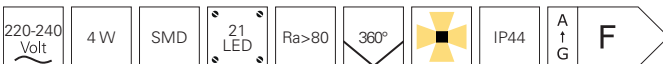

suitable mounting accessories for outdoor use from page 827
RF-smart Outdoor 230V Triac Dimmer/Switch IP67 on page 764





PUKA MANA

A garden is pure nature – and yet it needs electricity in many places. With the new PUKA MANA, you can flexibly tap power to operate lawn mowers and other garden tools or simply charge your e-bike or smartphone. The PUKA MANA ILLUMINATED puts the [light] crown on the whole thing and provides thanks to E27-socket for changeable lighting moods. Both models have two socket locations and are particularly easy to install using our multi-outdoor cable connectors. In addition, the well thought-out cable routing ensures a clean look.



easy installation thanks to IP68 cable connector suitable for underground cables 3x1.5mm², 5x1.5mm², 3x2.5mm², etc.



total load max. 3680 W
door closable with various [angle] plugs when plugged in



PUKA MANA

- aluminium diecast
- dimensions L x W x H : 100 x 100 x 420 mm
- socket L x W: 140 x 140 mm
- incl. 2 outlets [total load max. 3650 W]
- door can be fully closed with angled plug inserted

item	colour	price
733066	 dark grey	199,95 €

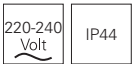



suitable mounting accessories for outdoor use from page 827
RF-smart Outdoor 230V Triac Dimmer/Switch IP67 on page 764



PUKA MANA ILLUMINATED

- aluminium diecast
- dimensions L x W x H : 100 x 100 x 620 mm
- socket L x W: 140 x 140 mm
- luminaire can be switched separately [separate L]
- incl. 2 outlets [total load max. 3650 W]
- door can be fully closed with angled plug inserted

item	colour	colour temperature	price
733067	 dark grey	 ww	259,95 €



suitable illuminants on page 803-805
suitable mounting accessories for outdoor use from page 827
RF-smart Outdoor 230V Triac Dimmer/Switch IP67 on page 764





FACADO SOCKET

The floor lamps of the FACADO series have already been used for some time on paved walkways in the garden area. Now the classically elegant outdoor lights become even more versatile: the FACADO SOCKET includes two socket locations and thus also functions as a practical power distributor in the garden, on terraces or on walkways. In addition, thanks to the E27 socket, the light source can be changed and adapted to the desired lighting mood. The FACADO SOCKET is available in two height versions [65 and 100 cm].



luminaire and socket can be switched separately
exchangeable light source due to E27 base



total load max. 3680 W



double M20 cable gland suitable e.g. for underground
cables 3x1,5mm², 5x1,5mm², 3x2,5mm²



suitable
wall light
page 406
731059



suitable
bollard lights
page 383
730332
733018

FACADO SOCKET

- aluminium diecast
- luminaire can be switched separately [separate L]
- incl. 2 outlets [total load max. 3650 W]

item	colour	dimensions L x W x H	price
733064	■ anthracite	108 x 108 x 650 mm	199,95 €
733065	■ anthracite	108 x 108 x 1000 mm	219,95 €



suitable illuminants on page 803-805
suitable mounting accessories for outdoor use from page 827
RF-smart Outdoor 230V Triac Dimmer/Switch IP67 on page 764



LERNA

The energy distributors of the LERNA series offer a variety of advantages. With a total of two sockets and a total load of 3680 W, they allow you to connect various devices and at the same time provide reliable lighting. The separate switchability of luminaire and sockets gives you maximum control over your lighting environment. The socket cover stays opened for added convenience. In addition, the fully downward directed light ensures efficient lighting without light pollution. The bollard luminaire of the LERNA series is available in two different heights [600 mm and 1000 mm] to meet your specific requirements. With an output of 6 W and 516 lm, the luminaire offers excellent brightness itself.

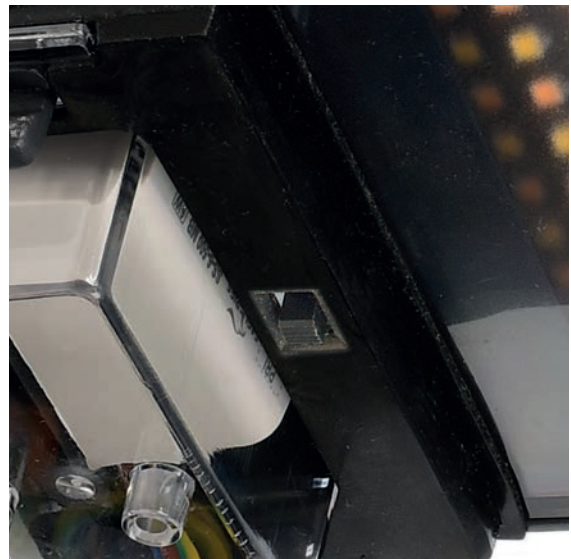



LERNA

- luminaire and socket can be switched separately
- socket cover locks into place when opened
- total power of the sockets 3680 W
- light colour adjustable in two levels
- 100% downward directed light, therefore no light pollution
- aluminium diecast
- luminaire and sockets can be switched separately [separate L]

item	colour	colour temperature	light current	dimensions H	price
733071	■ dark grey	www nw 3000/4000 K	516 lm	600 mm	259,95 €
733070	■ dark grey	www nw 3000/4000 K	516 lm	1000 mm	299,95 €



suitable
bollard lights
page 397
733073
733072

suitable mounting accessories for outdoor use from page 827
RF-smart Outdoor 230V Triac Dimmer/Switch IP67 on page 764



■ ■ □
page 462



□
page 462



■
page 463



■ □
page 464



■ □
page 464



■
page 467



■
page 467



■ □
page 468



■ □
page 469



■ □
page 470



■ □
page 471



surface mounted / ground spike lights





MINI IWW + I AMBER

- aluminium diecast
- dimensions W x H x Ø: 85 x 85 x 42 mm
- socket H x Ø: 10 x 66 mm
- dimmable via optional controller
- incl. 2 m connection cable with WEIPU plug

item	colour	colour temperature	light current	power	Ra	price
131005	silver coloured	3000 K	150 lm	2,60 W	>80	119,95 €
732036	black	3000 K	150 lm	3,10 W	>80	119,95 €
732037	silver coloured	1750 K	57 lm	2,20 W		119,95 €
730238	black	1700 K	65 lm	2,20 W		119,95 €

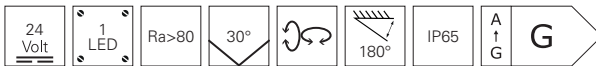

accessories

862230 power supply | 24V | 12,0 W | IP65 **21,95 €**

suitable Weipu cables/connectors on page 817-819

suitable controllers and dimmers from page 763

additional power supplies from page 728

MINI II CW

- aluminium diecast
- dimensions W x H x Ø: 85 x 85 x 42 mm
- socket Ø: 66 mm
- incl. 2 m connection cable with IP44 connector plug

item	colour	colour temperature	light current	price
131006	silver coloured	6000 K	180 lm	129,95 €



suitable energy distributors/plug-in socket towers on page 453-459

suitable mounting accessories for outdoor use from page 827





LOMI

- aluminium
- dimensions L x Ø: 65 x 100 mm
- dimmable via optional illuminants
- incl. 2 m connection cable with IP44 connector plug
- incl. ground spike

item	colour	price
732126	■ black	49,95 €



suitable illuminants on page 800-801

suitable energy distributors/plug-in socket towers on page 453-459



KEID

- aluminium diecast
- dimensions L x H x Ø: 120 x 211 x 75 mm
- socket H x Ø: 37 x 99 mm

item	colour	colour temperature	light current	power EEL	price
731098	■ dark grey	ww 3000 K	800 lm	10 W F	149,95 €
732093	■ dark grey	ww 3000 K	1350 lm	20 W G	149,95 €



suitable mounting accessories for outdoor use from page 827



KEID II

- aluminium diecast
- dimensions L x H x Ø: 120 x 457 x 75 mm
- incl. IP65 connection box

item	colour	colour temperature	light current	power	price
732094	■ dark grey	ww 3000 K	800 lm	10 W	139,95 €
732095	■ dark grey	ww 3000 K	1350 lm	20 W	149,95 €



suitable mounting accessories for outdoor use from page 827





With the kind support of Loxone Lichtinstallation Eurotec-ibiza@fotoeichhorn

COLT

The new COLT series is a real all-rounder in the outdoor area: powerful, freely rotatable and tiltable and equipped with state-of-the-art LED technology. The surface-mounted luminaires thus provide atmospheric lighting concepts in any outdoor installation and also cut a good figure when switched off with their striking design.



COLT 4W COB

- aluminium diecast
- dimensions L x H x Ø: 65 x 120 x 50 mm
- socket H x Ø: 3 x 65 mm
- incl. 2 m connection cable with IP44 connector plug
- incl. 2 glass panes [transparent, milky]
- incl. 1 honeycomb filter



item	colour	colour temperature	light current	price
732104	■ anthracite	www 3000 K	240 lm	139,95 €

220-240 Volt	4 W	COB	1 LED	Ra>80	36°	↻	180°	+ -	IP65/ IP44	A t G	G
--------------	-----	-----	-------	-------	-----	---	------	-----	------------	-------	---

accessories

930426	ground spike L: 170 mm	9,95 €
930428	lens 15°	5,95 €
930430	lens 60°	5,95 €



suitable energy distributors/plug-in socket towers on page 453-459
 suitable mounting accessories for outdoor use from page 827



COLT COB RGBW

- aluminium diecast
- dimensions L x Ø: 65 x 50 mm
- socket H x Ø: 7 x 65 mm
- dimmable via optional controller
- incl. 2 m connection cable with WEIPU plug



item	colour	colour temperature	light current	price
732134	■ anthracite	RGB www 2700 K	92 lm	199,95 €

24 Volt	3,2 W	1 LED	Ra>80	20°	↻	45°	IP65	A t G	G
---------	-------	-------	-------	-----	---	-----	------	-------	---

accessories

862230	power supply 24V 12,0 W IP65	21,95 €
---------------	------------------------------------	----------------

suitable Weipu cables/connectors on page 817-819
 suitable controllers and dimmers from page 763
 additional power supplies from page 729



COLT 8W COB + 8W RGBW

- aluminium diecast
- dimensions L x H x Ø: 65 x 185 x 76,50 mm
- socket H x Ø: 50 x 95 mm
- incl. 2 glass panes [transparent, milky]
- incl. 1 honeycomb filter [only for 732108]

item	colour	colour temperature	light current	beam angle	Ra	voltage	power	price
732108	■ anthracite	WW 3000 K	470 lm	40°	>80	220-240V AC	8,00 W	199,95 €
732127	■ anthracite	RGB WW 3000 K	389 lm	20°		24V DC	8,60 W	299,95 €
732123	■ anthracite	RGB CW 5500 K	485 lm	20°		24V DC	8,60 W	299,95 €



accessories

930441	housing H: 41,5 mm	59,95 €
930426	ground spike L: 170 mm	9,95 €



suitable mounting accessories for outdoor use from page 827

accessories for **732108**

930431	reflector 12°	8,95 €
930432	reflector 22°	8,95 €
930587	connection cable 2950 mm with IP44 230V mains plug	19,95 €



suitable energy distributors/plug-in socket towers on page 453-459

accessories for **732127, 732123**

862230	power supply 24V 12,0 W IP65	21,95 €
872083	power supply 24V 40,0 W IP67	74,95 €

suitable controllers and dimmers from page 763
additional power supplies from page 729



COLT 15W COB + 16W RGBW

- aluminium diecast
- dimensions L x H x Ø: 88 x 220 x 110,50 mm
- socket H x Ø: 56 x 120 mm
- incl. 2 glass panes [transparent, milky]
- incl. 1 honeycomb filter [only for 732109]

item	colour	colour temperature	light current	beam angle	Ra	voltage	power EEL	price
732109	■ anthracite	www 3000 K	1090 lm	40°	>80	220-240V AC	15 W G	249,95 €
732128	■ anthracite	RGB www 3000 K	780 lm	20°		24V DC	16 W G	449,95 €
732124	■ anthracite	RGB CW 5500 K	950 lm	20°		24V DC	16 W F	449,95 €



accessories

- 930442** housing | H: 41,5 mm **69,95 €**
- 930427** ground spike | L: 219 mm **11,95 €**



suitable mounting accessories for outdoor use from page 827

accessories for **732109**

- 930434** reflector 12° **10,95 €**
- 930435** reflector 22° **11,95 €**
- 930587** connection cable 2950 mm with IP44 230V mains plug **19,95 €**



suitable energy distributors/plug-in socket towers on page 453-459

accessories for **732128, 732124**

- 872083** power supply | 24V | 40,0 W | IP67 **74,95 €**

suitable controllers and dimmers from page 763
additional power supplies from page 729



COLT 30W COB + 25W RGBW

- aluminium diecast
- dimensions L x H x Ø: 112 x 260 x 131 mm
- socket H x Ø: 56 x 120 mm
- incl. 2 glass panes [transparent, milky]
- incl. 1 honeycomb filter [only for 732110]

item	colour	colour temperature	light current	beam angle	Ra	voltage	power EEI	price
732110	■ anthracite	WW 3000 K	2320 lm	40°	>80	220-240V AC	30 W G	289,95 €
732129	■ anthracite	RGB WW 3000 K	1140 lm	20°		24V DC	25 W G	499,95 €
732125	■ anthracite	RGB CW 5500 K	1445 lm	20°		24V DC	25 W F	499,95 €



accessories

930442	housing H: 41,5 mm	69,95 €
930427	ground spike L: 219 mm	11,95 €



suitable mounting accessories for outdoor use from page 827

accessories for **732110**

930437	reflector 12°	12,95 €
930438	reflector 22°	12,95 €
930587	connection cable 2950 mm with IP44 230V mains plug	19,95 €



suitable energy distributors/plug-in socket towers on page 452-459

accessories for **732129, 732125**

872083	power supply 24V 40,0 W IP67	74,95 €
872094	power supply 24V 100,0 W IP67	114,95 €

suitable controllers and dimmers from page 763
additional power supplies from page 729



COLT 65W COB + 36W RGBWW

- aluminium diecast
- dimensions L x H x Ø: 162 x 192 x 182 mm
- socket H x Ø: 65 x 160 mm

item	colour	colour temperature	light current	beam angle	Ra	voltage	power	price
732136	■ anthracite	www 3000 K	5260 lm	15°	>90	180-264V AC	65 W	559,95 €
732137	■ anthracite	rgb www 2700 K	1500 lm	20°	>80	24V DC	30 W	679,95 €



accessories for **732136**

930567	reflector 30°	35,95 €
930568	reflector 45°	35,95 €
930569	reflector 70°	35,95 €
930587	connection cable 2950mm with IP44 230V mains plug	19,95 €



suitable energy distributors/plug-in socket towers on page 452-459

accessories for **732137**

930558	housing H: 40,0 mm	89,95 €
930427	ground spike L: 219 mm	11,95 €
872083	power supply 24V 40,0 W IP67	74,95 €
872094	power supply 24V 100,0 W IP67	114,95 €



suitable controllers and dimmers from page 763

additional power supplies from page 729

suitable mounting accessories for outdoor use from page 827



■
page 474



■
page 474



■
page 475



■
page 475



wall washer



CAPH

Despite the linear design, the CAPH wallwasher range is a »round thing«. The wallwashers offer a variety of possibilities to accentuate different objects. Be it the rustic stone wall in warm 3000 K or the modern new building in RGBW. The different optics with symmetrical or asymmetrical beam angles help with positioning.

With the 230 Volt versions, no further accessories are needed. Thanks to the 24 V versions, the CAPH wallwashers can be integrated into all control variants on the market – a »round thing«.



WALL WASHER CAPH SYMMETRIC

- aluminium diecast
- dimensions L x W x H: 1000 x 53,36 x 81,07 mm
- incl. 2 m connection cable with IP44 connector plug

item	colour	colour temperature	light current	price
732079	■ dark grey	ww 3000 K	3000 lm	399,95 €

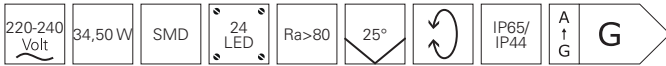

suitable energy distributors/plug-in socket towers on page 453-459
 suitable mounting accessories for outdoor use from page 827

WALL WASHER CAPH SYMMETRIC

- aluminium diecast
- dimensions L x W x H: 1000 x 53,36 x 81,07 mm
- dimmable via optional controller
- incl. 0.5 m connection cable with WEIPU plug
- incl. 0.5 m connection cable with WEIPU plug



item	colour	colour temperature	light current	price
732071	■ dark grey	RGB WW 3000 K	2800 lm	399,95 €



accessories

862164	power supply 24V DC 75,0 W IP20	74,95 €
872085	power supply 24V DC 75,0 W IP67	94,95 €
843502	RF-smart controller starter set RGBW 12/24/48V DC	99,95 €

suitable Weipu cables/connectors on page 817-819
 additional controller and dimmer from page 763
 additional power supplies from page 730



WALL WASHER CAPH ASYMMETRIC

- aluminium diecast
- dimensions L x W x H: 1000 x 53,36 x 81,07 mm
- incl. 2 m connection cable with IP44 connector plug

item	colour	colour temperature	light current	price
732080	■ dark grey	■ 3000 K	2580 lm	399,95 €



suitable energy distributors/plug-in socket towers on page 453-459
 suitable mounting accessories for outdoor use from page 827



WALL WASHER CAPH ASYMMETRIC

- aluminium diecast
- dimensions L x W x H: 1000 x 53,36 x 81,07 mm
- dimmable via optional controller
- incl. 0.5 m connection cable with WEIPU plug
- incl. 0.5 m connection cable with WEIPU plug

item	colour	colour temperature	light current	price
732072	■ dark grey	■ 3000 K	2480 lm	399,95 €



accessories

862164	power supply 24V DC 75,0 W IP20	74,95 €
872085	power supply 24V DC 75,0 W IP67	94,95 €
843502	RF-smart controller starter set RGBW 12/24/48V DC	99,95 €

suitable Weipu cables/connectors on page 817-819
 additional controller and dimmer from page 763
 additional power supplies from page 730



■ □
page 478



■ □
page 478



■ □
page 479



□ □
page 480



□
page 480



□
page 482



■ □
page 483



□ □
page 483



□
page 484

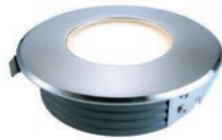

□
page 485



□
page 485



□
page 486



□
page 486



□
page 488



□
page 489



□
page 489



□
page 491

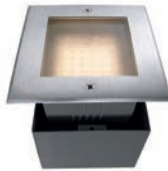

□
page 491



□
page 490



□
page 490



□
page 492



□
page 492



□
page 493



□
page 493



□
page 494



□
page 494



□
page 495



□
page 495



■
page 496



■
page 496



■
page 497



□ □
page 498



□ □
page 499



□ □
page 499



□ □
page 500

ground recessed lights

ATON, PHAKT UND PAVO

Simple and good – with their robust construction, the ATON, PHAKT and PAVO series provide elegant recessed floor lighting at a low price. The interchangeable light sources allow an individual lighting solution with vision.



ATON

- stainless steel, aluminium diecast
- dimmable via optional illuminants

item	colour		dimensions H x Ø / L x W	price
730474	silver coloured brushed	round	111 x 97 mm	54,95 €
730475	silver coloured brushed	square	111 x 97 x 97 mm	54,95 €



suitable illuminants on page 800-801

suitable mounting accessories for outdoor use from page 827



PHAKT

- stainless steel
- dimmable via optional illuminants

item	colour		dimensions H x Ø / L x W	price
730476	silver coloured brushed	round	156 x 136 mm	64,95 €
730477	silver coloured brushed	square	156 x 136 x 136 mm	64,95 €



suitable illuminants on page 803-805

suitable mounting accessories for outdoor use from page 827



PAVO

- stainless steel, aluminium diecast
- swivelling insert
- dimmable via optional illuminants

item	colour		dimensions H x Ø / L x W	price
730478	silver coloured brushed	round	156 x 139 mm	109,95 €
730479	silver coloured brushed	square	156 x 139 x 139 mm	109,95 €

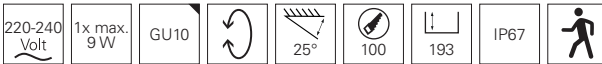

suitable illuminants on page 800-801

suitable mounting accessories for outdoor use from page 827





BASIC IWW

- stainless steel / aluminium diecast
- dimmable via optional controller
- incl. 0.5 m connection cable with WEIPU plug

item	colour	colour temperature	light current	dimensions H x Ø / L x W	price
730339	silver coloured brushed	3000 K	15 lm round	65 x 45 mm	79,95 €
730340	silver coloured brushed	3000 K	14 lm square	65 x 45 x 45 mm	69,95 €

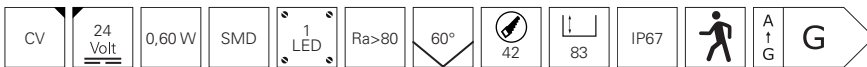

accessories

862230	power supply 24V DC 12,0 W IP65	21,95 €
872083	power supply 24V 40,0 W IP67	74,95 €
843501	RF-smart controller starter set single 12/24/48V	99,95 €

suitable Weipu cables/connectors on page 817-819
 additional controller and dimmer from page 763
 additional power supplies from page 730



ALZIRR II

- stainless steel / aluminium diecast
- dimensions H x Ø: 82,50 x 55 mm
- dimmable via optional controller
- incl. 1 m connection cable with WEIPU plug

item	colour	colour temperature	light current	price
730470	silver coloured brushed	3000 K	150 lm	99,95 €



accessories

862230	power supply 24V DC 12,0 W IP65	21,95 €
872083	power supply 24V 40,0 W IP67	74,95 €
843501	RF-smart controller starter set single 12/24/48V	99,95 €

suitable Weipu cables/connectors on page 817-819
 additional controller and dimmer from page 763
 additional power supplies from page 730





FORNAC

- stainless steel / aluminium diecast
- dimensions H x Ø: 80 x 55 mm
- asymmetric
- dimmable via optional controller
- incl. 1 m connection cable with WEIPU plug [male]



item	colour	colour temperature	light current	price
730447	silver coloured brushed	3000 K	110 lm	119,95 €

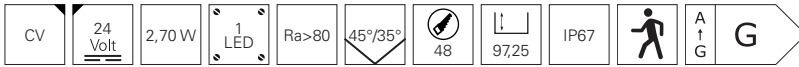

accessories

862230	power supply 24V DC 12,0 W IP65	21,95 €
872083	power supply 24V 40,0 W IP67	74,95 €
843501	RF-smart controller starter set single 12/24/48V	99,95 €

suitable Weipu cables/connectors on page 817-819
 additional controller and dimmer from page 763
 additional power supplies from page 730

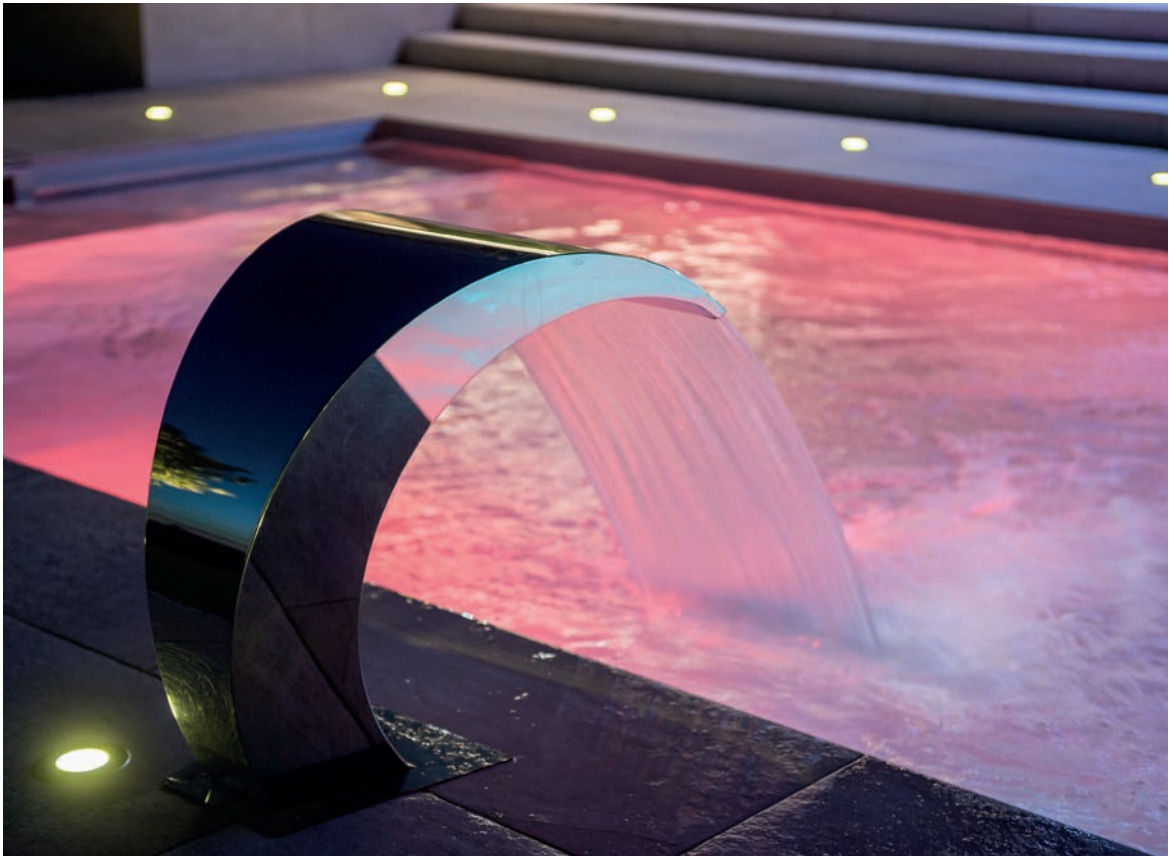

With the kind support of Licht von Klein / www.licht-von-klein.de



NC COB I

- aluminium diecast
- incl. 0,5 m connection cable with protected junction box

item	colour	colour temperature	light current	dimensions H x Ø / L x W	price
730439	black	3000 K	520 lm round	90 x 63 mm	179,95 €
730438	black	3000 K	520 lm square	90 x 63 x 63 mm	179,95 €

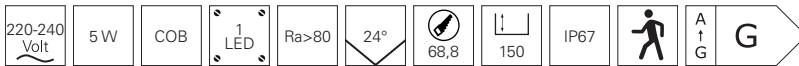

suitable mounting accessories for outdoor use from page 827



EASY COB III WW

- stainless steel / aluminium diecast
- dimensions H x Ø: 96 x 70 mm
- dimmable via optional controller
- incl. 1 m connection cable with WEIPU plug

item	colour	colour temperature	light current	dimensions H x Ø / L x W	price
730469	silver coloured brushed	3000 K	330 lm round	96 x 70 mm	149,95 €
730468	silver coloured brushed	3000 K	330 lm square	96 x 70 x 70 mm	149,95 €



accessories

862230	power supply 24V DC 12,0 W IP65	21,95 €
872083	power supply 24V 40,0 W IP67	74,95 €
843501	RF-smart controller starter set single 12/24/48V	99,95 €

suitable Weipu cables/connectors on page 817-819
 additional controller and dimmer from page 763
 additional power supplies from page 730



PEACOCK

- stainless steel / aluminium diecast
- dimensions H x Ø: 43 x 58 mm
- incl. 0,5 m connection cable with protected junction box



item	colour	colour temperature	light current	price
730459	silver coloured brushed	3000 K	150 lm	109,95 €

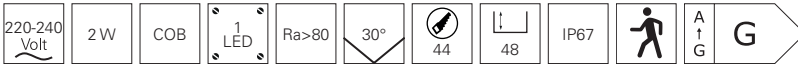

suitable mounting accessories for outdoor use from page 827



With the kind support of Alpbatherme Waldbronn / Ziegler Technics



FLAT III WW

- stainless steel / aluminium diecast
- dimensions H x Ø: 42 x 116 mm
- incl. 0,5 m connection cable

item	colour	colour temperature	light current	price
730336	<input type="checkbox"/> silver coloured brushed	ww 3000 K	25 lm	149,95 €



suitable mounting accessories for outdoor use from page 827



FLAT II

- stainless steel / aluminium diecast
- dimensions H x Ø: 42 x 116 mm
- incl. 0,5 m connection cable

item	colour	colour temperature	light current	price
100111	<input type="checkbox"/> silver coloured brushed	ww 3000 K	400 lm	189,95 €
100112	<input type="checkbox"/> silver coloured brushed	cw 6000 K	450 lm	189,95 €



suitable mounting accessories for outdoor use from page 827



FLAT I WW

- stainless steel / aluminium diecast
- dimensions H x Ø: 38 x 173 mm
- incl. 0,5 m connection cable

item	colour	colour temperature	light current	price
100114	silver coloured brushed	3000 K	860 lm	259,95 €



suitable mounting accessories for outdoor use from page 827



FLAT I RGB

- stainless steel / aluminium diecast
- dimensions H x Ø: 38 x 173 mm
- dimmable via optional controller
- incl. 0.5 m connection cable with WEIPU plug

item	colour	colour temperature	light current	price
100116	silver coloured brushed		510 lm	299,95 €

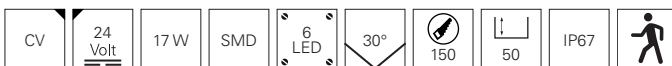

accessories

872083	power supply 24V 40,0 W IP67	74,95 €
843502	RF-smart controller starter set RGB 12/24/48V	99,95 €

suitable Weipu cables/connectors on page 817-819
 additional controller and dimmer from page 763
 additional power supplies from page 730





TALL COB I WW

- stainless steel / aluminium diecast
- dimensions H x Ø: 102 x 116 mm
- incl. 0,5 m connection cable

item	colour	colour temperature	light current	price
730211	 silver coloured brushed	 3000 K	720 lm	179,95 €



suitable mounting accessories for outdoor use from page 827



With the kind support of Licht von Klein / www.licht-von-klein.de



GROUND RECESSED LIGHT II WW

- stainless steel / aluminium diecast
- dimensions H x Ø: 102 x 116 mm
- incl. 0,5 m connection cable

item	colour	colour temperature	light current	price
730255	silver coloured brushed	3000 K	280 lm	169,95 €



suitable mounting accessories for outdoor use from page 827



GROUND RECESSED LIGHT I WW

- stainless steel / aluminium diecast
- dimensions H x Ø: 102 x 116 mm
- dimmable via optional controller
- incl. 1 m connection cable with WEIPU plug

item	colour	colour temperature	light current	price
100133	silver coloured brushed	3000 K	720 lm	179,95 €



accessories

862230	power supply 24V DC 12,0 W IP65	21,95 €
872083	power supply 24V 40,0 W IP67	74,95 €
843501	RF-smart controller starter set single 12/24/48V	99,95 €

suitable Weipu cables/connectors on page 817-819
 additional controller and dimmer from page 763
 additional power supplies from page 730

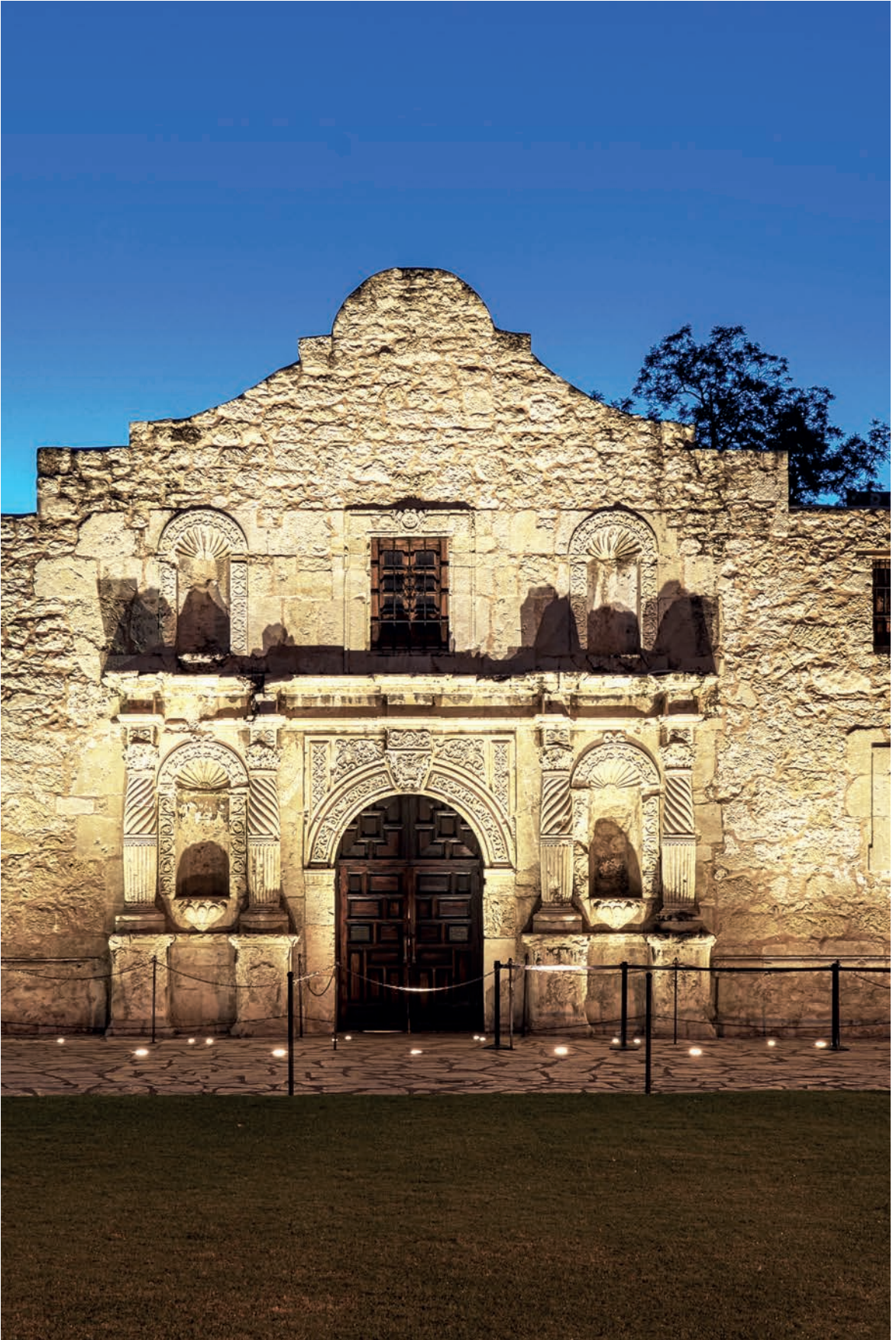



SQUARE COB I WW

- stainless steel / aluminium diecast
- dimensions L x W x H: 125 x 125 x 75 mm
- incl. 0,5 m connection cable

item	colour	colour temperature	light current	price
730209	silver coloured brushed	3000 K	700 lm	169,95 €



suitable mounting accessories for outdoor use from page 827



SQUARE II WW

- stainless steel / aluminium diecast
- dimensions L x W x H: 125 x 125 x 75 mm
- incl. 0,5 m connection cable
- incl. 2 glass panes [Prisma, white]

item	colour	colour temperature	light current	price
730248	silver coloured brushed	3000 K	160 lm	179,95 €

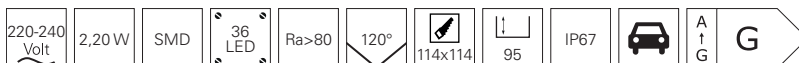

suitable mounting accessories for outdoor use from page 827



GROUND RECESSED LIGHT

- stainless steel / aluminium diecast
- dimensions H x Ø: 111 x 173 mm
- asymmetric
- incl. 0,5 m connection cable

item	colour	colour temperature	light current	price
730289	silver coloured brushed	3000 K	700 lm	249,95 €



suitable mounting accessories for outdoor use from page 827



HP IV WW

- stainless steel / aluminium diecast
- dimensions H x Ø: 111 x 173 mm
- asymmetric
- dimmable via optional controller
- incl. 0.5 m connection cable with WEIPU plug

item	colour	colour temperature	light current	price
730296	silver coloured brushed	3000 K	800 lm	249,95 €



accessories

872083	power supply 24V 40,0 W IP67	74,95 €
843501	RF-smart controller starter set single 12/24/48V	99,95 €

suitable Weipu cables/connectors on page 817-819
 additional controller and dimmer from page 763
 additional power supplies from page 730



With the kind support of Licht von Klein / www.licht-von-klein.de



COB 12 SOFT WW

- stainless steel / aluminium diecast
- dimensions L x Ø: 128 x 173 mm
- incl. 0,5 m connection cable
- incl. honeycomb filter

item	colour	colour temperature	light current	price
730420	silver coloured brushed	3000 K	900 lm	419,95 €

--	--	--	--	--	--	--	--	--	--	--	--

suitable mounting accessories for outdoor use from page 827



COB 25 SOFT WW

- stainless steel / aluminium diecast
- dimensions L x Ø: 190 x 250 mm
- incl. 0,5 m connection cable
- incl. honeycomb filter

item	colour	colour temperature	light current	price
730421	silver coloured brushed	3000 K	1650 lm	579,95 €

--	--	--	--	--	--	--	--	--	--	--	--

suitable mounting accessories for outdoor use from page 827



SOFT FLEX 7

- stainless steel / aluminium diecast
- dimensions H x Ø: 128 x 173 mm
- radiation direction adjustable
- incl. 1 m connection cable
- incl. honeycomb filter

item	colour	colour temperature	light current	price
730267	silver coloured brushed	3000 K	480 lm	349,95 €

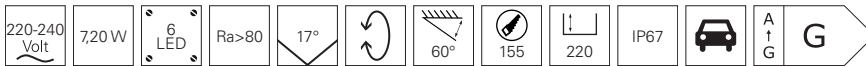

suitable mounting accessories for outdoor use from page 827



SOFT FLEX 18

- stainless steel / aluminium diecast
- dimensions L x Ø: 190 x 250 mm
- incl. 1 m connection cable
- incl. honeycomb filter

item	colour	colour temperature	light current	price
730266	silver coloured brushed	3000 K	770 lm	599,95 €

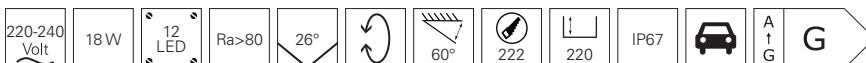

suitable mounting accessories for outdoor use from page 827



EASY SQUARE II RGB

- stainless steel / aluminium diecast
- dimensions L x W x H: 55 x 55 x 99 mm
- dimmable via optional controller
- incl. 0.5 m connection cable with WEIPU plug



item	colour	colour temperature	light current	price
730244	silver coloured brushed		80 lm	179,95 €



accessories

872083	power supply 24V 40,0 W IP67	74,95 €
843502	RF-smart controller starter set RGB 12/24/48V	99,95 €

suitable Weipu cables/connectors on page 817-819
 additional controller and dimmer from page 763
 additional power supplies from page 730



GROUND RECESSED LIGHT III RGB

- stainless steel / aluminium diecast
- dimensions H x Ø: 102 x 116 mm
- dimmable via optional controller
- incl. 0.5 m connection cable with WEIPU plug



item	colour	colour temperature	light current	price
730276	silver coloured brushed		280 lm	189,95 €

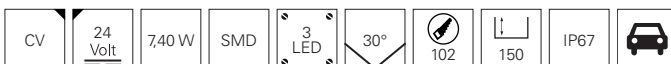

accessories

872083	power supply 24V 40,0 W IP67	74,95 €
843502	RF-smart controller starter set RGB 12/24/48V	99,95 €

suitable Weipu cables/connectors on page 817-819
 additional controller and dimmer from page 763
 additional power supplies from page 730



HOROLOGII

- stainless steel / aluminium diecast
- dimensions H x Ø: 79 x 116 mm
- dimmable via optional controller
- incl. 0.5 m connection cable with WEIPU plug [male]

item	colour	colour temperature	light current	price
730449	<input type="checkbox"/> silver coloured brushed	5700-7000 K	257 lm	199,95 €



accessories

872083	power supply 24V 40,0 W IP67	74,95 €
843502	RF-smart controller starter set RGB 12/24/48V	99,95 €

suitable Weipu cables/connectors on page 817-819
 additional controller and dimmer from page 763
 additional power supplies from page 730



CANUM

- stainless steel / aluminium diecast
- dimensions H x Ø: 111 x 173 mm
- dimmable via optional controller
- incl. 0.5 m connection cable with WEIPU plug

item	colour	colour temperature	light current	price
730454	<input type="checkbox"/> silver coloured brushed		510 lm	349,95 €



accessories

872083	power supply 24V 40,0 W IP67	74,95 €
843502	RF-smart controller starter set RGB 12/24/48V	99,95 €

suitable Weipu cables/connectors on page 817-819
 additional controller and dimmer from page 763
 additional power supplies from page 730



HELIOS I

- aluminium diecast
- dimensions H x Ø: 54 x 210 mm
- socket H x Ø: 25 x 165 mm
- incl. 4 heavy duty anchor

item	colour	colour temperature	light current	price
732143	■ anthracite	ww 3000 K	34 lm	119,95 €

suitable mounting accessories for outdoor use from page 827

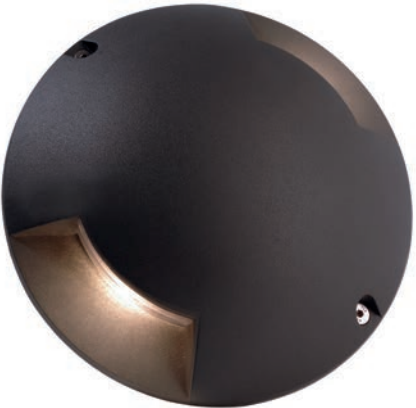

HELIOS II

- aluminium diecast
- dimensions H x Ø: 50 x 210 mm
- socket H x Ø: 7 x 198 mm
- incl. 4 heavy duty anchor

item	colour	colour temperature	light current	price
732049	■ anthracite	ww 3000 K	65 lm	119,95 €

suitable mounting accessories for outdoor use from page 827

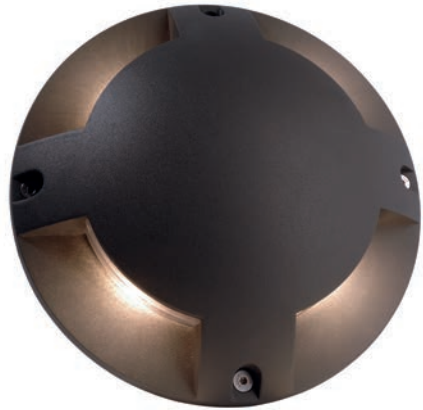

HELIOS IV

- aluminium diecast
- dimensions H x Ø: 50 x 210 mm
- socket H x Ø: 7 x 198 mm
- incl. 4 heavy duty anchor

item	colour	colour temperature	light current	price
732050	 anthracite	 3000 K	150 lm	119,95 €



suitable mounting accessories for outdoor use from page 827

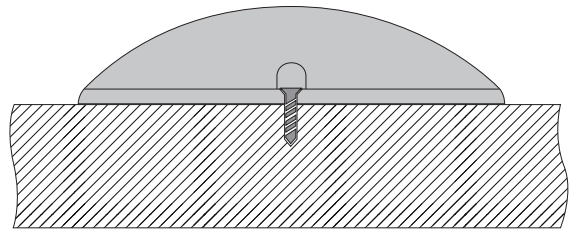
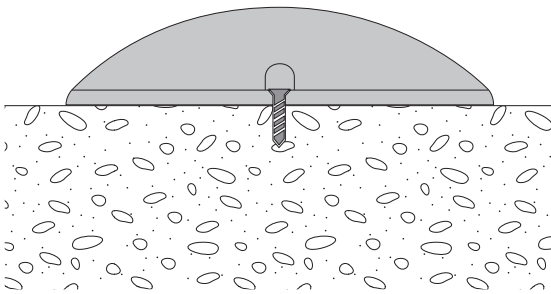



LINE IV 1.9WW + 3.7WW

- stainless steel / aluminium diecast
- incl. 1 m connection cable

item	colour	colour temp.	light current	dimensions L x W x H	cutout L x W	power	light source	price
100108	silver coloured	3000 K	35 lm	195 x 63 x 65 mm	180 x 58 mm	1,90 W	10 LED	159,95 €
100109	silver coloured	3000 K	85 lm	328 x 63 x 65 mm	313 x 58 mm	6,00 W	20 LED	219,95 €

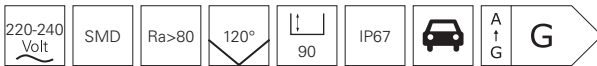

suitable mounting accessories for outdoor use from page 827



With the kind support of Licht von Klein / www.licht-von-klein.de



LINE I WW + II WW

- stainless steel / aluminium diecast
- asymmetric light distribution
- incl. 0,5 m connection cable

item	colour	colour temp.	light current	dimensions L x W x H	cutout L x W	power	light source	price
730292	silver coloured	3000 K	340 lm	195 x 63 x 65 mm	180 x 58 mm	4,50 W	3 LED	179,95 €
730262	silver coloured	3000 K	730 lm	328 x 63 x 65 mm	313 x 58 mm	10,00 W	6 LED	249,95 €

220-240 Volt

Ra>80

45°/35°

90

IP67

A ↑ G

G

suitable mounting accessories for outdoor use from page 827



LINE V WW + VI WW

- stainless steel / aluminium diecast
- incl. 0,5 m connection cable

item	colour	colour temp.	light current	dimensions L x W x H	cutout L x W	power	light source	price
730434	silver coloured	3000 K	1100 lm	549 x 68 x 31.5 mm	524 x 58 mm	16,00 W	12 LED	369,95 €
730432	silver coloured	3000 K	2300 lm	1025 x 68 x 80 mm	1004 x 58 mm	34,00 W	24 LED	599,95 €

220-240 Volt

SMD

Ra>80

20°

80

IP67

A ↑ G

G

suitable mounting accessories for outdoor use from page 827



TABIT

- paving stone look
- suitable for common plaster dimensions
- incl. 30 cm connection cable with open cable ends
- not passable
- Polycarbonat

item	colour	colour temperature	light current	dimensions L x L x H	power EEI	price
730480	<input checked="" type="checkbox"/> colourless satin	3000 K	120 lm	100 x 100 x 68 mm	1,50 W F	29,95 €
730481	<input checked="" type="checkbox"/> colourless satin	3000 K	240 lm	200 x 100 x 68 mm	2,9 W E	59,95 €
730482	<input checked="" type="checkbox"/> colourless satin	3000 K	240 lm	200 x 200 x 68 mm	2,9 W E	99,95 €



suitable mounting accessories for outdoor use from page 827





■ ■ □
page 504



■ □
page 505



■ □
page 506



■ □
page 508



■
page 509



■
page 510



■ □
page 510



floodlight





suitable
power
luminaires
page 331
707130
707138-707033

FLOOD SMD 15 + 30 + 50

- aluminium diecast, glass
- incl. 1,2 m connection cable with IP44 Schuko plug

item	colour	colour temp.	light current	dimensions L x W x H	socket L x W	power	EEL	price
732147	silver	3000 K	1800 lm	170 x 144 x 27 mm	179 x 20 mm	15 W	E	89,95 €
732149	silver	4000 K	1950 lm	170 x 144 x 27 mm	179 x 20 mm	15 W	E	89,95 €
732148	black	3000 K	1325 lm	170 x 144 x 27 mm	179 x 20 mm	15 W	E	89,95 €
732150	silver	3000 K	3600 lm	230 x 192,5 x 40,5 mm	237 x 25 mm	30 W	E	129,95 €
732152	silver	4000 K	3900 lm	230 x 192,5 x 40,5 mm	237 x 25 mm	30 W	D	129,95 €
732151	black	3000 K	3600 lm	230 x 192,5 x 40,5 mm	237 x 25 mm	30 W	E	129,95 €
732153	silver	3000 K	4130 lm	290 x 244 x 40,5 mm	302 x 30 mm	50 W	E	179,95 €
732155	silver	4000 K	4190 lm	290 x 244 x 40,5 mm	302 x 30 mm	50 W	E	179,95 €
732154	black	3000 K	4130 lm	290 x 244 x 40,5 mm	302 x 30 mm	50 W	E	179,95 €



suitable mounting accessories for outdoor use from page 827
suitable energy distributors/plug-in socket towers on page 453-459

ATIK

The surface-mounted luminaires of the ATIK series are real power packs and deliver up to 40,000 lumens. Thanks to their especially flat construction, the ATIK spotlights can be installed in almost any location. The floodlights become even more flexible with the separately available anti-dazzle device and the optional protective front grid.



ATIK

- aluminium diecast, glass
- dimensions L x W x H: 319 x 90 x 411 mm
- incl. 2 m connection cable with IP44 Schuko plug

item	colour	colour temperature	light current	power	light source	EEL	price
732096	■ black	4000 K	21350 lm	150 W	418 LED	D	399,95 €
732097	■ black	4000 K	28450 lm	200 W	320 LED	D	519,95 €
732098	■ black	4000 K	31800 lm	240 W	320 LED	D	579,95 €
732102	■ black	4000 K	39900 lm	300 W	416 LED	E	679,95 €



accessories

- 930410** anti-dazzle device | black | 122 mm **29,95 €**
930411 protective grid metal | black | 57 mm **17,95 €**



suitable mounting accessories for outdoor use from page 827
 suitable energy distributors/plug-in socket towers on page 453-459

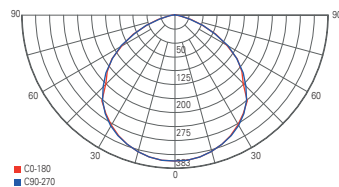

light distribution curve 732096

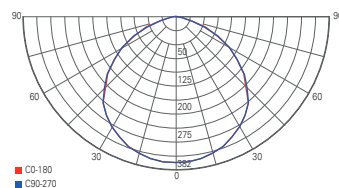

light distribution curve 732097

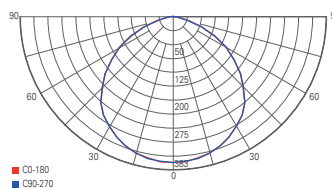

light distribution curve 732098

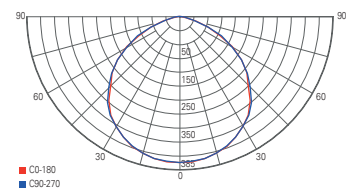

light distribution curve 732102

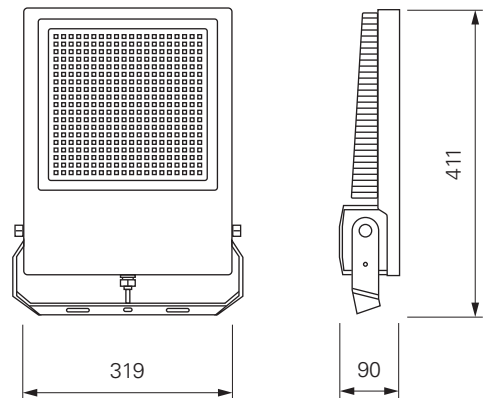



BRACHIUM

- aluminium diecast
- dimensions L x W x H: 316 x 286 x 41 mm
- socket L x W x H: 327 x 28 x 160 mm
- incl. 2 m connection cable with IP44 Schuko plug

item	colour	colour temperature	light current	price
732064	black	3000 K	8100 lm	199,95 €
732105	black	4000 K	8400 lm	199,95 €



suitable mounting accessories for outdoor use from page 827
 suitable energy distributors/plug-in socket towers on page 453-459

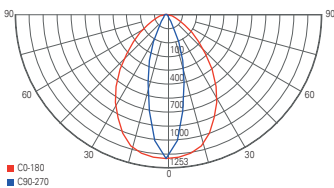
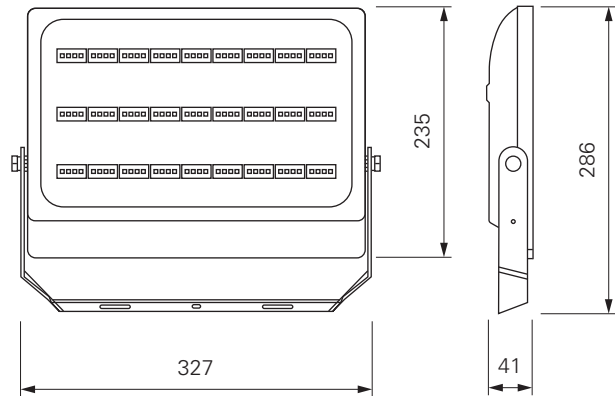

light distribution curve 732064

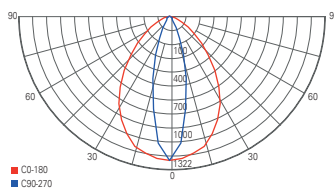

light distribution curve 732105





DEKO-LIGHT RF-SMART FLOOD RGB+CCT RF + ZIGBEE

- aluminium diecast / plastic
- brightness and colour saturation dimmable
- 16 million colours and colour temperature adjustable
- 18 automatic programmes preinstalled
- programme and remote control synchronisation when operating several RF-smart lamps [repeater function]
- controllable with RF-smart radio remote controls [2.4GHz, range approx. 30m, not included in delivery]
- controllable with all Zigbee 3.0 compatible controllers / apps such as Amazon Echo [Alexa], Google Assistant, Tuya [corresponding gateway required, outdoor range up to 100m]
- incl. 1.5 m connection cable with IP44 plug

item	colour	colour temp.	light current	power	dimensions L x W x H	EEL	price
843518	■ anthracite	RGB 2700-6000 K	3300 lm	30 W	167 x 40 x 227 mm	E	249,95 €
843519	■ anthracite	RGB 2700-6000 K	4800 lm	50 W	220 x 48 x 311 mm	F	349,95 €
843520	■ anthracite	RGB 2700-6000 K	10000 lm	100 W	295 x 60 x 403 mm	F	549,95 €



accessories

930659 wall bracket / display arm | black **59,95 €**

matching remote controls and further RF-smart components on page 763

suitable mounting accessories for outdoor use from page 827

suitable energy distributors/plug-in socket towers on page 453-459



With the kind support of Loxone Lichtinstallation Eurotec-Ibiza@fotoeichhorn



DEKO-LIGHT RF-SMART SPOT RGB+CCT RF + ZIGBEE

- aluminium diecast / plastic
- brightness and colour saturation dimmable
- 16 million colours and colour temperature adjustable
- 18 automatic programmes preinstalled
- programme and remote control synchronisation when operating several RF-smart lamps [repeater function]
- controllable with RF-smart radio remote controls [2.4GHz, range approx. 30m, not included in delivery]
- controllable with all Zigbee 3.0 compatible controllers / apps such as Amazon Echo [Alexa], Google Assistant, Tuya [corresponding gateway required, outdoor range up to 100m]
- incl. 1.5 m connection cable with IP44 plug
- incl. ground spike
- very narrow beam angle, ideal for column lighting or similar

item	colour	colour temp.	light current	power	dimensions L x B x H	price
843521	■ anthracite	2700-6000 K	1700 lm	25 W	170 x 65 x 180 mm	239,95 €



accessories

930659 wall bracket / display arm | black **59,95 €**

matching remote controls and further RF-smart components on page 763
 suitable mounting accessories for outdoor use from page 827
 suitable energy distributors/plug-in socket towers on page 453-459

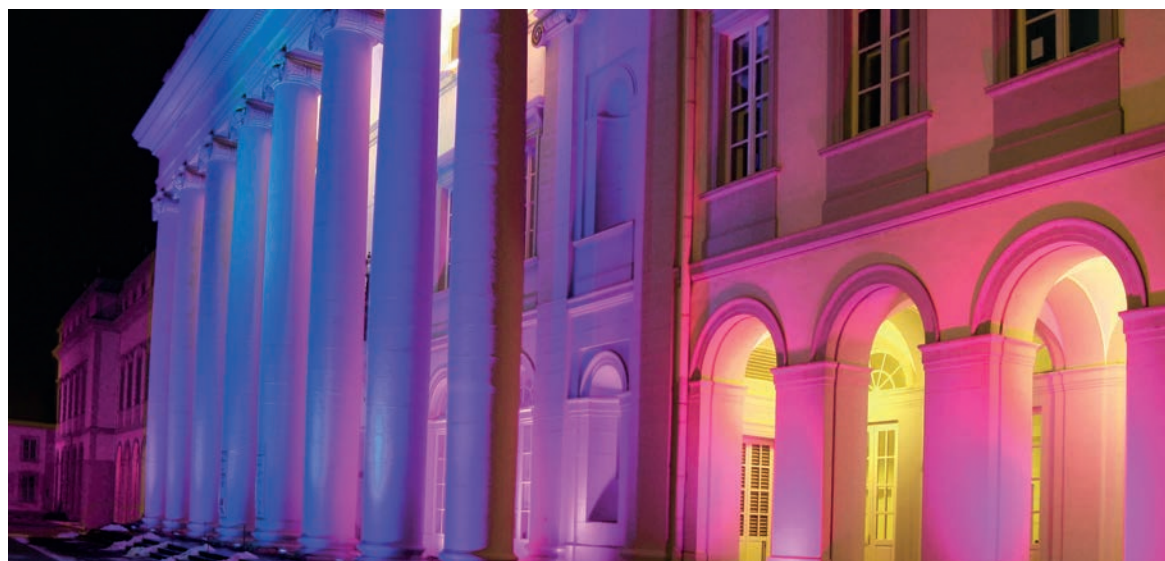

FLOOD RF II -10 RGB

- plastic
- dimensions L x W x H: 133 x 57 x 179 mm
- incl. 2 m connection cable with IP44 connector plug
- incl. radio remote control with approx. 20 m range
- not compatible/controllable with RF-smart system



item	colour	colour temperature	light current	price
732074	■ anthracite	RGB	270 lm	189,95 €



suitable energy distributors/plug-in socket towers on page 453-459
 suitable mounting accessories for outdoor use from page 827



FLOOD RF II -30 RGB + -60 RGB

- plastic
- incl. 2 m connection cable with IP44 connector plug
- incl. radio remote control with approx. 20 m range
- not compatible/controllable with RF-smart system

item	colour	colour temperature	light current	power	beam angle	dimensions L x W x H	price
732075	■ anthracite	RGB	1060 lm	30 W	150°	178 x 81 x 215 mm	299,95 €
732076	■ anthracite	RGB	2100 lm	60 W	120°	200 x 98 x 253 mm	429,95 €



suitable energy distributors/plug-in socket towers on page 453-459
 suitable mounting accessories for outdoor use from page 827

With the kind support of Loxone Lichtinstallation Eurotec-ibiza@fotoeichhorn





□ ■
page 514



■
page 515



display lights





ATIS II

- aluminium diecast
- dimensions L x W: 526 x 144 mm
- socket H x Ø: 40 x 95 mm
- dimmable via phase control or phase cut-off
- rotating and swivelling luminaire head

item	colour	colour temperature	light current	price
688020	white	3000 K	1150 lm	219,95 €
688021	anthracite	3000 K	1150 lm	219,95 €

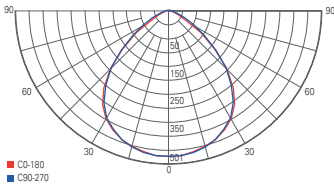
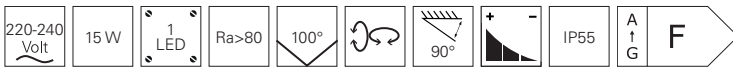

light distribution curve 688020

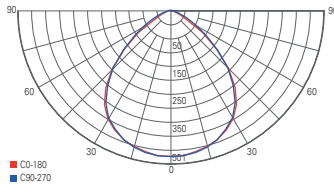

light distribution curve 688021





MOBBY II

- aluminium diecast
- dimensions L x H x Ø: 680 x 100 x 84 mm
- socket H x Ø: 34 x 95 mm
- dimmable via phase control or phase cut-off
- rotating and swivelling luminaire head

item	colour	colour temperature	light current	price
688008	anthracite	3000 K	810 lm	229,95 €

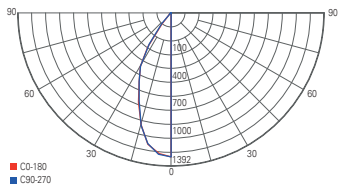

light distribution curve





PLANO

- 520 PLANO luminaire system
- 538 PLANO-profiles

PLANO LUMINAIRE SYSTEM

Whether as a recessed version, surface-mounted ceiling luminaire or pendant luminaire as well as for wall mounting: the PLANO series is more than just another combination of profile and LED strip and is produced entirely in Europe. The linear lighting solutions are based on four different profiles and can be configured individually. Thus, there are hardly any limits to the possible applications - whether in the office, in schools, in private living areas, in stores, showrooms and many more.



INDIVIDUAL SOLUTION

A PLANO profile luminaire always has the same design - and yet it is individual. Inside sits a profile with LED illumination in 2,700, 3,000 or 4,000 K. The surrounding luminaire body is made of extruded aluminum and has an anodized or powder-coated surface. You can individually determine the length, equipment as well as the basic shape of the body, because the PLANO series is an individual lighting solution.

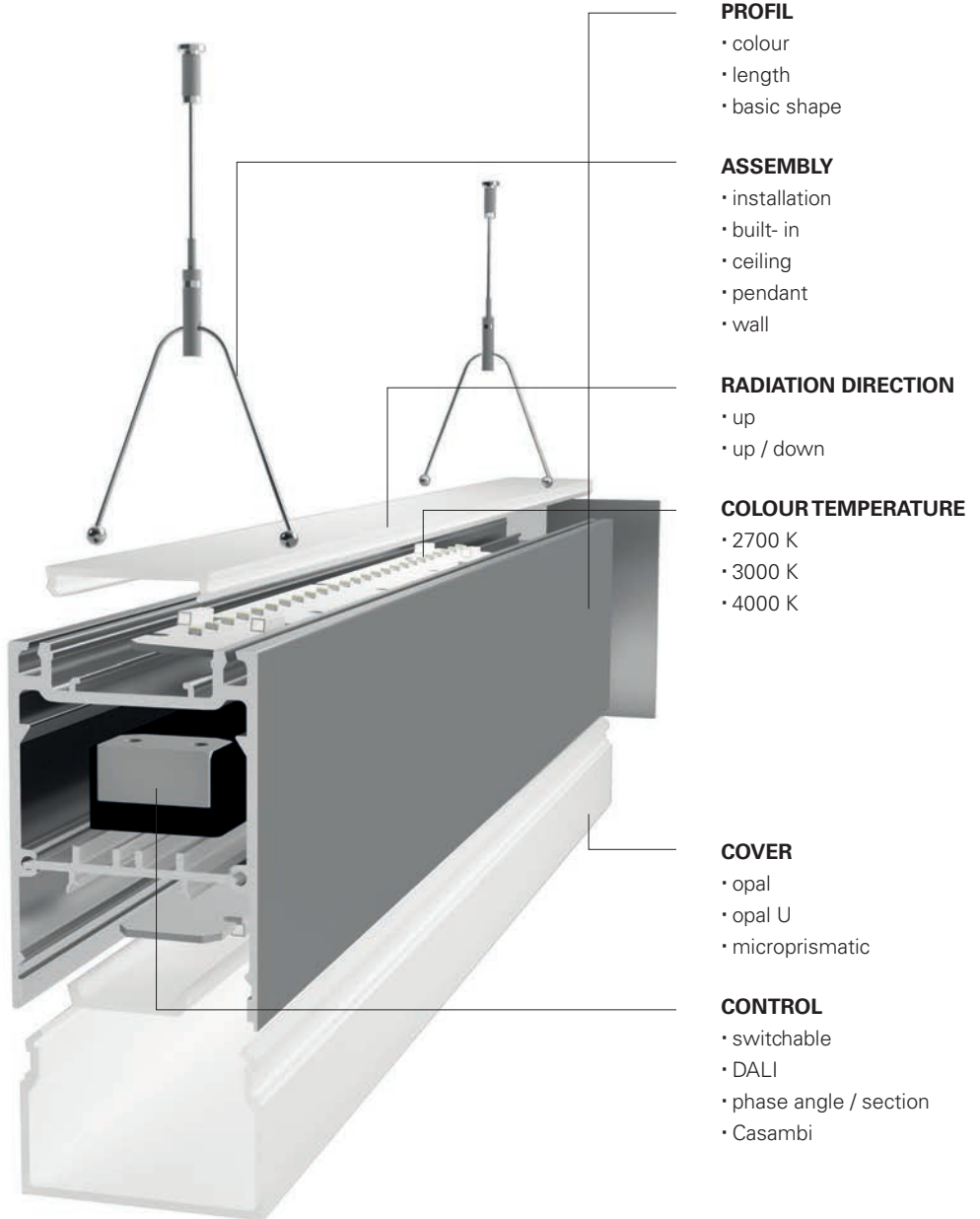



**PLANO DS
luminaire system**

page 524

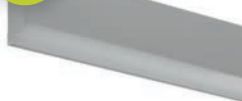

**PLANO ES
luminaire system**

from page 526



**PLANO ES RECESSED
luminaire system**

page 530



**PLANO MS
luminaire system**

from page 532



**PLANO MS RECESSED
luminaire system**

page 534



**PLANO BSH
luminaire system**

page 536



PLANO luminaire system



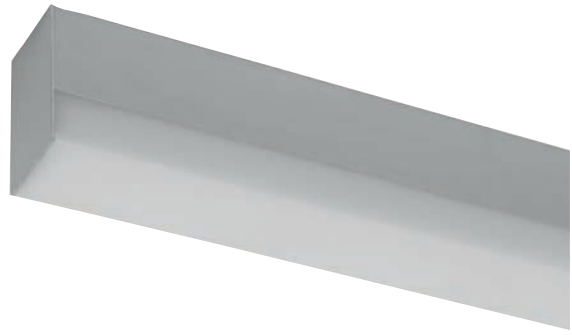
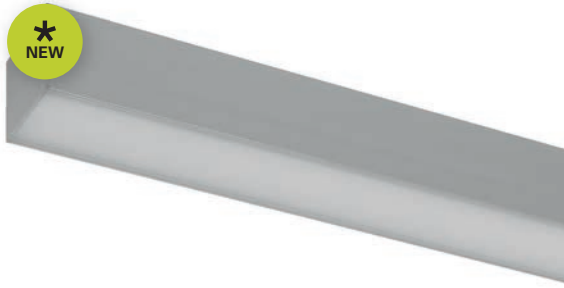

PLANO DS LUMINAIRE SYSTEM

- aluminium die casting
- direct light

assembly				cover			length	radiation dir.		colour	colour temperature			control			
ceiling structure	pendulum	wall structure	ceiling mounting	opal	opal U	microprismatic	individual	down	up+down	individual	2700 K	3000 K	4000 K	switchable	DALI	phase angle/section	Casambi
x	x			x	x	x	x	x		x	x	x	x	x	x	x	x

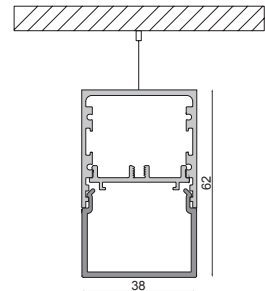
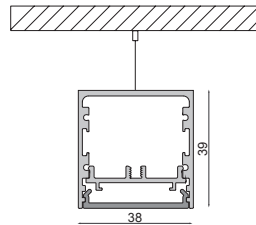
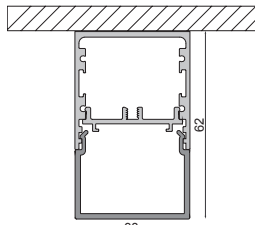
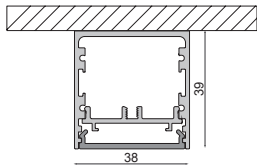
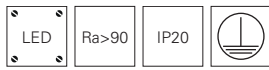

CONFIGURATION EXAMPLE

- DS surface-mounted luminaire | 2400 mm | black
- 74 W
- 3000 K | 6827 lm
- EVG | DALI
- incl. U-cover opal
- incl. end caps

price on demand

Of course, you can configure our PLANO system entirely according to your wishes and circumstances.

with the kind support of WIBU-SYSTEMS AG Karlsruhe



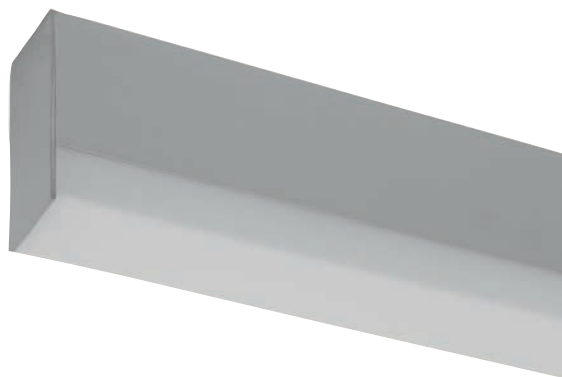
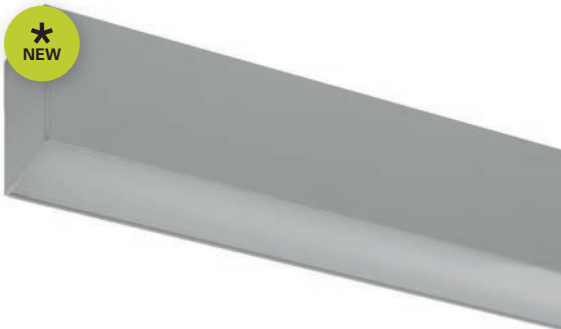

PLANO ES LUMINAIRE SYSTEM

- aluminium die casting
- direct light

assembly				cover			length	radiation dir.		colour	colour temperature			control			
ceiling structure	pendulum	wall structure	ceiling mounting	opal	opal U	microprismatic	individual	down	up+down	individual	2700 K	3000 K	4000 K	switchable	DALI	phase angle/section	Casambi
x	x			x	x	x	x	x	x	x	x	x	x	x	x	x	x

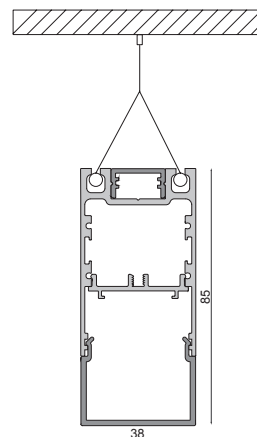
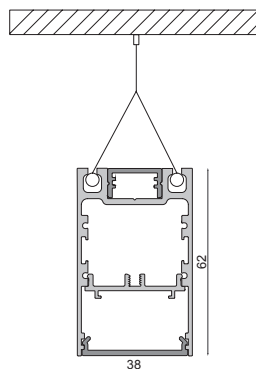
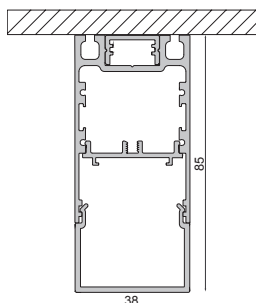
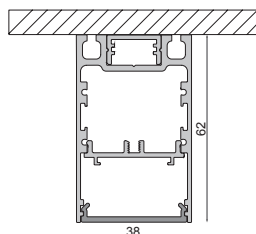
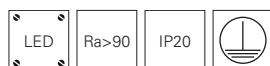

CONFIGURATION EXAMPLE

- ES surface-mounted luminaire | 2400 mm | black
- 74 W
- 3000 K | 5425 lm
- EVG | DALI
- incl. U-cover flat opal
- incl. end caps

price on demand

Of course, you can configure our PLANO system entirely according to your wishes and circumstances.



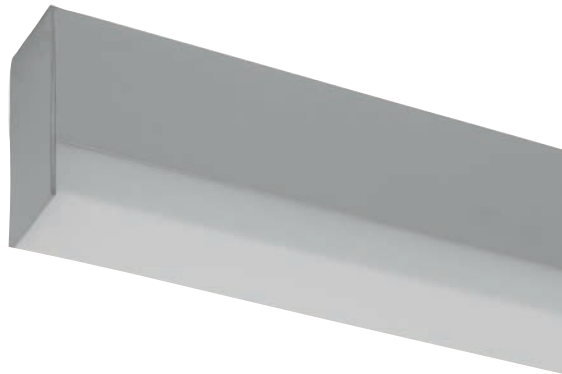
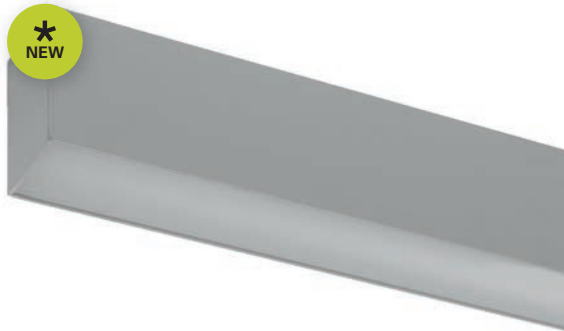

PLANO ES LUMINAIRE SYSTEM

- aluminium die casting
- direct light

assembly				cover			length	radiation dir.		colour	colour temperature			control			
ceiling structure	pendulum	wall structure	ceiling mounting	opal	opal U	microprismatic	individual	down	up+down	individual	2700 K	3000 K	4000 K	switchable	DALI	phase angle/section	Casambi
		X		X	X	X	X	X	X	X	X	X	X	X	X	X	X

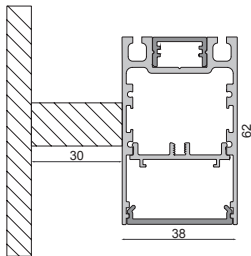
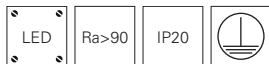

CONFIGURATION EXAMPLE

- ES wall-mounted luminaire | 2400 mm | black
- 97 W
- 3000 K | 7201 lm
- EVG | DALI
- incl. U-cover flat opal
- incl. end caps and wall bracket

price on demand

Of course, you can configure our PLANO system entirely according to your wishes and circumstances.



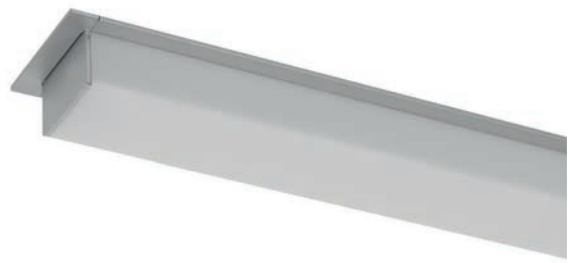
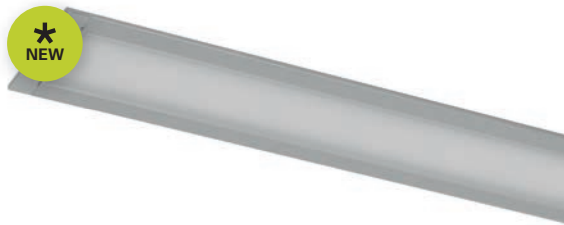

PLANO ES RECESSED LUMINAIRE SYSTEM

- aluminium die casting
- direct light

assembly				cover			length	radiation dir.		colour	colour temperature			control			
ceiling structure	pendulum	wall structure	ceiling mounting	opal	opal U	microprismatic	individual	down	up+down	individual	2700 K	3000 K	4000 K	switchable	DALI	phase angle/section	Casambi
			X	X	X	X	X	X		X	X	X	X	X	X	X	X

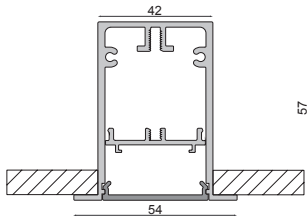
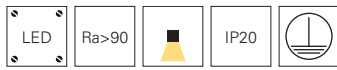

CONFIGURATION EXAMPLE

- ES recessed ceiling luminaire | 2400 mm | black
- 97 W
- 3000 K | 7201 lm
- EVG | DALI
- incl. U-cover flat opal
- incl. end caps and mounting bracket

price on demand

Of course, you can configure our PLANO system entirely according to your wishes and circumstances.



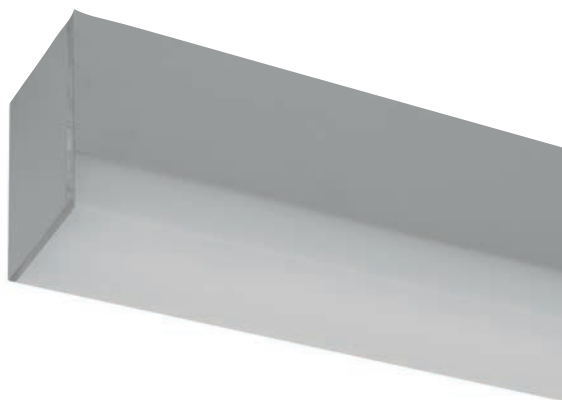
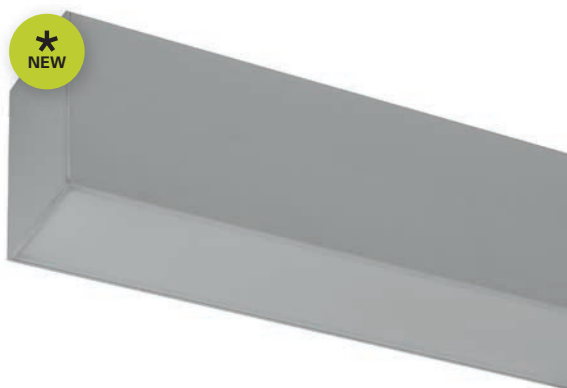

assembly				cover			length	radiation dir.		colour	colour temperature			control			
ceiling structure	pendulum	wall structure	ceiling mounting	opal	opal U	microprismatic	individual	down	up+down	individual	2700 K	3000 K	4000 K	switchable	DALI	phase angle/section	Casambi
x	x			x	x	x	x	x	x	x	x	x	x	x	x	x	x

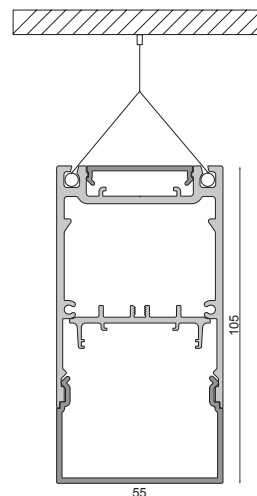
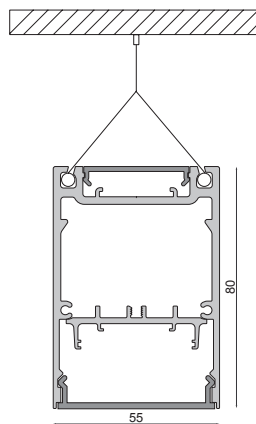
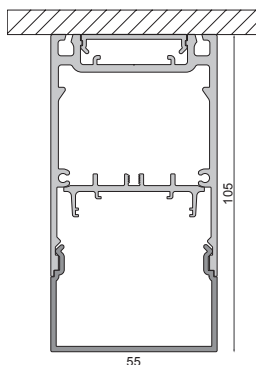
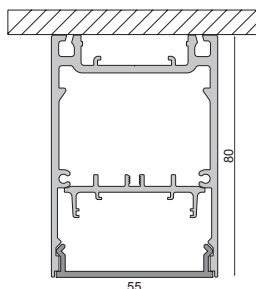
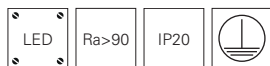

CONFIGURATION EXAMPLE

- MS surface-mounted luminaire | 2400 mm | black
- 74 W
- 3000 K | 6990 lm
- EVG | DALI
- incl. U-cover opal
- incl. end caps

price on demand

Of course, you can configure our PLANO system entirely according to your wishes and circumstances.



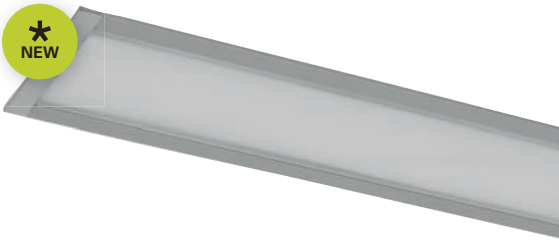

PLANO MS RECESSED LUMINAIRE SYSTEM

- aluminium die casting
- direct light

assembly				cover			length	radiation dir.		colour	colour temperature			control			
ceiling structure	pendulum	wall structure	ceiling mounting	opal	opal U	microprismatic	individual	down	up+down	individual	2700 K	3000 K	4000 K	switchable	DALI	phase angle/section	Casambi
			X	X	X	X	X	X		X	X	X	X	X	X	X	X

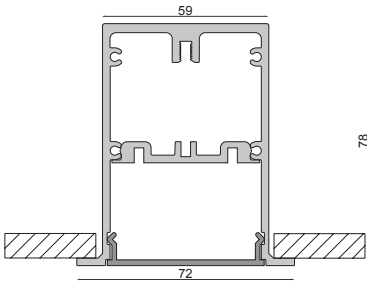

CONFIGURATION EXAMPLE

- MS recessed ceiling luminaire | 2400 mm | black
- 74 W
- 3000 K | 6990 lm
- EVG | DALI
- incl. U-cover opal
- incl. end caps and mounting bracket

price on demand

Of course, you can configure our PLANO system entirely according to your wishes and circumstances.





PLANO BSH LUMINAIRE SYSTEM

- aluminium die casting
- direct light

assembly				cover			length	radiation dir.		colour	colour temperature			control			
ceiling structure	pendulum	wall structure	ceiling mounting	opal	opal U	microprismatic	individual	down	up+down	individual	2700 K	3000 K	4000 K	switchable	DALI	phase angle/section	Casambi
		X		X	X	X	X	X	X	X	X	X	X	X	X	X	X

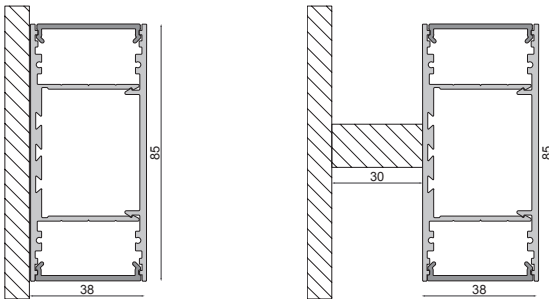
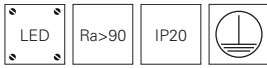

CONFIGURATION EXAMPLE

- BSH wall-mounted luminaire | 2400 mm | black
- 174 W,
- 3000 K | 10822 lm
- EVG | DALI
- incl. U-cover opal
- incl. end caps

price on demand

Of course, you can configure our PLANO system entirely according to your wishes and circumstances.



Foto: Visione.ch

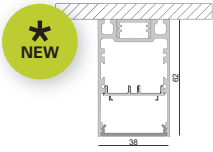

PLANO ES profiles
page 540



PLANO BSH profiles
page 542

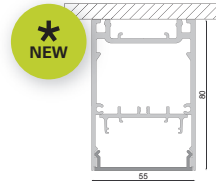

PLANO MS profiles
page 544



PLANO profiles





PLANO ES

- universal luminaire profile
- uplight for LED stripes up to 15 mm wide
- downlight for LED stripes up to 22 mm wide
- incl. LED support

item	colour	dimensions L	price
970572	aluminium anodised	2000 mm	129,95 €
970573	aluminium anodised	2500 mm	159,95 €
970574	black	2000 mm	129,95 €
970575	black	2500 mm	159,95 €

other colours on request

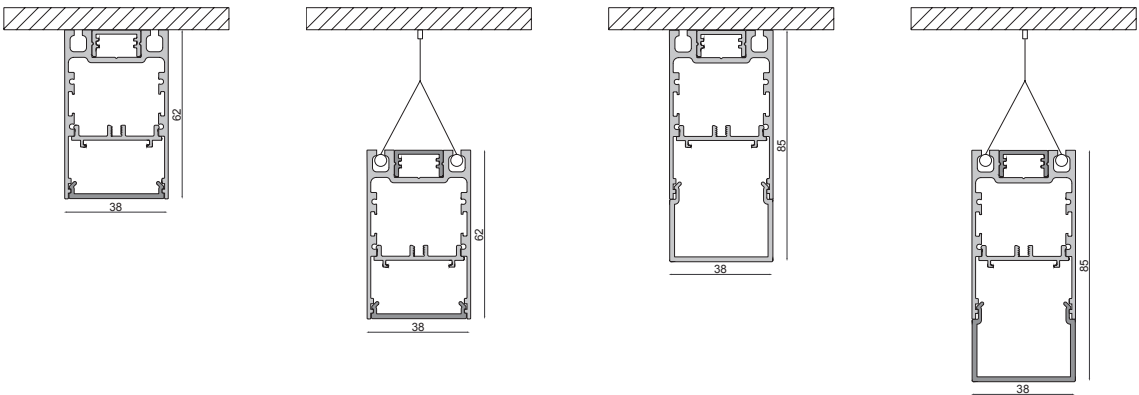



accessories

840192	LED stripe 5m 24V 2700K 66 lm/W 1215 lm/m 18,5 W/m 240 LED/m	164,95 €
840193	LED stripe 5m 24V 3000K 84 lm/W 1605 lm/m 19,0 W/m 240 LED/m	164,95 €
840194	LED stripe 5m 24V 4000K 89 lm/W 1770 lm/m 20,0 W/m 240 LED/m	164,95 €
862124	power supply long-flat 24V 45 W	49,95 €
862094	power supply long-flat 24V 60 W	59,95 €
862126	power supply long-flat 24V 100 W	96,95 €
862173	power supply long-flat 24V 150 W	129,95 €
988095	PLANO ES wire suspension set	49,95 €

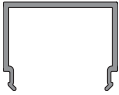

further LED strips in additional light colours [CCT/RGB/RGBW] and wattages as well as dimmable power supply units and controls on request

covers | PMMA [Polymethyl methacrylate]
for Luminaire profile PLANO ES

opal microprismatic

			
2000 mm	988086	39,95 €	
2500 mm	988087	49,95 €	
			
2000 mm	988088	84,95 €	
2500 mm	988089	104,95 €	
			
2000 mm	988090	69,95 €	
2500 mm	988091	84,95 €	

end cap | 1 piece
aluminium

	aluminium anodised	988092	24,95 €
	black	988093	24,95 €



With the kind support of WIBU-SYSTEMS AG Karlsruhe

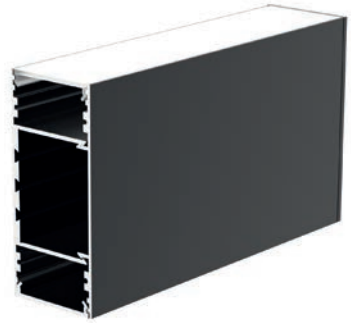
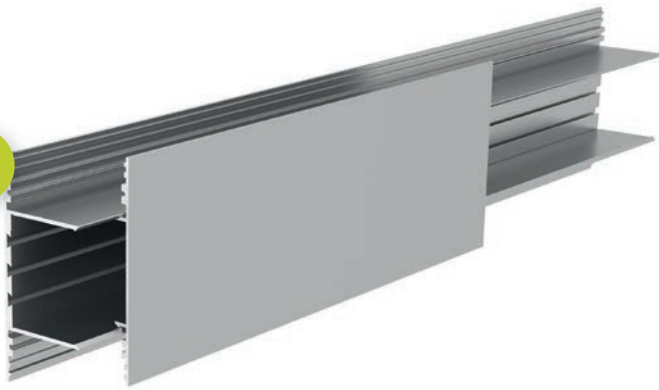

PLANO BSH

- universal luminaire profile
- uplight for LED stripes up to 31 mm wide
- downlight for LED stripes up to 31 mm wide
- incl. LED support

item	colour	dimensions L	price
970584	aluminium anodised	2000 mm	139,95 €
970585	aluminium anodised	2500 mm	169,95 €
970586	black	2000 mm	199,95 €
970587	black	2500 mm	249,95 €

other colours on request

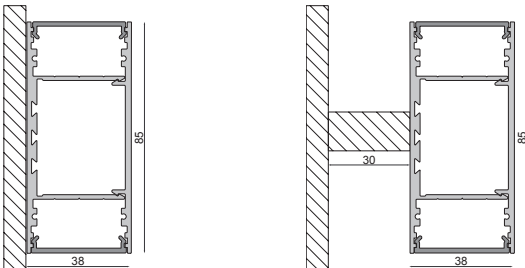



accessories

840192	LED stripe 5m 24V 2700K 66 lm/W 1215 lm/m 18,5 W/m 240 LED/m	164,95 €
840193	LED stripe 5m 24V 3000K 84 lm/W 1605 lm/m 19,0 W/m 240 LED/m	164,95 €
840194	LED stripe 5m 24V 4000K 89 lm/W 1770 lm/m 20,0 W/m 240 LED/m	164,95 €
862124	power supply long-flat 24V 45 W	49,95 €
862094	power supply long-flat 24V 60 W	59,95 €
862126	power supply long-flat 24V 100 W	96,95 €
862173	power supply long-flat 24V 150 W	129,95 €

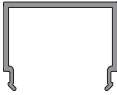

further LED strips in additional light colours [CCT/RGB/RGBW] and wattages as well as dimmable power supply units and controls on request

covers | PMMA [Polymethyl methacrylate]
for luminaire profile PLANO BSH

opal microprismatic

			
2000 mm	988086	39,95 €	
2500 mm	988087	49,95 €	
			
2000 mm	988088	84,95 €	
2500 mm	988089	104,95 €	
			
2000 mm	988090	69,95 €	
2500 mm	988091	84,95 €	

end cap | 1 piece
aluminium

	aluminium anodised	988106	24,95 €
	black	988107	29,95 €



With the kind support of WIBU-SYSTEMS AG Karlsruhe

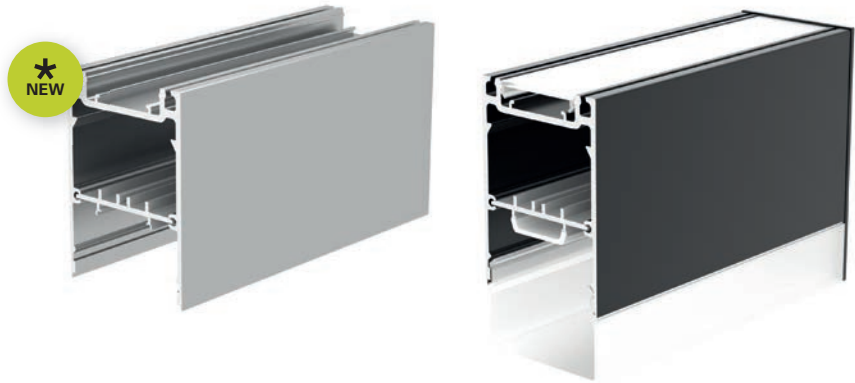

PLANO MS

- universal luminaire profile
- uplight for LED stripes up to 24 mm wide
- downlight for LED stripes up to 24 mm wide
- incl. LED support

item	colour	dimensions L	price
970578	■ aluminium anodised	2000 mm	274,95 €
970579	■ aluminium anodised	2500 mm	339,95 €
970580	■ black	2000 mm	274,95 €
970581	■ black	2500 mm	339,95 €

other colours on request

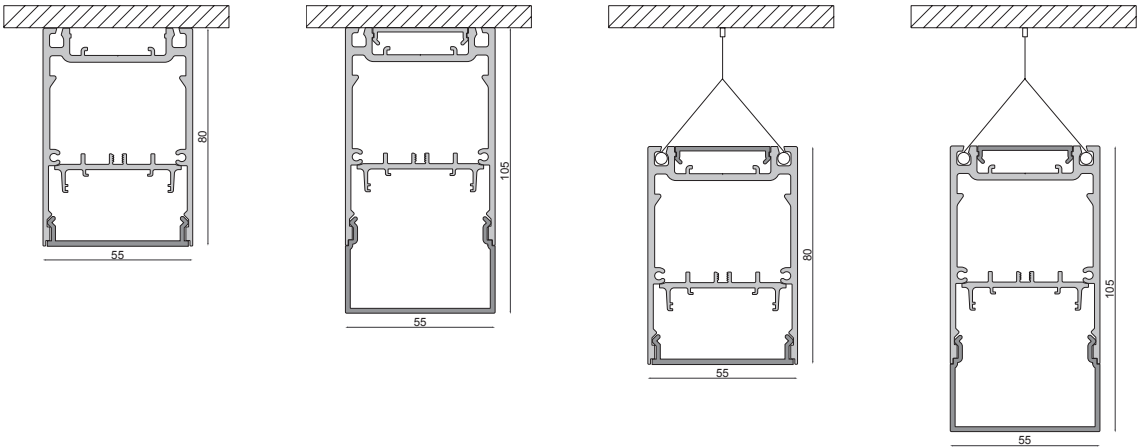

accessories

840192	LED stripe 5m 24V 2700K 66 lm/W 1215 lm/m 18,5 W/m 240 LED/m	164,95 €
840193	LED stripe 5m 24V 3000K 84 lm/W 1605 lm/m 19,0 W/m 240 LED/m	164,95 €
840194	LED stripe 5m 24V 4000K 89 lm/W 1770 lm/m 20,0 W/m 240 LED/m	164,95 €
862124	power supply long-flat 24V 45 W	49,95 €
862094	power supply long-flat 24V 60 W	59,95 €
862126	power supply long-flat 24V 100 W	96,95 €
862173	power supply long-flat 24V 150 W	129,95 €
862265	power supply long-flat 24V 240 W	159,95 €
988105	PLANO ES wire suspension set	49,95 €

further LED strips in additional light colours [CCT/RGB/RGBW] and wattages as well as dimmable power supply units and controls on request

covers | PMMA [Polymethyl methacrylate]
for luminaire profile Plano MS

opal microprismatic



2000 mm	988096	49,95 €
2500 mm	988097	64,95 €





2000 mm	988098	99,95 €
2500 mm	988099	124,95 €



2000 mm	988100	69,95 €
2500 mm	988101	84,95 €

end cap | 1 piece
aluminium

 aluminium anodised	988102	24,95 €
 black	988103	29,95 €

With the kind support of WIBU-SYSTEMS AG Karlsruhe

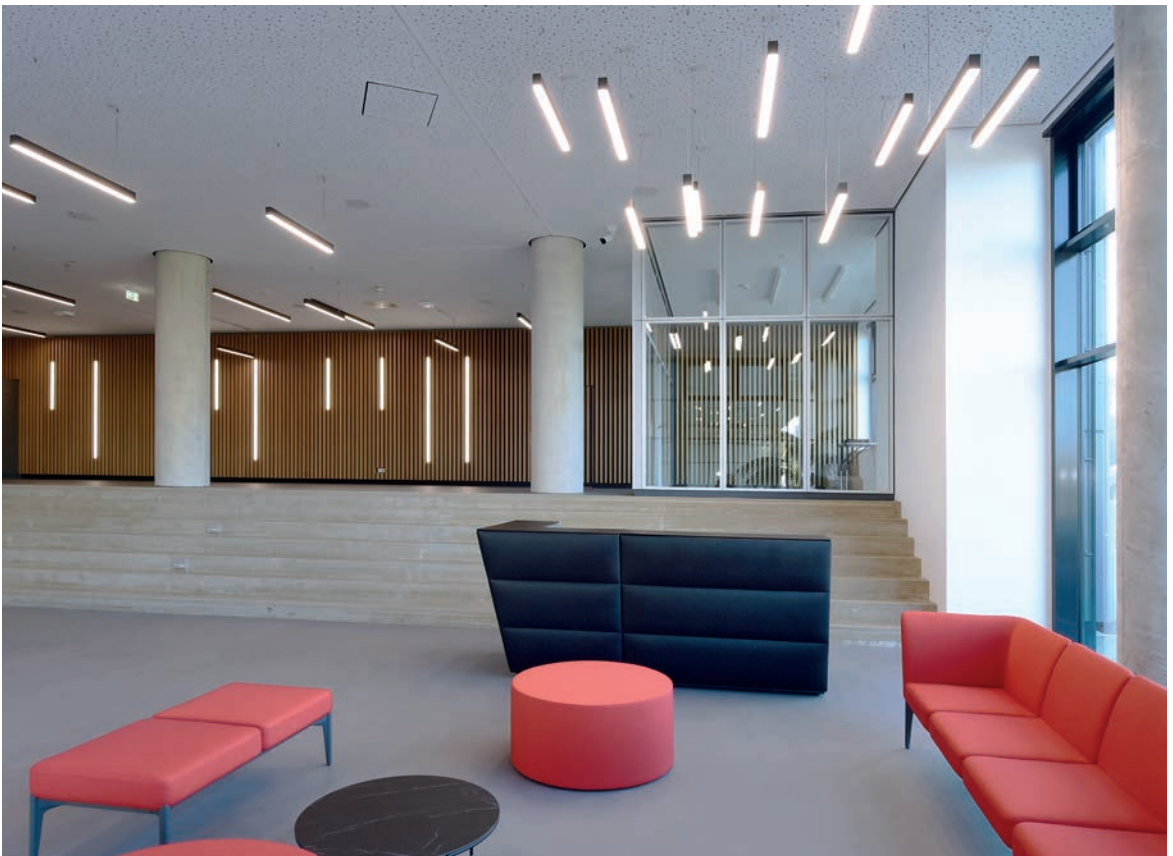



ALUMINIUM PROFILES

- 548 linear light in 5 steps
- 550 aluminium profiles | overview
- 553 assembly for profiles and stripes
- 554 homogeneous light image
- 558 U-profiles | flat + high | built-in/built-on
- 570 T-profiles | flat + high | built-in
- 582 H- und groove-profiles
- 592 step/plinth/angle/corner-profiles | built-in/built-on
- 618 dry construction profiles
- 628 tile profiles
- 644 profiles for outdoor use | walkable/trafficable

LINEAR LIGHT IN 5 STEPS

STEP BY STEP TO BECOMING A LINEAR LIGHT PROFESSIONAL!

It has never been quicker and easier to put together an individually and perfectly coordinated linear light in max. 5 steps. Test how quickly and easily you can put your personal project into practice.

1

CHOOSE YOUR PROFILE

Whether for indoor or outdoor use, for wide or narrow LED stripes, whether the profile is to be should be low or high. Matching to this you can choose between different shapes and light transmittance of the covers.

2

CHOOSE THE RIGHT LED STRIPE

You can choose between strips for indoor or outdoor use, with one or more light colours, high-power strips for basic lighting or fewer lumens for ambient lighting. Various cut sizes and LED spacing also perfectly round off our range here.



3

SELECT THE REQUIRED POWER SUPPLY

In addition to the various protection classes for the respective place of use and voltages, you can choose from different designs and power classes. Our range is complemented by power supplies that can be dimmed directly or controlled via Dali, KNX or 1-10V.

4

DO YOU NEED A CONTROLLER TO STEER?

In this category, you can select the appropriate control controller or LED dimmer according to requirements and customer wishes. Whether control via radio, smartphone, DMX, Dali, etc. – almost no [control] wishes remain unfulfilled!



5

ACCESSORIES, MOUNTING MATERIAL & CO

In the last step, you will find everything that makes installation easier, faster and more comfortable and gives the linear desired light a perfect finish.



U-profiles
flat
from page 558



U-profiles
high
from page 558



T-profiles
flat
from page 570



T-profiles
high
from page 570

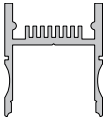

H-Profile
high
page 582



groove-profile
U-profile
page 584

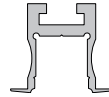

groove-profile
T-profile
page 586



groove-profile
U-profile
page 588

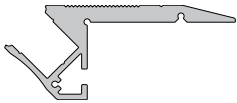

step-profile
built-on
page 592

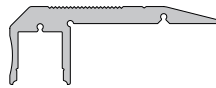

step-profile
built-on
page 594

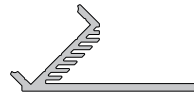

angle-profile
angle 45°
page 596

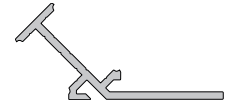

angle-profile
angle 135°
page 598



built-on-Profile
built-on | substructure
page 602

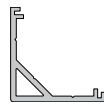

corner-profile
built-on
page 604



corner-profile
built-on
from page 606



socket-profile
built-on
page 600



corner-profile
built-on | built-in
page 608

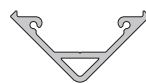

corner-profiles
built-on
from page 610

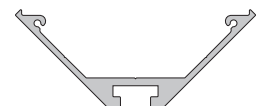

corner-profile
built-on
page 612

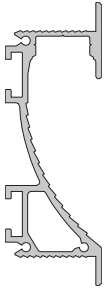

dry construction profile
wall cove
page 618

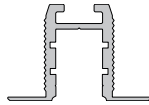

dry construction profile
wall, ceiling
page 620

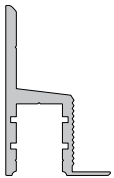

dry construction profile
ceiling cove
page 622

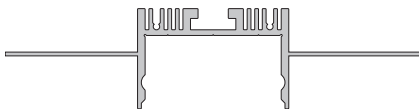

dry construction profile
wall, ceiling
page 624

aluminium profiles



tile profiles
built-in | closing
from page 628

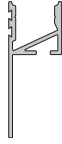

tile profile
closing
page 632

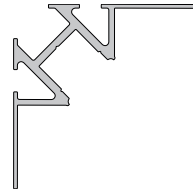

tile profiles
inside corner
from page 634

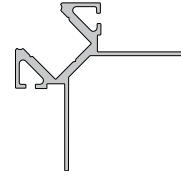

tile profiles
outside corner
from page 636



profile for outdoor
built-in | built-on
page 644



profile for outdoor
built-in
page 646

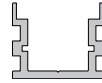

profile for outdoor
built-in | built-on
page 648

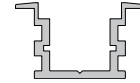

profile for outdoor
built-in
page 650

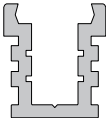

profiles for outdoor
built-in | passable
page 652



ASSEMBLY FOR PROFILES & STRIPES

We provide our products individually made to measure on request.
You will receive the prices on request.



989100 – service package I – profile cut

profile is shortened to desired length, tolerance ± 1 mm | sawing loss 4 mm

989105 – drill hole end cap / profile

hole for cable outlet in end cap or profile



989200 – service package II – cover cut

cover is shortened to desired length, tolerance ± 1 mm | sawing loss 4 mm



989300 – service package III – stripe cut

LED stripe is adapted to desired length, taking into account segment and maximum total length, including soldering of a cable lead of the desired length and open, tinned wire ends

989305 – cable – connecting cable / cores 1 channel

989310 – cable – connecting cable / cores 2 channel

989315 – cable – connecting cable / cores 3 + 4 channel

989320 – cable – mini cable / cores 1 - 4 channel

989325 – cable – connecting cable / cores 5 channel

989301 – 2nd connecting cable

attachment of a 2nd connecting cable / cores for further connection with open tinned wire ends

989302 – connecting cable

attaching / soldering a fixed connection line / cores between 2 stripe pieces

[max. 1m connection line / cores incl., a longer connection will be charged by the metre]

original length and max. total length of the strip to be operated may not be exceeded by sections be exceeded

989350 – IP surcharge – sealing stripe

sealing a shortened IP stripe / gluing an end cap



989400 – service package IV – complete assembly

bringing together and assembling all components into a finished luminaire
incl. function test and cable flag

[for desired length, please add 2cm to the cut length of the LED stripe segment
for connection space, length tolerance ± 2 mm]



HOMOGENEOUS LIGHT IMAGE

How to achieve a homogeneous light image

In combination with a milky 40% cover and a matching LED stripe, a homogeneous light image can be created. The distance [pixel pitch] between the LEDs and the cover is decisive.

The rule of thumb here is:

The distance between the LEDs should be smaller than the distance between the LEDs and the cover.

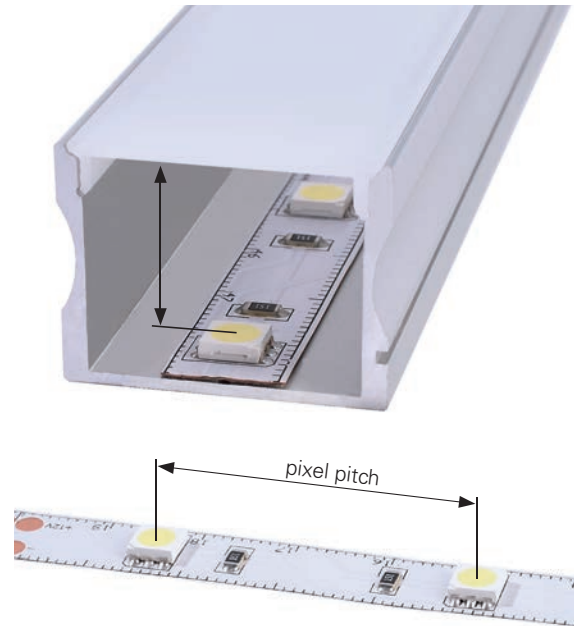

PROFILE DESCRIPTION

mounting type: A = built-on
E = built-in

Width of the series [10 profile] / of the matching LED stripe

AU - 01 - 10

basic form

series

TRANSLUCENCY / LIGHT TRANSMISSION

95% clear

75% mat

40% milky

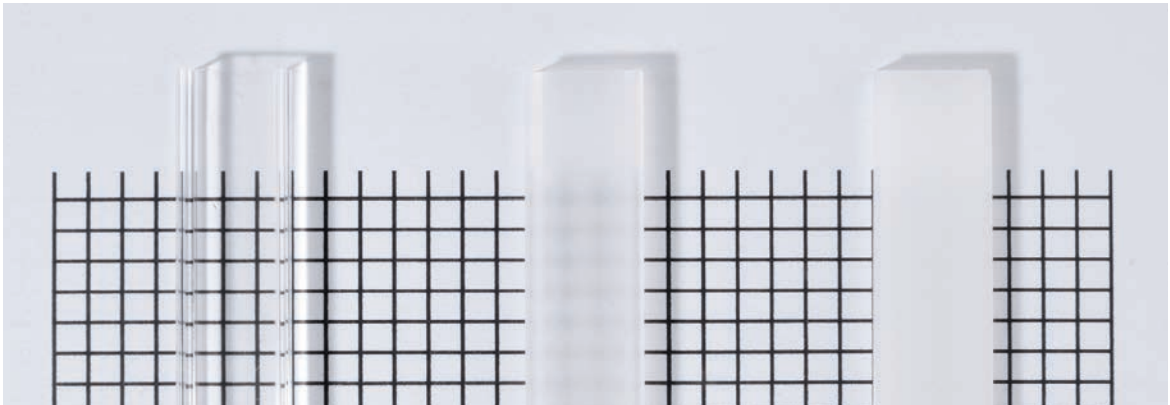
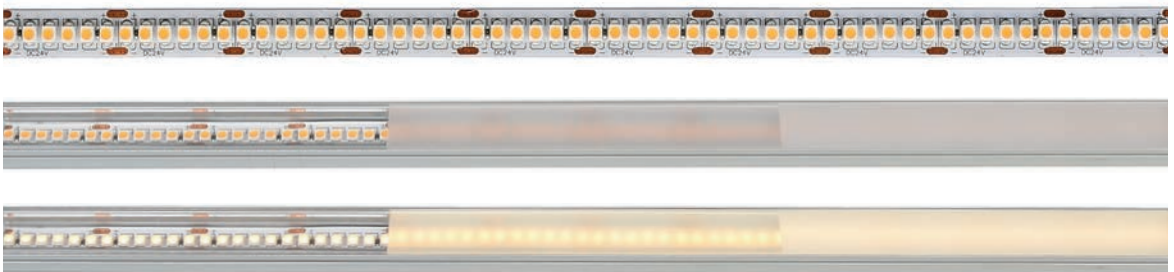

Illustration of various LED stripes with different pixel pitches in combination with three different light transmittances in the covers. This small selection clearly illustrates the optical differences of some LED stripes in combination with different covers.

120 LED/m
cutting option 50 mm / 6 LED



240 LED/m
cutting option 25 mm / 6 LED



700LED/m
cutting option 10 mm / 7 LED

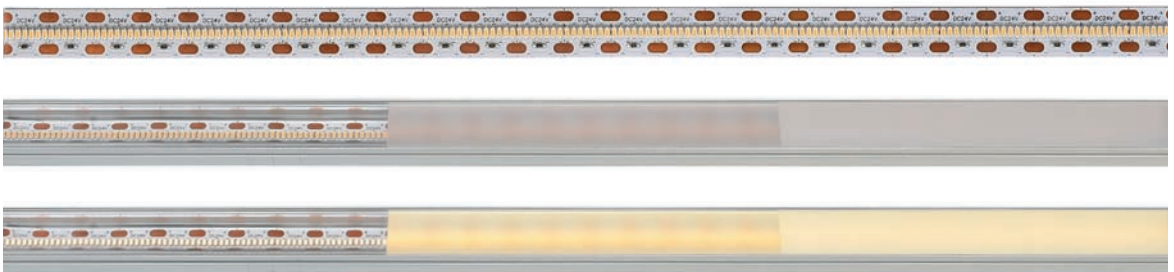

COB 480 LED/m
cutting option 50 mm / 24 LED





With the kind support of BEST Bellemann Elektro Service Team GmbH, Rauenberg-Malschenberg



U- and T-profiles

The profiles of these series are available in various designs. Thanks to their universal profile shape, they can be used flexibly in almost all areas. Thanks to their profile construction, they are ideally suited for the cover cut edges.

AU-01-05

flat U-profile | 5 mm
for LED stripes up to 5,7 mm width

item	colour	dimensions L	price
970080	aluminium anodized	1m	7,95 €
970081	aluminium anodized	2m	17,95 €
970083	black	2m	15,95 €
970085	white	2m	15,95 €

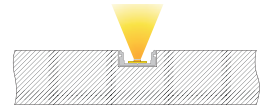
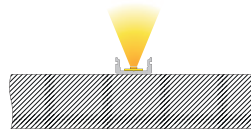
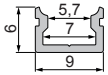
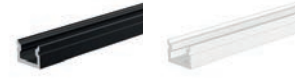

AU-02-05

high U-profile | 5 mm
for LED stripes up to 5,7 mm width

item	colour	dimensions L	price
970180	aluminium anodized	1m	9,95 €
970181	aluminium anodized	2m	18,95 €
970183	black	2m	18,95 €
970185	white	2m	18,95 €

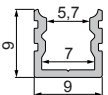
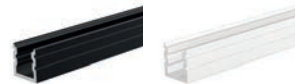

covers | PMMA [polymethylmethacrylat]
for 5 mm profiles

clear mat milky



1m	983550	983554	5,95 €
2m	983551	983555	11,95 €
3m		983556	18,95€



1m		984054	5,95 €
2m		984055	11,95 €



1m		984554	5,95 €
2m		984555	11,95 €

end caps set | 2 pieces **4,95 €**
for 5 mm profiles

- white
- grey
- black



978660
978661
978662



978670
978671
978672



979160
979161
979162



979170
979171
979172



979660
979661
979662



979670
979671
979672



930345 3M double-sided tape | 50 m x 8 mm

27,95 €

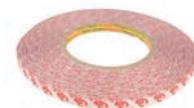

AU-01-08

flat U-profile | 8 mm
for LED stripes up to 9,3 mm width

item	colour	dimensions L	price
970000	aluminium anodized	1m	11,95 €
970001	aluminium anodized	2m	23,95 €
970008	aluminium anodized	3m	35,95 €
970003	black	2m	23,95 €
970005	white	2m	23,95 €
970007	aluminium brushed	2m	23,95 €

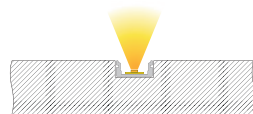
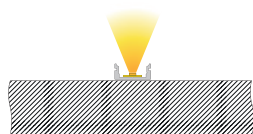
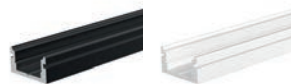
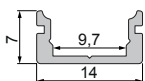

AU-02-08

high U-profile | 8 mm
for LED stripes up to 9,3 mm width

item	colour	dimensions L	price
970101	aluminium anodized	2m	28,95 €
970108	aluminium anodized	3m	42,95 €
970103	black	2m	28,95 €
970105	white	2m	28,95 €

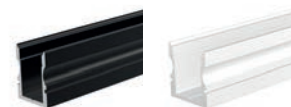
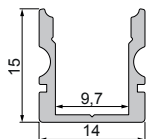

covers | PMMA [polymethylmethacrylat]
for 8 mm profiles

	clear	mat	milky	
				
1m	983000	983002	983004	7,95 €
2m	983001	983003	983005	17,95 €
3m	983006	983007	983008	25,95 €

				
1m	983500	983502	983504	7,95 €
2m	983501	983503	983505	17,95 €
3m			983506	25,95 €

				
1m		984002	984004	7,95 €
2m		984003	984005	17,95 €

				
1m		984502	984504	7,95 €
2m		984503	984505	17,95 €

end caps set | 2 pieces **4,95 €**
for 8 mm profiles

			
	white	grey	black
	978000	978001	978002

			
	white	grey	black
	978500	978501	978502

			
	white	grey	black
	979080	979081	979082

			
	white	grey	black
	979580	979581	979582



978040

978041

978042



978540

978541

978542

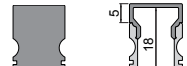

979100

979101

979102



979600

979601

979602

987002 fixation clamp 08 | set consisting of 2 pieces **3,95 €**



987080 universal mounting clip brackets [pivotable] set, 2 pieces | matching fixation clamp must be ordered separately **23,95 €**



930347 3M double-sided tape | 50 m x 12 mm **31,95 €**

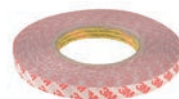

AU-01-10

flat U-profile | 10 mm
for LED stripes up to 11,3 mm width

item	colour	dimensions L	price
970020	aluminium anodized	1m	11,95 €
970021	aluminium anodized	2m	23,95 €
970028	aluminium anodized	3m	35,95 €
970029	aluminium anodized	4m	49,95 €
970023	black	2m	23,95 €
970025	white	2m	23,95 €
970027	aluminium brushed	2m	23,95 €

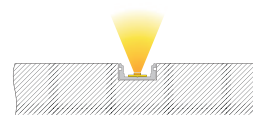
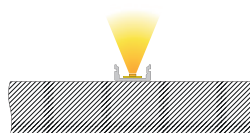
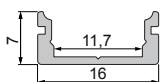



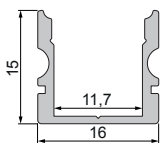
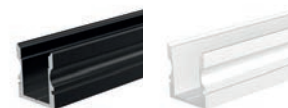

AU-02-10

high U-profile | 10 mm
for LED stripes up to 11,3 mm width



































item	colour	dimensions L	price
970120	aluminium anodized	1m	14,95 €
970121	aluminium anodized	2m	28,95 €
970128	aluminium anodized	3m	44,95 €
970129	aluminium elovxiert	4m	59,95 €
970123	black	2m	28,95 €
970125	white	2m	28,95 €



covers | PMMA [polymethylmethacrylat]
for 10 mm profiles

	clear	mat	milky	
				
1m	983010	983012	983014	7,95 €
2m	983011	983013	983015	17,95 €
3m	983016	983017	983018	25,95 €
4m	983060	983061	983062	33,95 €
				
1m	983510	983512	983514	7,95 €
2m	983511	983513	983515	17,95 €
3m	983516	983517	983518	25,95 €
4m	983560	983561	983562	33,95 €
				
1m		984012	984014	7,95 €
2m		984013	984015	17,95 €
3m		984017	984018	25,95 €
4m		984010	984011	33,95 €
				
1m		984512	984514	7,95 €
2m		984513	984515	17,95 €
3m		984517	984518	25,95 €
4m		984510	984511	33,95 €
				
1m	985010			7,95 €
2m	985011			17,95 €
3m	985016			25,95 €

end caps set | 2 pieces **4,95 €**
for 10 mm profiles

	white	grey	black				
							
	978010	978011	978012	978010	978011	978012	978050
							
	978510	978511	978512	978510	978511	978512	978550
							
	979000	979001	979002	979000	979001	979002	979020
							
	979500	979501	979502	979500	979501	979502	979520
							
	980000	980001	980002	980000	980001	980002	980010

987004 fixation clamp 10 | set consisting of 2 pieces **3,95 €**



987080 universal mounting clip brackets [pivotable] set, 2 pieces | matching fixation clamp must be ordered separately **23,95 €**



930348 3M double-sided tape | 50 m x 15 mm **38,95 €**



AU-01-12

flat U-profile | 12 mm
for LED stripes up to 13,3 mm width

item	colour	dimensions L	price
970040	aluminium anodized	1m	14,95 €
970041	aluminium anodized	2m	28,95 €
970048	aluminium anodized	3m	42,95 €
970043	black	2m	28,95 €
970045	white	2m	28,95 €
970047	aluminium brushed	2m	28,95 €

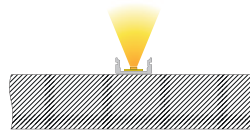
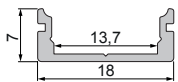



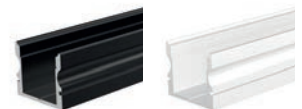
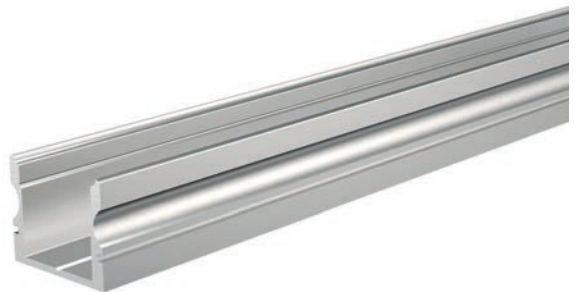
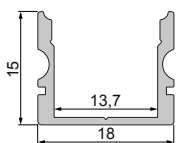

AU-02-12

high U-profile | 12 mm
for LED stripes up to 13,3 mm width

























item	colour	dimensions L	price
970140	aluminium anodized	1m	15,95 €
970141	aluminium anodized	2m	31,95 €
970148	aluminium anodized	3m	44,95 €
970143	black	2m	31,95 €
970145	white	2m	31,95 €
970147	aluminium brushed	2m	31,95 €



covers | PMMA [polymethylmethacrylat]
for 12 mm profiles

	clear	mat	milky	
				
1m	983020	983022	983024	7,95 €
2m	983021	983023	983025	17,95 €
3m	983028	983027	983026	25,95 €
				
1m	983520	983522	983524	7,95 €
2m	983521	983523	983525	17,95 €
3m	983527		983526	25,95 €
				
1m		984022	984024	7,95 €
2m		984023	984025	17,95 €
3m			984026	25,95 €
				
1m		984522	984524	7,95 €
2m		984523	984525	17,95 €
3m			984526	25,95 €

end caps set | 2 pieces **4,95 €**
for 12 mm profiles

		white	978020		grey	978021		black	978022
									
									
									
									
									
									
									

987006 fixation clamp 12 | set consisting of 2 pieces **3,95 €**



987080 universal mounting clip brackets [pivotable] set, 2 pieces | matching fixation clamp must be ordered separately **23,95 €**



930348 3M double-sided tape | 50 m x 15 mm **38,95 €**

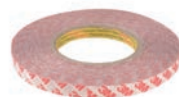

AU-01-15

flat U-profile | 15 mm
for LED stripes up to 16,3 mm width

item	colour	dimensions L	price
970060	aluminium anodized	1m	14,95 €
970061	aluminium anodized	2m	28,95 €
970068	aluminium anodized	3m	42,95 €
970063	black	2m	28,95 €
970065	white	2m	28,95 €

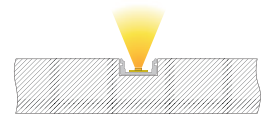
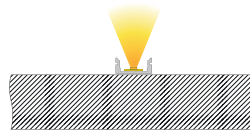
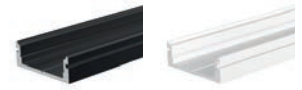
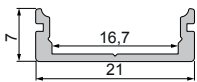

AU-02-15

high U-profile | 15 mm
for LED stripes up to 16,3 mm width

item	colour	dimensions L	price
970160	aluminium anodized	1m	15,95 €
970161	aluminium anodized	2m	31,95 €
970168	aluminium anodized	3m	44,95 €
970163	black	2m	31,95 €
970165	white	2m	31,95 €

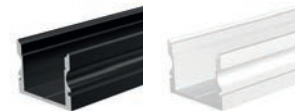
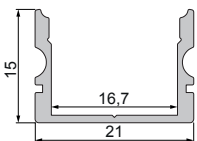

covers | PMMA [polymethylmethacrylat]
for 15 mm profiles

	clear	mat	milky	
				
1m	983030	983032	983034	9,95 €
2m	983031	983033	983035	19,95 €
3m	983038	983037	983036	28,95 €

				
1m	983530	983532	983534	9,95 €
2m	983531	983533	983535	19,95 €
3m		983539	983536	28,95 €

				
1m		984032	984034	9,95 €
2m		984033	984035	19,95 €
3m			984036	28,95 €

				
1m		984532	984534	9,95 €
2m		984533	984535	19,95 €

end caps set | 2 pieces **4,95 €**
for 15 mm profiles

-  white
-  grey
-  black

			
978030	978031	978070	978071
978032	978072		

-  white
-  grey
-  black

			
978530	978531	978570	978571
978532	978572		

-  white
-  grey
-  black

			
979090	979091	979110	979111
979092	979112		

-  white
-  grey
-  black

			
979590	979591	979610	979611
979592	979612		

987008 fixation clamp 15 | set consisting of 2 pieces **3,95 €**



987080 universal mounting clip brackets [pivotable] set, 2 pieces | matching fixation clamp must be ordered separately **23,95 €**



930349 3M double-sided tape | 50 m x 20 mm **48,95 €**

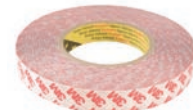

AU-02-20

high U-profile | 20 mm

for LED stripes up to 21,3 mm width

item	colour	dimensions L	price
970201	aluminium anodized	2m	37,95 €
970202	aluminium anodized	3m	59,95 €

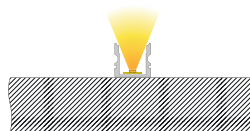
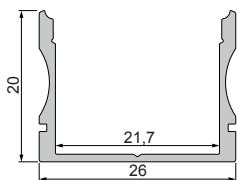

With the kind support of Friese Elektrotechnik, Ettenheim

covers | PMMA [polymethylmethacrylat]
for 20 mm profiles

clear mat milky



1m **983040** **983044** **11,50 €**

2m **983041** **983045** **21,95 €**

3m **983046** **983046** **32,95 €**



1m **984044** **11,50 €**

2m **984045** **21,95 €**



1m **984544** **11,50 €**

2m **984545** **21,95 €**

end caps set | 2 pieces **4,95 €**
for 20 mm profiles

■ grey

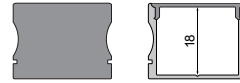

978161

■ grey

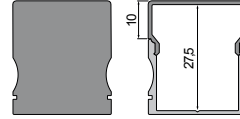

978351

■ grey

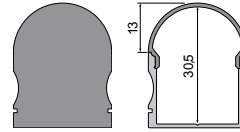

978361

987010 fixation clamp 20 | set consisting of 2 pieces

3,95 €

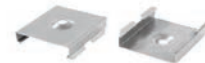

987080 universal mounting clip brackets [pivotable]
set, 2 pieces | matching fixation clamp
must be ordered separately

23,95 €



930350 3M double-sided tape | 50 m x 25 mm

56,95 €

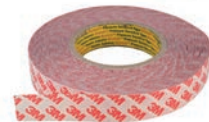

ET-01-05

flat built-in-T-profile | 5 mm
for LED stripes up to 5,7 mm width

item	colour	dimensions L	price
975081	aluminium anodized	2m	17,95 €
975083	black	2m	17,95 €
975085	white	2m	17,95 €

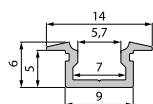

ET-02-05

high built-in-T-profile | 5 mm
for LED stripes up to 5,7 mm width

item	colour	dimensions L	price
975181	aluminium anodized	2m	19,95 €
975183	black	2m	19,95 €
975185	white	2m	19,95 €

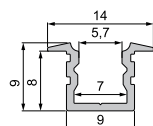
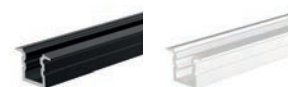

covers | PMMA [polymethylmethacrylat]
for 5 mm profiles

clear mat milky

				
1m	983550	983554	5,95 €	
2m	983551	983555	11,95 €	
3m		983556	18,95€	

				
1m		984054	5,95 €	
2m		984055	11,95 €	

				
1m		984554	5,95 €	
2m		984555	11,95 €	

end caps set | 2 pieces **4,95 €**
for 5 mm profiles

-  white
-  grey
-  black

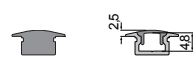

- 978680**
- 978681**
- 978682**

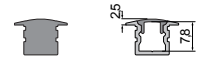

- 978690**
- 978691**
- 978692**

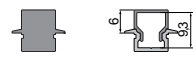

- 979180**
- 979181**
- 979182**



- 979190**
- 979191**
- 979192**

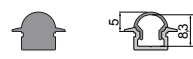

- 979680**
- 979681**
- 979682**

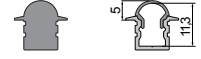

- 979690**
- 979691**
- 979692**

930345 3M double-sided tape | 50 m x 8 mm

27,95 €

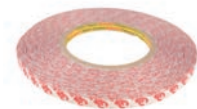

ET-01-08

flat built-in-T-profile | 8 mm
for LED stripes up to 9,3 mm width

item	colour	dimensions L	price
975001	aluminium anodized	2m	26,95 €
975008	aluminium anodized	3m	38,95 €
975003	black	2m	26,95 €
975005	white	2m	26,95 €

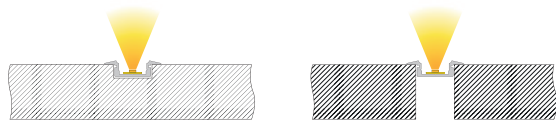
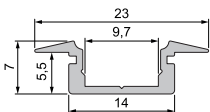
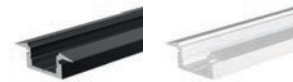

ET-02-08

high built-in-T-profile | 8 mm
for LED stripes up to 9,3 mm width

item	colour	dimensions L	price
975101	aluminium anodized	2m	31,95 €
975108	aluminium anodized	3m	44,95 €
975103	black	2m	31,95 €
975105	white	2m	31,95 €

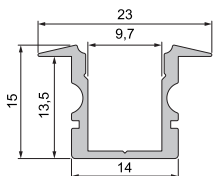
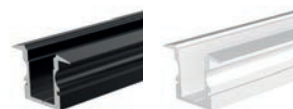

covers | PMMA [polymethylmethacrylat]
for 8 mm profiles

	clear	mat	milky	
				
1m	983000	983002	983004	7,95 €
2m	983001	983003	983005	17,95 €
3m	983006	983007	983008	25,95 €

				
1m	983500	983502	983504	7,95 €
2m	983501	983503	983505	17,95 €
3m			983506	25,95 €

				
1m		984002	984004	7,95 €
2m		984003	984005	17,95 €

				
1m		984502	984504	7,95 €
2m		984503	984505	17,95 €

end caps set | 2 pieces **4,95 €**
for 8 mm profiles

-  white
-  grey
-  black

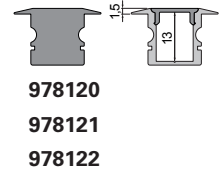
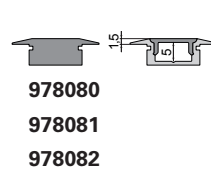

-  white
-  grey
-  black

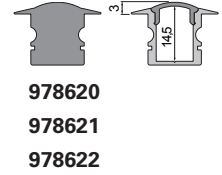
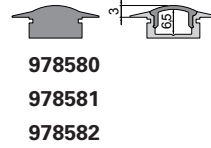

-  white
-  grey
-  black

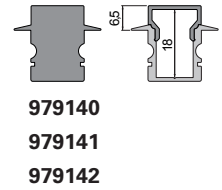
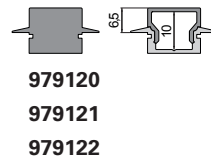

-  white
-  grey
-  black

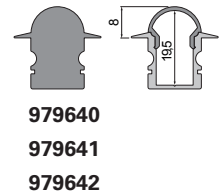
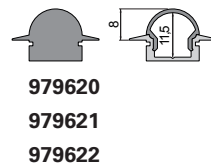

987002 fixation clamp 08 | set consisting of 2 pieces **3,95 €**



987080 universal mounting clip brackets [pivotable] set, 2 pieces | matching fixation clamp must be ordered separately **23,95 €**



930347 3M double-sided tape | 50 m x 12 mm **31,95 €**

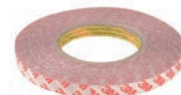

ET-01-10

flat built-in-T-profile | 10 mm
for LED stripes up to 11,3 mm width

item	colour	dimensions L	price
975021	aluminium anodized	2m	26,95 €
975028	aluminium anodized	3m	38,95 €
975029	aluminium anodized	4m	53,95 €
975023	black	2m	26,95 €
975025	white	2m	26,95 €

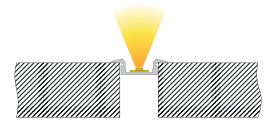
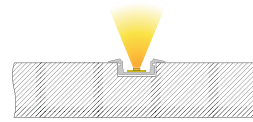
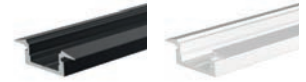
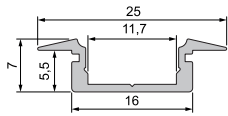



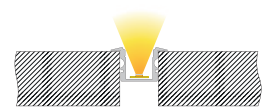
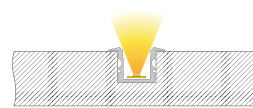
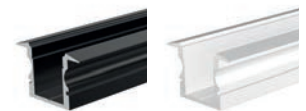
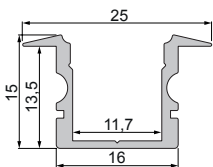

ET-02-10

high built-in-T-profile | 10 mm
for LED stripes up to 11,3 mm width







item	colour	dimensions L	price
975121	aluminium anodized	2m	31,95 €
975128	aluminium anodized	3m	44,95 €
975129	aluminium anodized	4m	64,95 €
975123	black	2m	31,95 €
975125	white	2m	31,95 €



covers | PMMA [polymethylmethacrylat] for 10 mm profiles

	clear	mat	milky	
				
1m	983010	983012	983014	7,95 €
2m	983011	983013	983015	17,95 €
3m	983016	983017	983018	25,95 €
4m	983060	983061	983062	33,95 €
				
1m	983510	983512	983514	7,95 €
2m	983511	983513	983515	17,95 €
3m	983516	983517	983518	25,95 €
4m	983560	983561	983562	33,95 €
				
1m		984012	984014	7,95 €
2m		984013	984015	17,95 €
3m		984017	984018	25,95 €
4m		984010	984011	33,95 €
				
1m		984512	984514	7,95 €
2m		984513	984515	17,95 €
3m		984517	984518	25,95 €
4m		984510	984511	33,95 €
				
1m	985010			7,95 €
2m	985011			17,95 €
3m	985016			25,95 €

end caps set | 2 pieces **4,95 €**
for 10 mm profiles

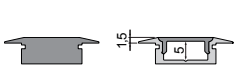
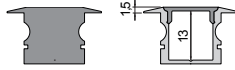
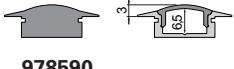
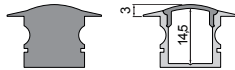
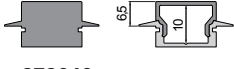
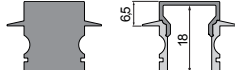
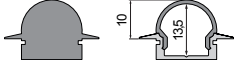
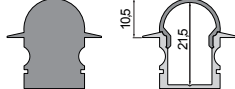
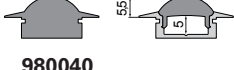
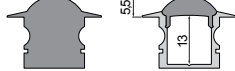
	white	grey	black		white	grey	black	
								
	978090	978091	978092		978130	978131	978132	
	978590	978591	978592		978630	978631	978632	
	979040	979041	979042		979060	979061	979062	
	979540	979541	979542		979560	979561	979562	
	980040	980041	980042		980060	980061	980062	

987004 fixation clamp 10 | set consisting of 2 pieces

3,95 €



987080 universal mounting clip brackets [pivotable] set, 2 pieces | matching fixation clamp must be ordered separately

23,95 €



930348 3M double-sided tape | 50 m x 15 mm

38,95 €

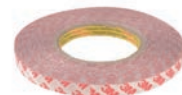

ET-01-12

flat built-in-T-profile | 12 mm
for LED stripes up to 13,3 mm width

item	colour	dimensions L	price
975041	aluminium anodized	2m	31,95 €
975043	black	2m	31,95 €
975045	white	2m	31,95 €

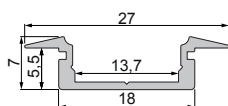



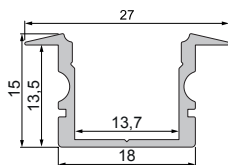
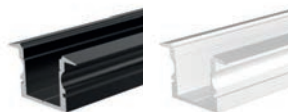

ET-02-12

high built-in-T-profile | 12 mm
for LED stripes up to 13,3 mm width



item	colour	dimensions L	price
975141	aluminium anodized	2m	35,95 €
975148	aluminium anodized	3m	54,95 €
975143	black	2m	35,95 €
975145	white	2m	35,95 €



covers | PMMA [polymethylmethacrylat]
for 12 mm profiles

	clear	mat	milky	
				
1m	983020	983022	983024	7,95 €
2m	983021	983023	983025	17,95 €
3m	983028	983027	983026	25,95 €
				
1m	983520	983522	983524	7,95 €
2m	983521	983523	983525	17,95 €
3m	983527		983526	25,95 €
				
1m		984022	984024	7,95 €
2m		984023	984025	17,95 €
3m			984026	25,95 €
				
1m		984522	984524	7,95 €
2m		984523	984525	17,95 €
3m			984526	25,95 €

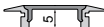
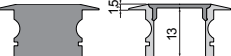
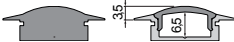
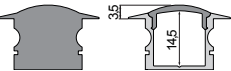
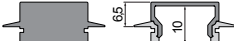
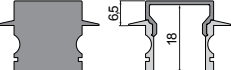
end caps set | 2 pieces **4,95 €**
for 12 mm profiles

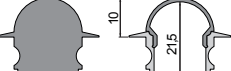
	white	grey	black
			
	978100	978101	978140
			978141
			978142
			
	978600	978601	978640
			978641
			978642
			
	979050	979051	979070
			979071
			979072
			
	979550	979551	979570
			979571
			979572

987006 fixation clamp 12 | set consisting of 2 pieces

3,95 €



987080 universal mounting clip brackets [pivotable]
set, 2 pieces | matching fixation clamp
must be ordered separately

23,95 €



930348 3M double-sided tape | 50 m x 15 mm

38,95 €

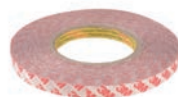

ET-01-15

flat built-in-T-profile | 15 mm
for LED stripes up to 16,3 mm width

item	colour	dimensions L	price
975061	aluminium anodized	2m	31,95 €
975063	black	2m	31,95 €
975065	white	2m	31,95 €

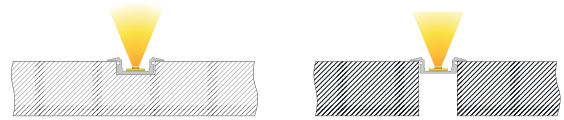
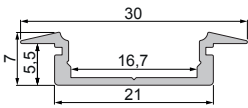
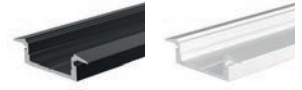
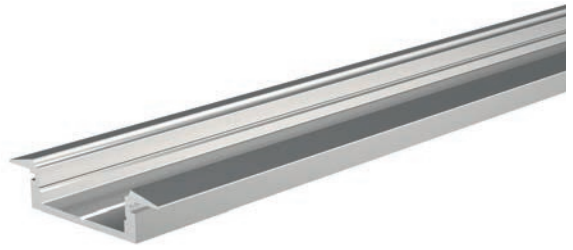



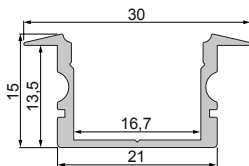
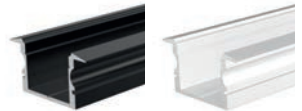

ET-02-15

high built-in-T-profile | 15 mm
for LED stripes up to 16,3 mm width

item	colour	dimensions L	price
975161	aluminium anodized	2m	35,95 €
975168	aluminium anodized	3m	54,95 €
975163	black	2m	35,95 €
975165	white	2m	35,95 €









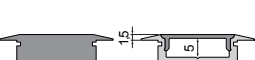

covers | PMMA [polymethylmethacrylat]
for 15 mm profiles

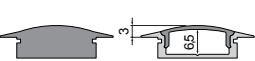
	clear	mat	milky	
				
1m	983030	983032	983034	9,95 €
2m	983031	983033	983035	19,95 €
3m	983038	983037	983036	28,95 €
				
1m	983530	983532	983534	9,95 €
2m	983531	983533	983535	19,95 €
3m		983539	983536	28,95 €
				
1m		984032	984034	9,95 €
2m		984033	984035	19,95 €
3m			984036	28,95 €
				
1m		984532	984534	9,95 €
2m		984533	984535	19,95 €

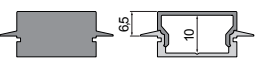
end caps set | 2 pieces 4,95 €
for 15 mm profiles

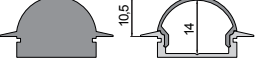
-  white
-  grey
-  black

	978110	978150
	978111	978151
	978112	978152
	978610	978650
	978611	978651
	978612	978652
	979130	979150
	979131	979151
	979132	979152
	979630	979650
	979631	979651
	979632	979652

987008 fixation clamp 15 | set consisting of 2 pieces

3,95 €



987080 universal mounting clip brackets [pivotable]
set, 2 pieces | matching fixation clamp
must be ordered separately

23,95 €



930349 3M double-sided tape | 50 m x 20 mm

48,95 €





With the kind support of BEST Bellemann Elektro Service Team GmbH, Rauenberg-Malschenberg



H- und groove-profiles

Groove and H-profiles are offered with a comprehensive range of mounting accessories and are hard to beat in terms of versatility. The range of accessories includes cable suspensions, tension springs, sliding blocks and much more.

AH-01-20

H-profile with cooling fins and mounting profile | 20 mm for LED stripes up to 21,3 mm width

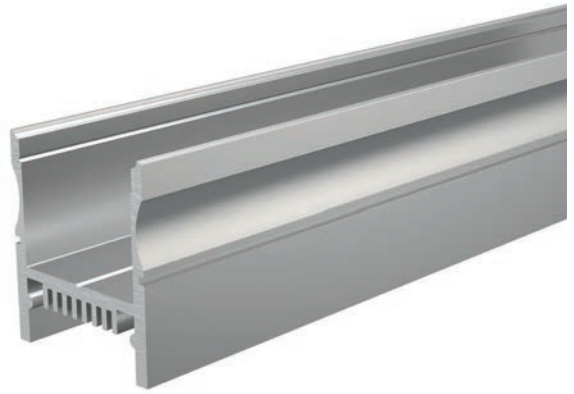

item	colour	dimensions L	price
970261	aluminium anodized	2m	46,95 €
970262	aluminium anodized	3m	74,95 €

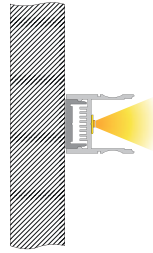
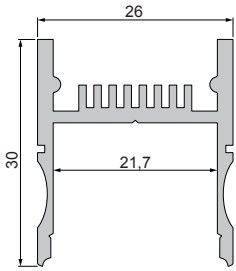



With the kind support of BEST Bellemann Elektro Service Team GmbH, Rauenberg-Malschenberg

covers | PMMA [polymethylmethacrylat]
for 20 mm profiles

clear mat milky

			
1m	983040	983044	11,50 €
2m	983041	983045	21,95 €
3m		983046	32,95 €

			
1m		984044	11,50 €
2m		984045	21,95 €

			
1m		984544	11,50 €
2m		984545	21,95 €

end caps set | 2 pieces **4,95 €**
for 20 mm profiles

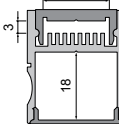
		
grey	978311	

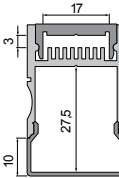
		
grey	979241	

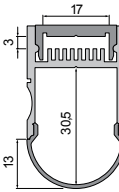
		
grey	979741	

MOUNTING / CARRIER PROFILE FOR H-PROFILE 20 MM

for AH-01-20

970770  1m aluminium natural **11,95 €**

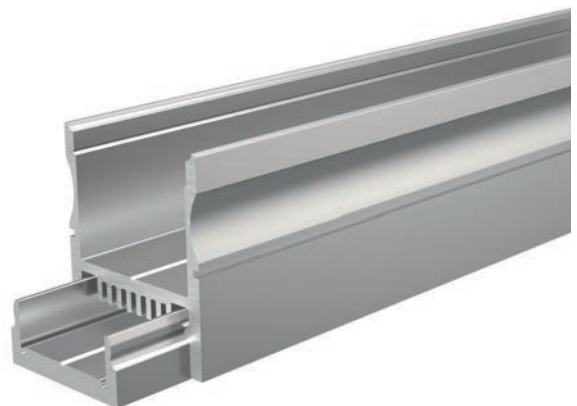
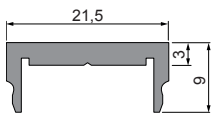

AU-03-12

groove profiles for pendulum | 12 mm | suitable for rope suspension
for LED stripes up to 13,3 mm width

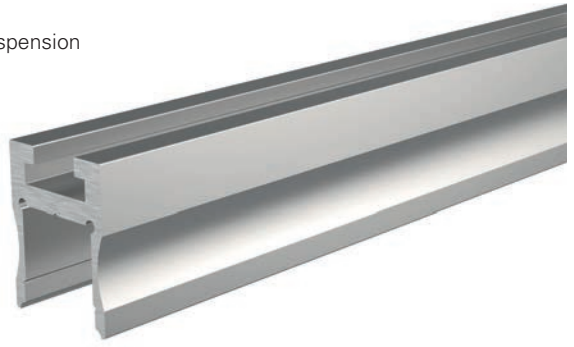

item	colour	dimensions L	price
970231	aluminium anodized	2m	37,95 €

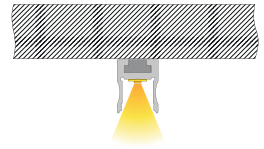
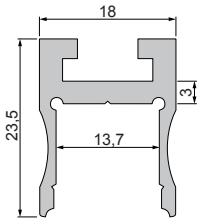



With the kind support of Friese Elektrotechnik, Ettenheim

covers | PMMA [polymethylmethacrylat]
for 12 mm profiles

clear mat milky

				
1m	983020	983022	983024	7,95 €
2m	983021	983023	983025	17,95 €
3m	983028	983027	983026	25,95 €

				
1m	983520	983522	983524	7,95 €
2m	983521	983523	983525	17,95 €
3m	983527		983526	25,95 €

				
1m		984022	984024	7,95 €
2m		984023	984025	17,95 €
3m			984026	25,95 €

				
1m		984522	984524	7,95 €
2m		984523	984525	17,95 €
3m			984526	25,95 €

end caps set | 2 pieces **4,95 €**
for 12 mm profiles

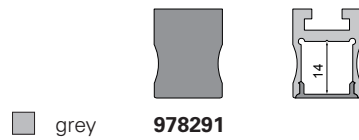

grey **978291**

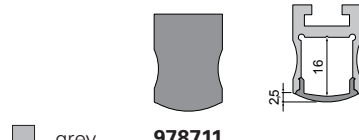

grey **978711**

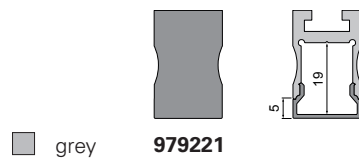

grey **979221**

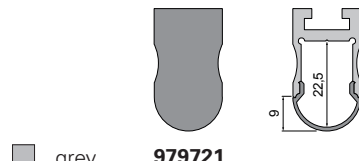

grey **979721**

987060 wire suspension, pivotable, 2m | set | 2 pieces
For the installation of the wire suspension you need, depending on the profile, the universal sliding block 987020.

35,95 €



987020 universal sliding block/straight connector set | 2 pieces

7,95 €



ET-04-12

groove-built-in-T-profile | 12 mm
for LED stripes up to 13,3 mm width



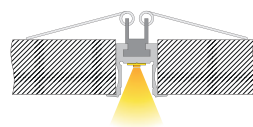
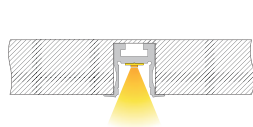
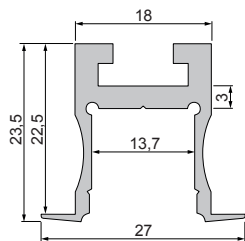

item	colour	dimensions L	price
975231	aluminium anodized	2m	39,95 €





covers | PMMA [polymethylmethacrylat]
for 12 mm profiles

clear mat milky

				
1m	983020	983022	983024	7,95 €
2m	983021	983023	983025	17,95 €
3m	983028	983027	983026	25,95 €

				
1m	983520	983522	983524	7,95 €
2m	983521	983523	983525	17,95 €
3m	983527		983526	25,95 €

				
1m		984022	984024	7,95 €
2m		984023	984025	17,95 €
3m			984026	25,95 €

				
1m		984522	984524	7,95 €
2m		984523	984525	17,95 €
3m			984526	25,95 €

end caps set | 2 pieces **4,95 €**
for 12 mm profiles

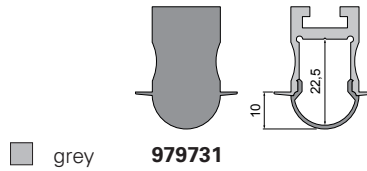
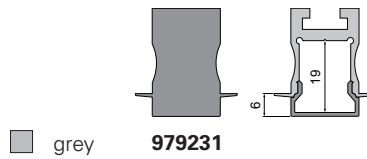
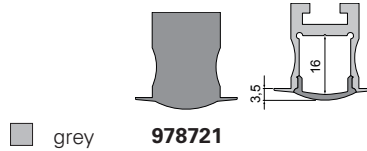

end caps set | 2 pieces | aluminium **21,95 €**

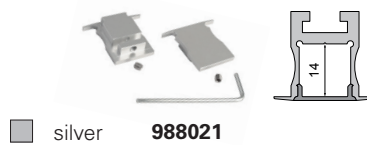

987040 sliding block with springset
set | 2 pieces

7,95 €

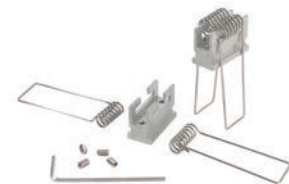

987020 universal sliding block/straight connector
set | 2 pieces

7,95 €



AU-10-12

groove-U-profile | 12 mm
for LED stripes up to 13 mm width



item	colour	dimensions L	price
970280	aluminium anodized	2m	35,95 €
970281	aluminium anodized	3m	54,95 €
970284	white	2m	35,95 €
970285	white	3m	54,95 €

- multifunction
- pendulum
- concealed mounting
- extendable through corner / longitudinal connectors

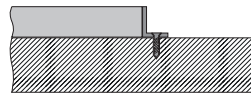
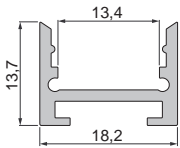
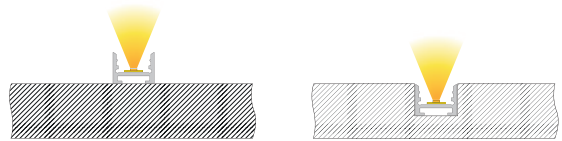

With the kind support of Friese Elektrotechnik, Ettenheim

covers | PMMA [polymethylmethacrylat]
for 12 mm profiles

clear mat milky



2m	983090	23,95 €
3m	983091	35,95 €

end caps set | 2 pieces | aluminium **19,95 €**
for 12 mm profiles

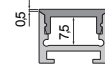

 silver **980020**



 silver **980021**



980020

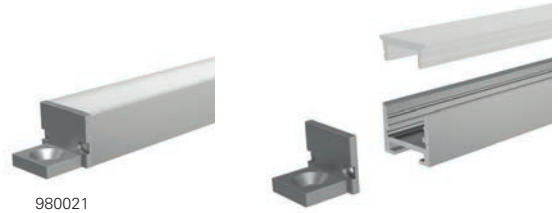

980021

980023 mountings clip | Set | 2 pieces **4,95 €**



987025 sliding block | straight connector **9,95 €**



987026 sliding block | 120° corner connector **9,95 €**



987027 sliding block | 90° corner connector **9,95 €**





With the kind support of Alitherme Waldbronn / Ziegler Technics buero@ziegler-technics.de



step-, socket-, angle-, corner-profiles

The perfect light is not always planned from the very start. With the mounting and corner profiles, you can also integrate linear light at a later stage.

AL-01-10

step-profile | 10 mm
for LED stripes up to 11,3 mm width

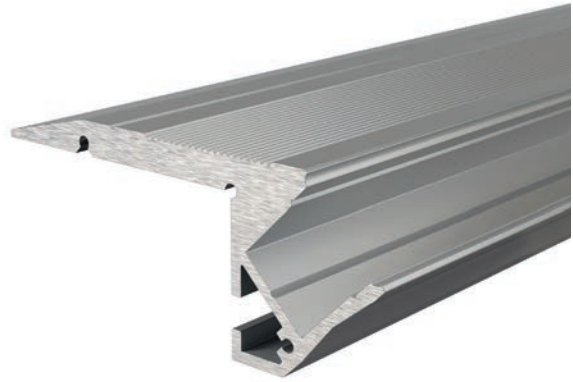

item	colour	dimensions L	price
970503	aluminium anodized	2m	59,95 €
970502	aluminium anodized	3m	94,95 €

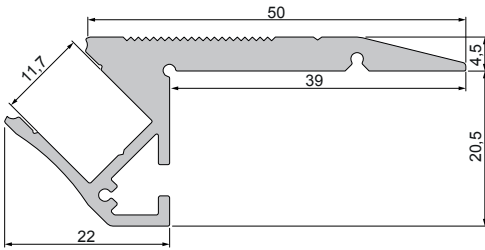

With the kind support of SH-Lichttechnik, Pfullingen und Becks Reutlingen

covers | PMMA [polymethylmethacrylat]
for 10 mm profiles

clear mat milky



1m	983010	983012	983014	7,95 €
2m	983011	983013	983015	17,95 €
3m	983016	983017	983018	25,95 €
4m	983060	983061	983062	33,95 €



walkable | PC [polycarbonate]

1m		983080	11,50 €
2m		983081	21,95 €
3m		983082	32,95 €

end caps set | right + left **4,95 €**
for 10 mm profiles



■ grey

978191

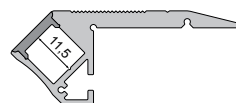
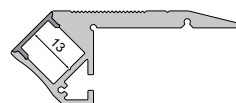

AL-02-10

step-profile | 10 mm

for LED stripes up to 11,3 mm width



item	colour	dimensions L	price
970520	aluminium anodized	1m	30,95 €
970523	aluminium anodized	2m	59,95 €
970522	aluminium anodized	3m	94,95 €

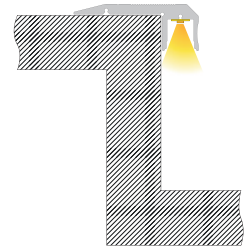
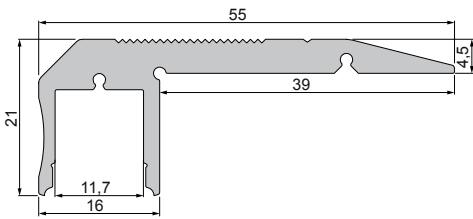

With the kind support of Elektro Grün, Neustadt an der Weinstraße

covers | PMMA [polymethylmethacrylat]
for 10 mm profiles

clear mat milky



1m	983010	983012	983014	7,95 €
2m	983011	983013	983015	17,95 €
3m	983016	983017	983018	25,95 €
4m	983060	983061	983062	33,95 €

end caps set | right + left **4,95 €**
for 10 mm profiles

 grey

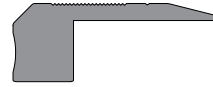

978201

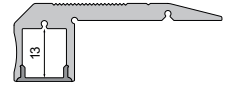

AV-01-20

angle-profile 45° for coving | with cooling fins on one side | 22 mm
for LED stripes up to 22 mm width



item	colour	dimensions L	price
970460	aluminium anodized	2m	35,95 €

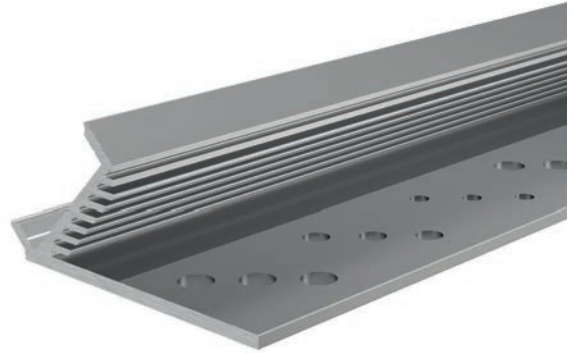
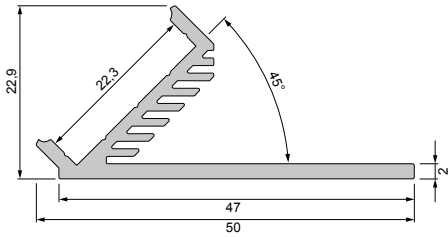

pre-punched drill / screw holes [Ø 3; 4 und 5 mm]
for easier mounting

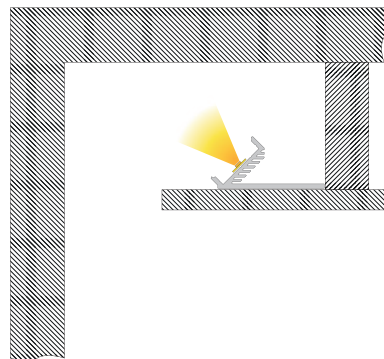
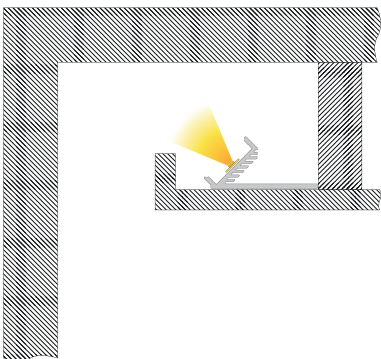
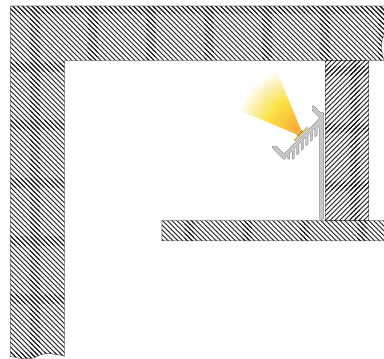
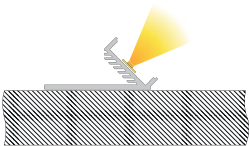

covers | PMMA [polymethylmethacrylat]
for 22 mm profiles

clear mat milky



1m	983040	983044	11,50 €
2m	983041	983045	21,95 €
3m		983046	32,95 €

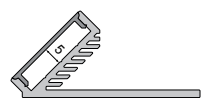

1m		984044	11,50 €
2m		984045	21,95 €

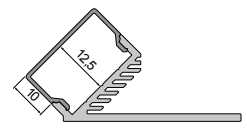

1m		984544	11,50 €
2m		984545	21,95 €

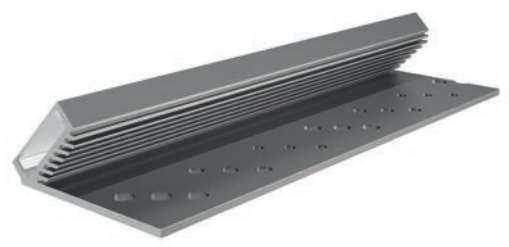
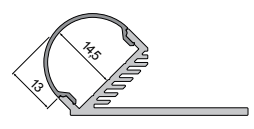

930105 310ml cartridge, white | glue+sealing power

35,95 €



930350 3M double-sided tape | 50 m x 25 mm

56,95 €

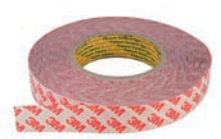

AV-02-20

angle-profile 135° for coving | double-sided | 20 mm
for LED stripes up to 22 / 17 mm width

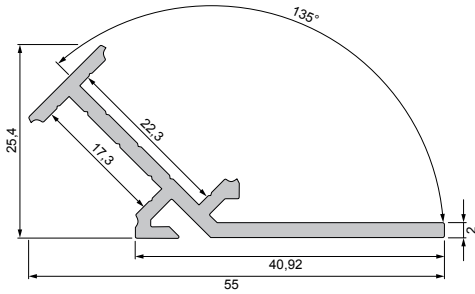

pre-punched drill / screw holes [Ø 3; 4 und 5 mm]
for easier mounting

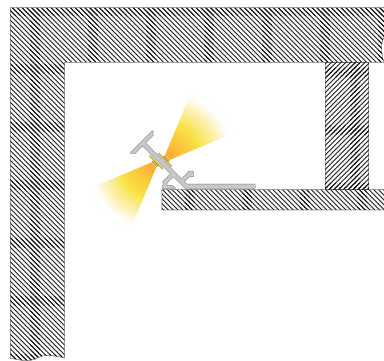
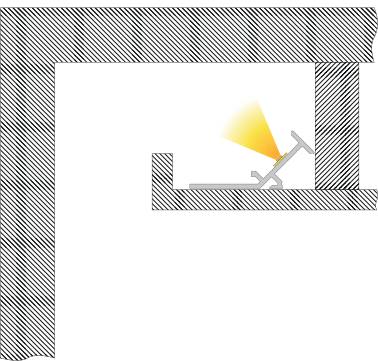
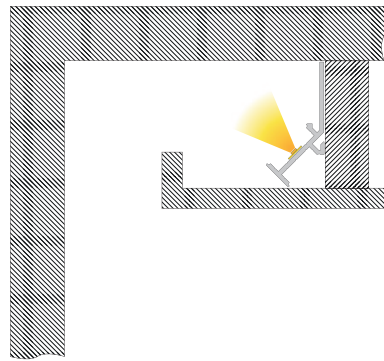
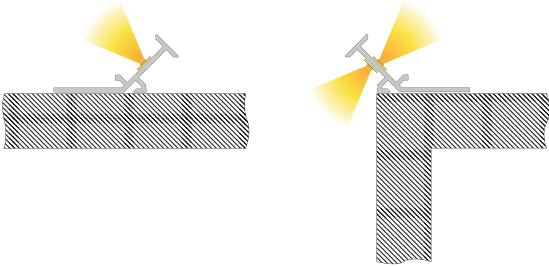

20er covers | PMMA [polymethylmethacrylat]

clear mat milky

			
1m	983040	983044	11,50 €
2m	983041	983045	21,95 €
3m		983046	32,95 €

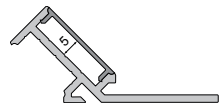

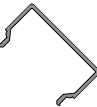
			
1m		984044	11,50 €
2m		984045	21,95 €

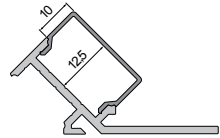

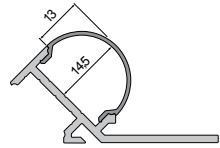

			
1m		984544	11,50 €
2m		984545	21,95 €



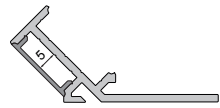

15er covers | PMMA [polymethylmethacrylat]

				
1m	983030	983032	983034	9,95 €
2m	983031	983033	983035	19,95 €
3m	983038	983037	983036	28,95 €

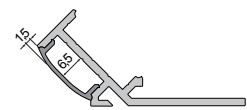

				
1m	983530	983532	983534	9,95 €
2m	983531	983533	983535	19,95 €
3m		983539	983536	28,95 €



				
1m		984032	984034	9,95 €
2m		984033	984035	19,95 €
3m			984036	28,95 €

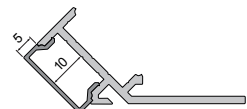

				
1m		984532	984534	9,95 €
2m		984533	984535	19,95 €

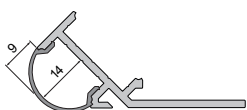

930105 310ml cartridge, white | glue+sealing power

35,95 €



930350 3M double-sided tape | 50 m x 25 mm

56,95 €

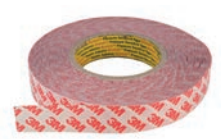

AM-02-10

socket-profile | 10 mm

for LED stripes up to 11,3 mm width

item	colour	dimensions L	price
970602	aluminium anodized	2m	82,95 €
970600	aluminium anodized	3m	124,95 €
970601	black	3m	124,95 €

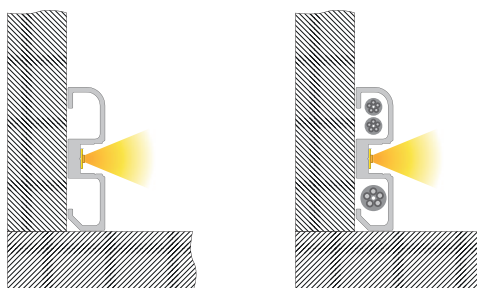
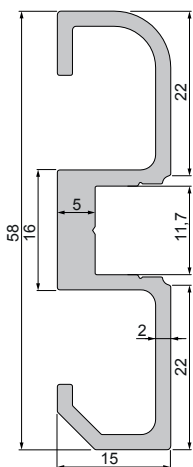

covers | PMMA [polymethylmethacrylat]
for 10 mm profiles

clear mat milky



1m	983010	983012	983014	7,95 €
2m	983011	983013	983015	17,95 €
3m	983016	983017	983018	25,95 €
4m	983060	983061	983062	33,95 €



1m	983510	983512	983514	7,95 €
2m	983511	983513	983515	17,95 €
3m	983516	983517	983518	25,95 €
4m	983560	983561	983562	33,95 €



1m		984012	984014	7,95 €
2m		984013	984015	17,95 €
3m		984017	984018	25,95 €
4m		984010	984011	33,95 €

end caps set | right + left **4,95 €**

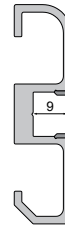

■ grey **978241**
■ black **978242**

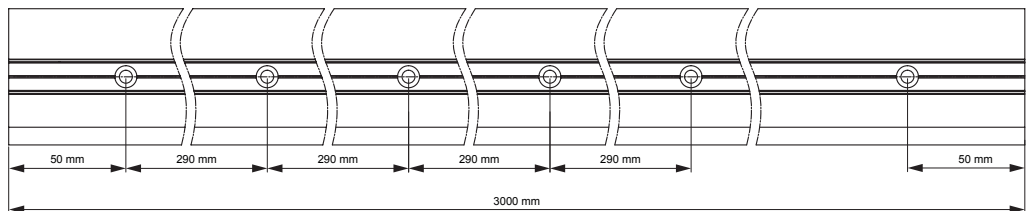
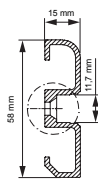
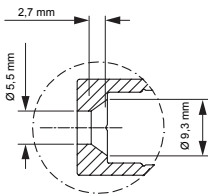

AM-01-10

built-on / substructure-profile | ultraflach, H: 7 mm | 10 mm
for LED stripes up to 11,3 mm width



item	colour	dimensions L	price
970301	aluminium anodized	2m	37,95 €
970308	aluminium anodized	3m	59,95 €
970303	black	2m	37,95 €
970305	white	2m	37,95 €

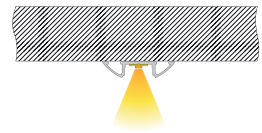
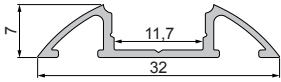

With the kind support of BEST Bellemann Elektro Service Team GmbH, Raunberg-Malschenberg

covers | PC [polycarbonate]
for 10 mm profiles

clear mat milky



1m	983010	983012	983014	7,95 €
2m	983011	983013	983015	17,95 €
3m	983016	983017	983018	25,95 €
4m	983060	983061	983062	33,95 €



1m	983510	983512	983514	7,95 €
2m	983511	983513	983515	17,95 €
3m	983516	983517	983518	25,95 €
4m	983560	983561	983562	33,95 €

end caps set | 2 pieces **4,95 €**
for 10 mm profiles

- white **978700**
- grey **978701**
- black **978702**

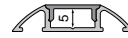

- grey **980541**

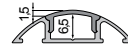

930105 310ml cartridge, white | glue+sealing power **35,95 €**



930348 3M double-sided tape | 50 m x 15 mm **38,95 €**

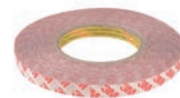

AV-03-12

corner-profile | 12 mm
for LED stripes up to 13,3 mm width



item	colour	dimensions L	price
970433	aluminium anodized	2m	37,95 €
970431	aluminium anodized	2,5m	46,95 €
970434	aluminium anodized	3m	59,95 €
970437	white	2m	37,95 €
970438	white	3m	59,95 €

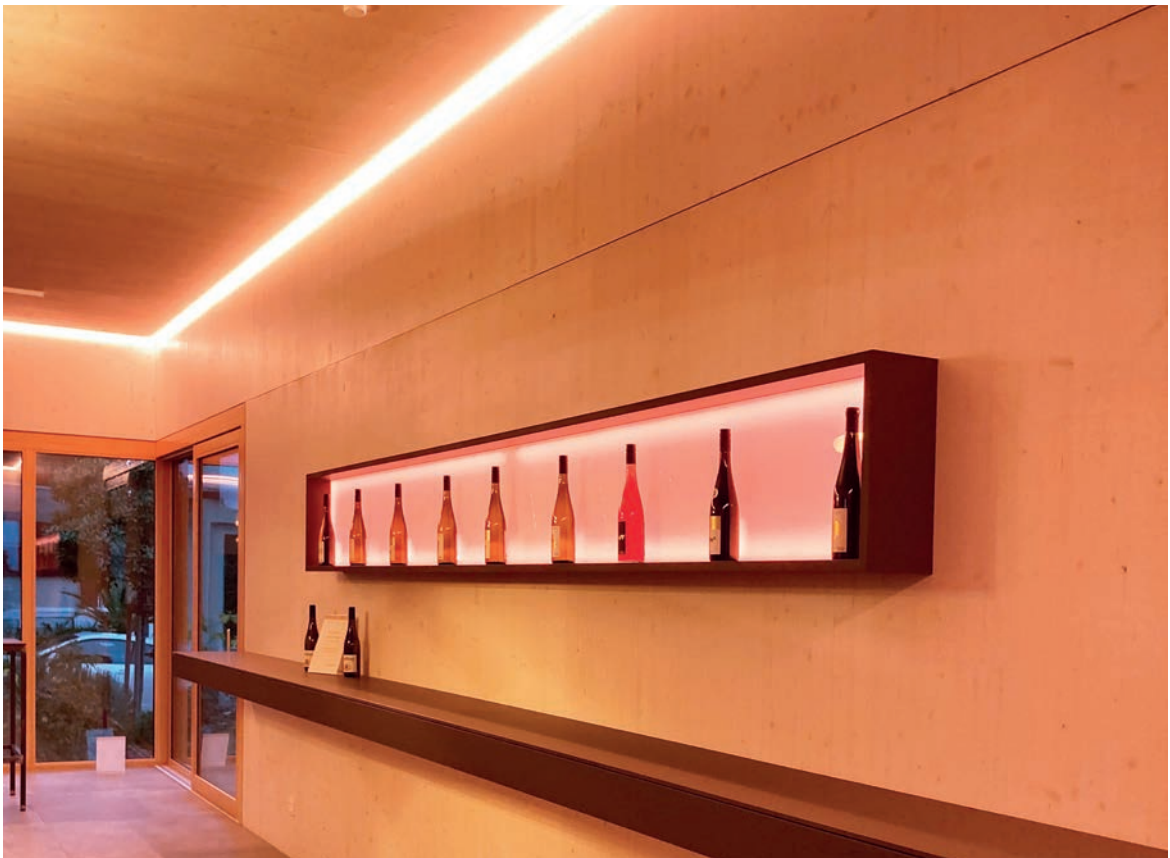
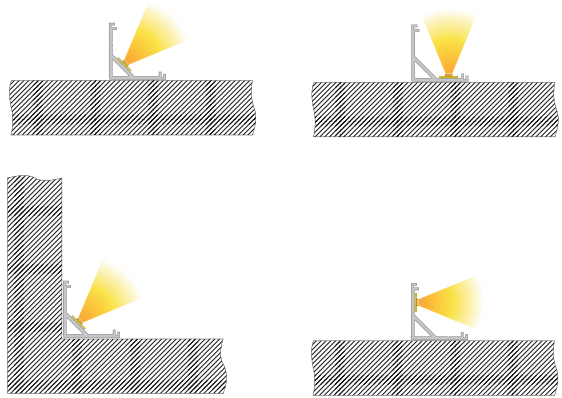
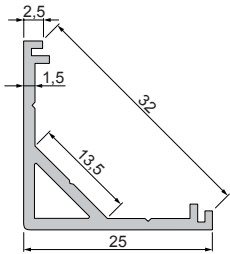

With the kind support of Elektro Grün, Neustadt an der Weinstraße

covers | PC [polycarbonate]
for 12 mm profiles

clear mat milky



2m
3m

984565 **21,95 €**
984568 **32,95 €**

end caps set | 2 pieces **4,95 €**
for 12 mm profiles

 grey

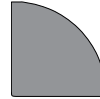

979751

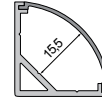

930105 310ml cartridge, white | glue+sealing power

35,95 €



930348 3M double-sided tape | 50 m x 15 mm

38,95 €

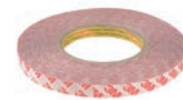

AV-01-10

corner-profile | 10 mm
for LED stripes up to 11,3 mm width



item	colour	dimensions L	price
970401	■ aluminium anodized	2m	35,95 €
970404	■ aluminium anodized	3m	54,95 €
970403	□ white	2m	35,95 €



Foto: Daniel Visser - Architektur fotografie, Karlsruhe

covers | PMMA [polymethylmethacrylat]
for 10 mm profiles

clear mat milky

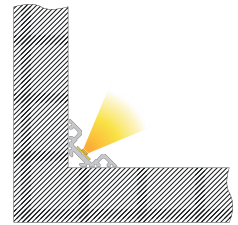
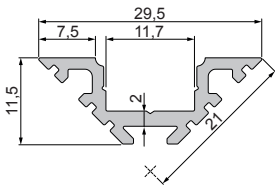

1m	983010	983012	983014	7,95 €
2m	983011	983013	983015	17,95 €
3m	983016	983017	983018	25,95 €
4m	983060	983061	983062	33,95 €



1m	983510	983512	983514	7,95 €
2m	983511	983513	983515	17,95 €
3m	983516	983517	983518	25,95 €
4m	983560	983561	983562	33,95 €



1m		984012	984014	7,95 €
2m		984013	984015	17,95 €
3m		984017	984018	25,95 €
4m		984010	984011	33,95 €





1m		984512	984514	7,95 €
2m		984513	984515	17,95 €
3m		984517	984518	25,95 €
4m		984510	984511	33,95 €



1m	985010			7,95 €
2m	985011			17,95 €
3m	985016			25,95 €

end caps set | 2 pieces **4,95 €**
for 10 mm profiles

 white **978170**
 grey **978171**

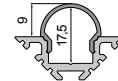
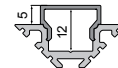
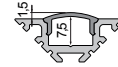
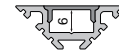

930105 310ml cartridge, white | glue+sealing power **35,95 €**



930348 3M double-sided tape | 50 m x 15 mm **38,95 €**

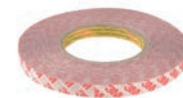

EV-04-12

corner-profile | 12 mm
for LED stripes up to 13,3 mm width

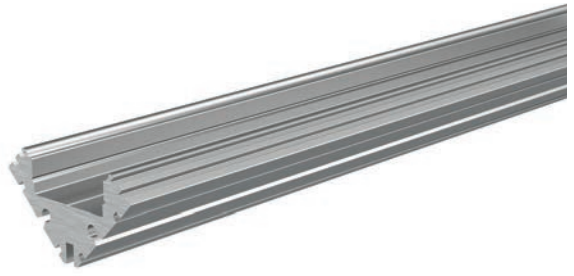

item	colour	dimensions L	price
975411	aluminium anodized	2m	39,95 €
975412	aluminium anodized	3m	61,95 €

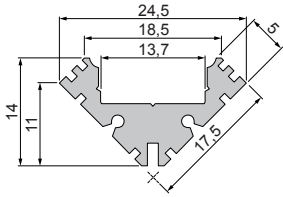

With the kind support of Elektro Grün, Neustadt an der Weinstraße

covers | PMMA [polymethylmethacrylat]
for 12 mm profiles

clear mat milky



1m	983020	983022	983024	7,95 €
2m	983021	983023	983025	17,95 €
3m	983028	983027	983026	25,95 €



1m	983520	983522	983524	7,95 €
2m	983521	983523	983525	17,95 €
3m	983527		983526	25,95 €



1m		984022	984024	7,95 €
2m		984023	984025	17,95 €
3m			984026	25,95 €



1m		984522	984524	7,95 €
2m		984523	984525	17,95 €
3m			984526	25,95 €

end caps set | 2 pieces **4,95 €**
for 12 mm profiles

■ grey

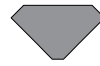

978341

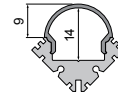
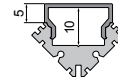
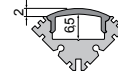
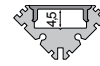

987006 fixation clamp 12 | set consisting of 2 pieces **3,95 €**



987080 universal mounting clip brackets [pivotable]
set, 2 pieces | matching fixation clamp
must be ordered separately **23,95 €**



930105 310ml cartridge, white | glue+sealing power **35,95 €**



AV-05-12

corner-profile | 12 mm
for LED stripes up to 12,5 mm width



item	colour	dimensions L	price
970550	aluminium anodized	2m	39,95 €
970551	aluminium anodized	3m	59,95 €

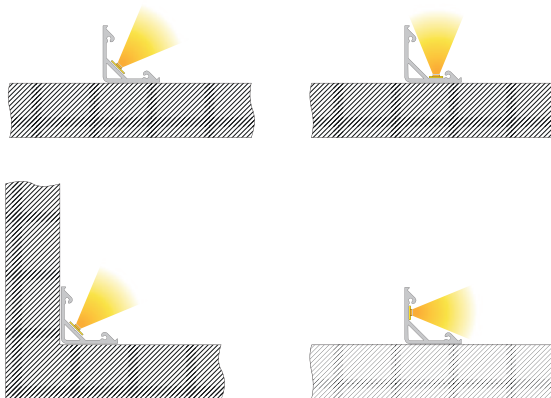
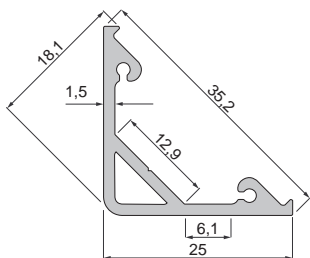

With the kind support of Alitherme Waldbrunn / Ziegler Technics buero@ziegler-technics.de

covers | PC [polycarbonate]
for 12 mm profiles

clear mat milky



2m
3m

983100 **23,95 €**
983101 **35,95 €**



2m
3m

984570 **23,95 €**
984571 **35,95 €**



2m
3m

985570 **23,95 €**
985571 **35,95 €**

end caps set | 2 pieces | aluminium **21,95 €**
for 12 mm profiles

■ silver

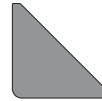

978370

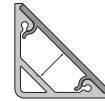

■ silver



979760



■ silver



980550

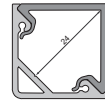

930105 310ml cartridge, white | glue+sealing power

35,95 €



930350 3M double-sided tape | 50 m x 25 mm

56,95 €

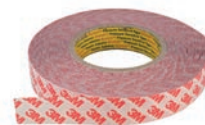

AV-05-15

corner-profile | 15 mm
for LED stripes up to 15,4 mm width



item	colour	dimensions L	price
970560	aluminium anodized	2m	49,95 €
970561	aluminium anodized	3m	79,95 €

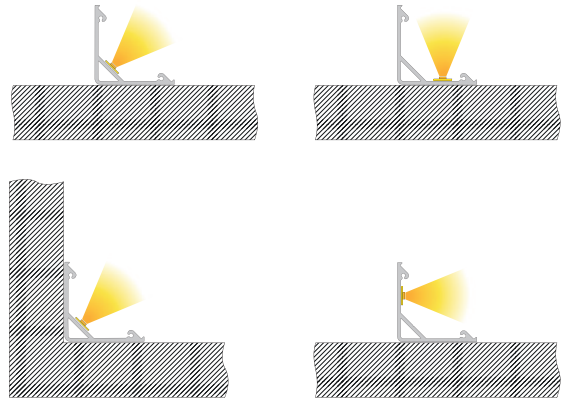
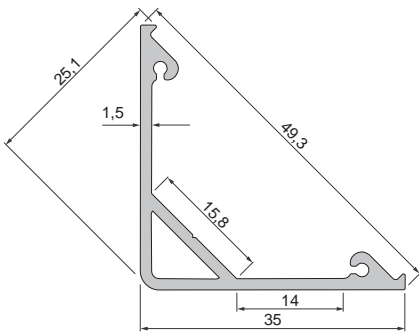

covers | PC [polycarbonate]
for 15 mm profiles

clear mat milky



2m

983110 **30,95 €**

3m

983111 **44,95 €**



2m

984580 **30,95 €**

3m

984581 **44,95 €**

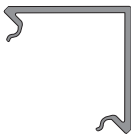

2m

985580 **30,95 €**

3m

985581 **44,95 €**

end caps set | 2 pieces | aluminium
for 15 mm profiles

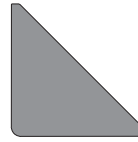

■ silver

978380

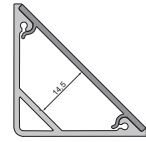

24,95 €

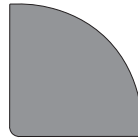

■ silver

979770

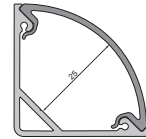

21,95 €

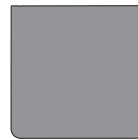

■ silver

980560

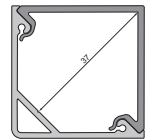

21,95 €

930105 310ml cartridge, white | glue+sealing power

35,95 €



930350 3M double-sided tape | 50 m x 25 mm

56,95 €

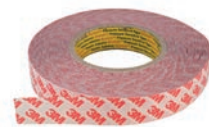

AV-05-25

corner-profile | suitable for rope suspension | 25 mm
for LED stripes up to 25,5 mm width



item	colour	dimensions L	price
970570	aluminium anodized	2m	69,95 €
970571	aluminium anodized	3m	99,95 €

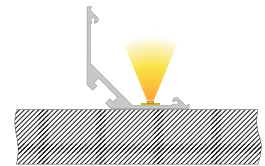
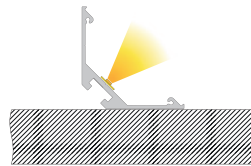
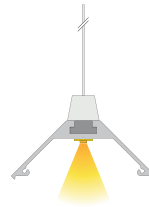
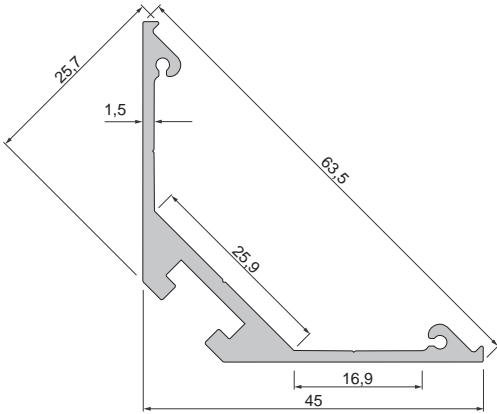

covers | PC [polycarbonate]
for 25 mm profiles

clear mat milky



2m
3m

983120 **35,95 €**
983121 **54,95 €**

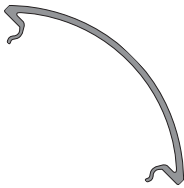

2m
3m

984590 **35,95 €**
984591 **54,95 €**

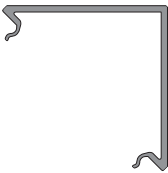

2m
3m

985590 **35,95 €**
985591 **54,95 €**

end caps set | 2 pieces | aluminium
for 25 mm profiles

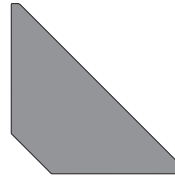

■ silver

978390

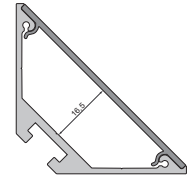

24,95 €

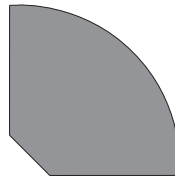

■ silver

979780

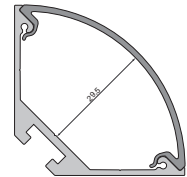

21,95 €

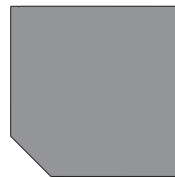

■ silver

980570

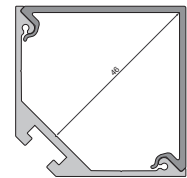

21,95 €

987060 wire suspension, pivotable, 2m | set | 2 pieces
For the installation of the wire suspension you need, depending on the profile, the universal sliding block 987020.

35,95 €



987020 universal sliding block/straight connector set | 2 pieces

7,95 €



930105 310ml cartridge, white | glue+sealing power

35,95 €



930350 3M double-sided tape | 50 m x 25 mm

56,95 €

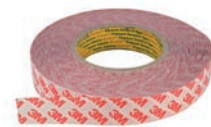



With the kind support of BEST Bellemann Elektro Service Team GmbH, Rauenberg-Malschenberg



dry construction profiles

Our dry construction profiles offer you full creative freedom. Redefine linear light – whether as a primary light or for accent lighting.

EL-02-12

dry construction profile for wall coving | 12 mm
for LED stripes up to 14 mm width



item	colour	dimensions L	price
975491	■ aluminium anodized	2m	82,95 €
975496	■ aluminium anodized	3m	124,95 €
975495	□ white	2m	82,95 €

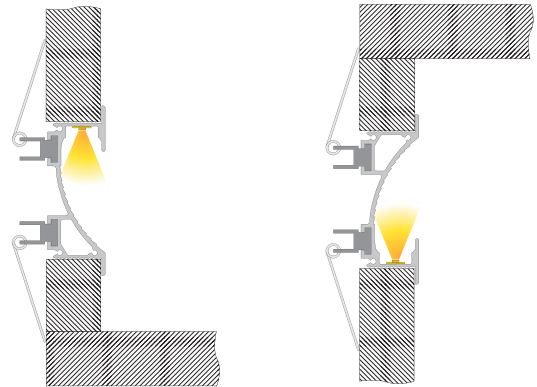
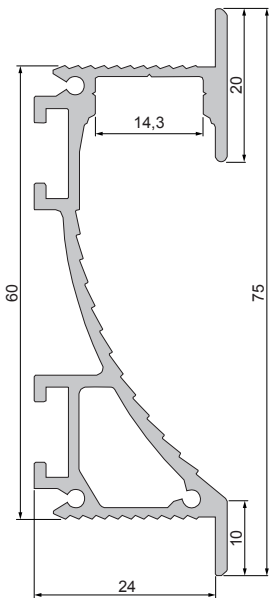

covers | PMMA [polymethylmethacrylat]
for 12 mm profiles

clear mat milky



1m	983020	983022	983024	7,95 €
2m	983021	983023	983025	17,95 €
3m	983028	983027	983026	25,95 €

end caps set | right + left **4,95 €**

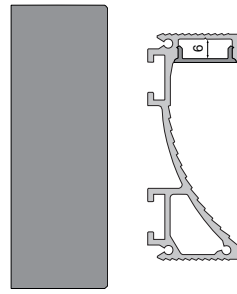

□ white **978250**
■ grey **978251**

end caps set | right + left | aluminium **35,95 €**



■ silver **978252**

930105 310ml cartridge, white | glue+sealing power **35,95 €**



987040 sliding block with springsset
set | 2 pieces **7,95 €**

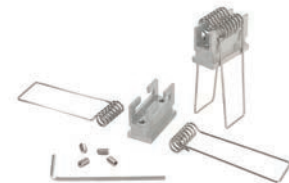

987020 universal sliding block/straight connector
set | 2 pieces **7,95 €**



ET-03-10

dry construction-built-in-T-profile | 10 mm
for LED stripes up to 12 mm width

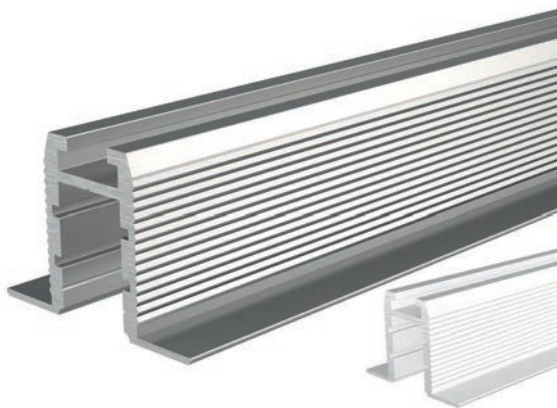

item	colour	dimensions L	price
975471	aluminium anodized	2,5m	59,95 €
975476	aluminium anodized	3m	75,95 €
975475	white	2,5m	59,95 €

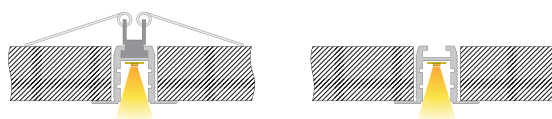
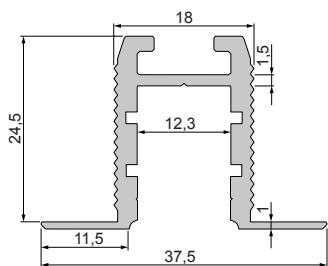

With the kind support of Friese Elektrotechnik, Ettenheim

covers | PMMA [polymethylmethacrylat]
for 10 mm profiles

clear mat milky



1m	983010	983012	983014	7,95 €
2m	983011	983013	983015	17,95 €
3m	983016	983017	983018	25,95 €
4m	983060	983061	983062	33,95 €



1m		984012	984014	7,95 €
2m		984013	984015	17,95 €
3m		984017	984018	25,95 €
4m		984010	984011	33,95 €



1m		984512	984514	7,95 €
2m		984513	984515	17,95 €
3m		984517	984518	25,95 €
4m		984510	984511	33,95 €

end caps set | 2 pieces **4,95 €**
for 10 mm profiles



	white	978260
	grey	978261

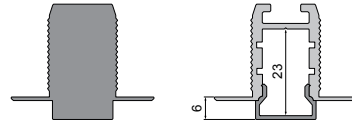

	white	979200
	grey	979201

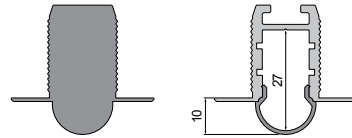

	white	979700
	grey	979701

970762 carrier profile for LED stripes
aluminium natural | 1,25m
to reduce the insertion depth of the LED stripe

7,95 €

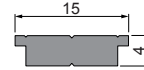

930105 310ml cartridge, white | glue+sealing power

35,95 €



987040 sliding block with springsset
set | 2 pieces

7,95 €

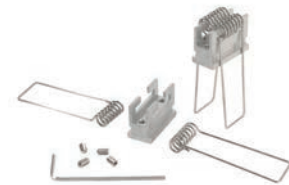

987020 universal sliding block/straight connector
set | 2 pieces

7,95 €



EL-03-10

dry construction profile for ceiling covers | 10 mm
for LED stripes up to 12 mm width

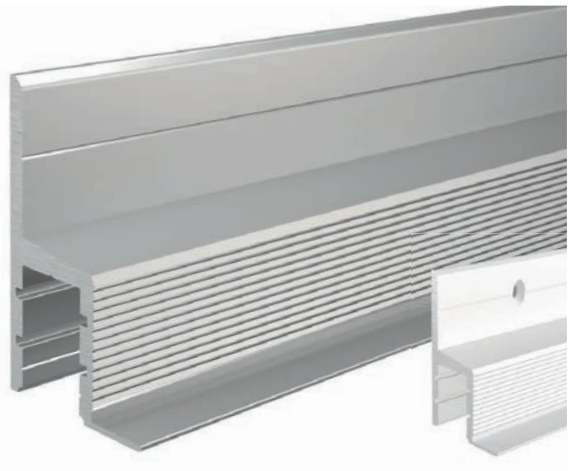

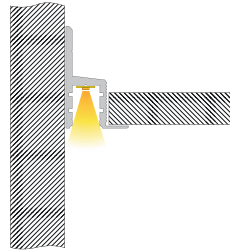
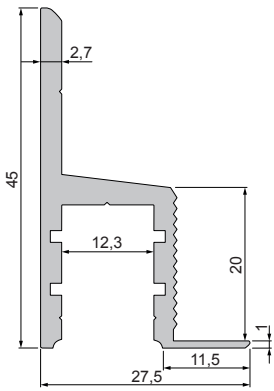

item	colour	dimensions L	price
975483	aluminium anodized	2m	59,95 €
975486	aluminium anodized	3m	94,95 €
975485	white	2,5m	79,95 €



covers | PMMA [polymethylmethacrylat]
for 10 mm profiles

clear mat milky



				
1m	983010	983012	983014	7,95 €
2m	983011	983013	983015	17,95 €
3m	983016	983017	983018	25,95 €
4m	983060	983061	983062	33,95 €

				
1m	984012	984014	984014	7,95 €
2m	984013	984015	984015	17,95 €
3m	984017	984018	984018	25,95 €
4m	984010	984011	984011	33,95 €

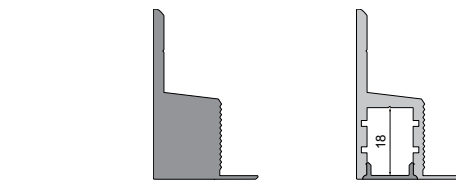

				
1m	984512	984514	984514	7,95 €
2m	984513	984515	984515	17,95 €
3m	984517	984518	984518	25,95 €
4m	984510	984511	984511	33,95 €

end caps set | right + left **4,95 €**



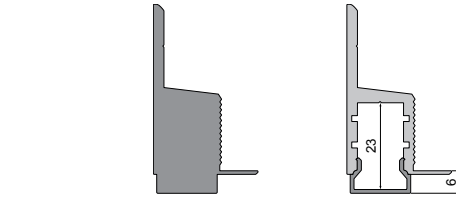

 white **978270**
 grey **978271**

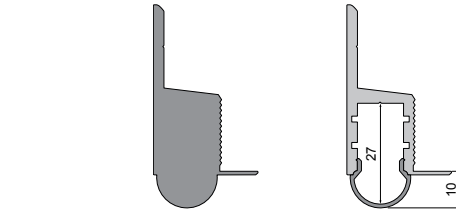

 white **979210**
 grey **979211**



 white **979710**
 grey **979711**

970762 carrier profile for LED stripes
aluminium natural | 1,25m
to reduce the insertion depth of the LED stripe

7,95 €

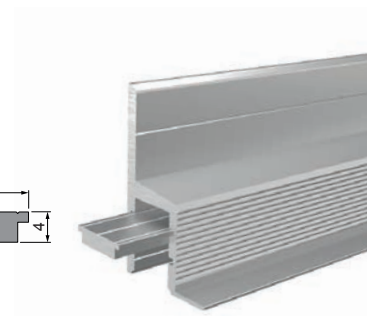
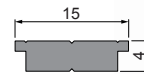

EU-01-36

dry construction-built-in-U-profile | 35 mm
for LED stripes up to 36 mm width

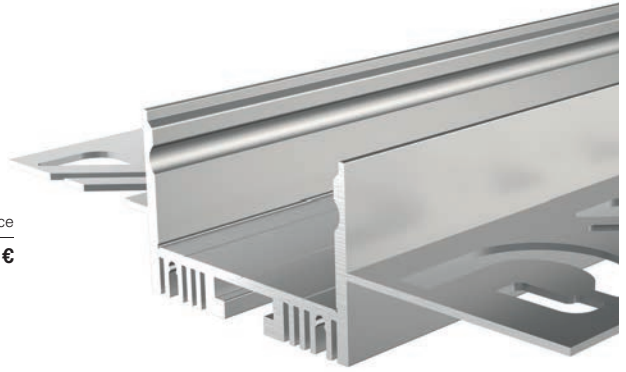

item	colour	dimensions L	price
975501	■ aluminium natural	3m	124,95 €

- optimised and designed for the built-in of 12.5 mm gypsum plasterboards
- easy to plaster thanks to optional inlay for protection
- increased passive cooling of the stripes due to cooling fins
- optimal for homogeneous bright light lines

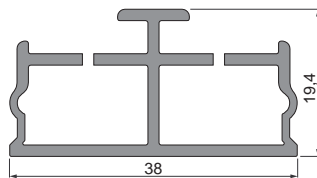
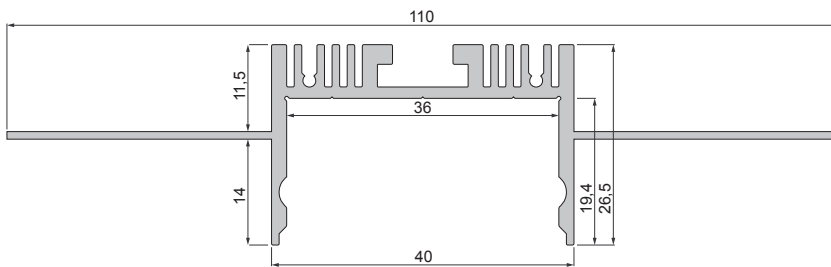

covers | PMMA [polymethylmethacrylat]
for 35 mm profiles

clear mat milky



3m

985601 **42,95 €**

 silver

978175

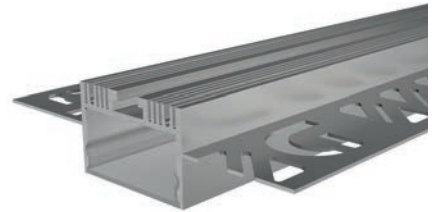
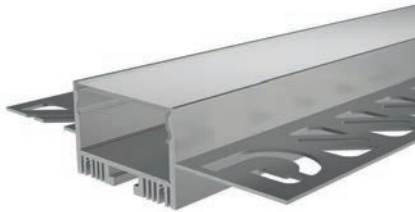
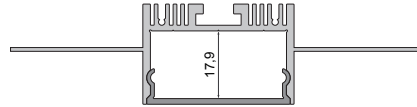

PROTECTION COVER

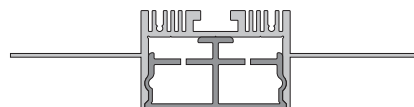
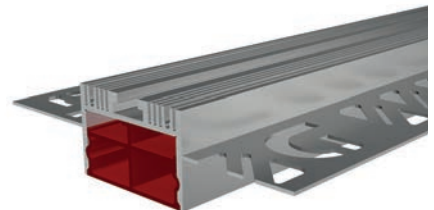
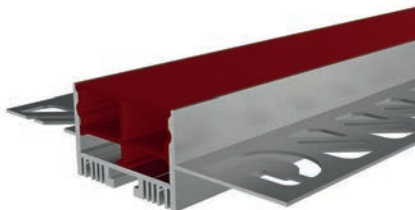

985605 inlay / dummy [reusable]
plastic | red | 3m
to protect against soiling during plastering

30,95 €



With the kind support of BEST Bellemann Elektro Service Team GmbH, Rauenberg-Malschenberg



tile profiles

Tile profiles play to every corner and closing area. Do away with conventional tile end profiles and set a new standard with linear light.

EL-01-08

tile profile | 8 mm
for LED stripes up to 9,3 mm width



item	colour	dimensions L	price
975331	aluminium anodized	2,5m	53,95 €
975334	aluminium anodized	3m	64,95 €

designed for tile thickness up to max. 9 mm

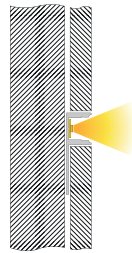
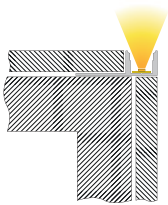
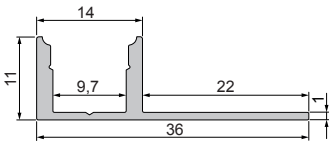

covers | PMMA [polymethylmethacrylat]
for 8 mm profiles

clear mat milky



1m	983000	983002	983004	7,95 €
2m	983001	983003	983005	17,95 €
3m	983006	983007	983008	25,95 €

end caps set | 2 pieces **4,95 €**
for 8 mm profiles



 grey **978211**



With the kind support of BEST Bellemann Elektro Service Team GmbH, Reuenberg-Malschenberg



EL-03-12

tile profile | 12 mm

for LED stripes up to 13,3 mm width

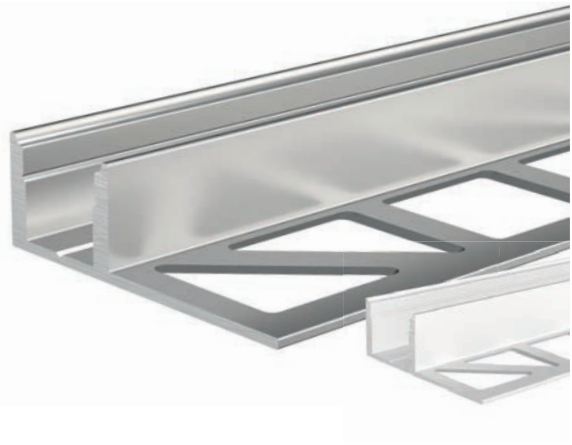

item	colour	dimensions L	price
975360	■ aluminium anodized	1,25m	28,95 €
975361	■ aluminium anodized	2,5m	59,95 €
975365	□ white	2,5m	59,95 €

designed for tile thickness up to max. 12 mm

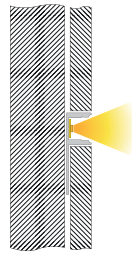
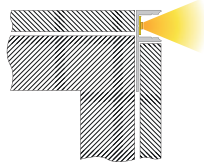
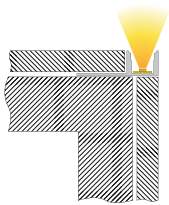
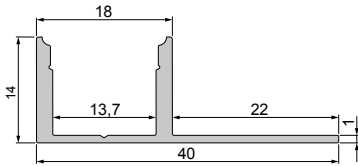

covers | PMMA [polymethylmethacrylat]
for 12 mm profiles

clear mat milky



1m	983020	983022	983024	7,95 €
2m	983021	983023	983025	17,95 €
3m	983028	983027	983026	25,95 €



1m		984022	984024	7,95 €
2m		984023	984025	17,95 €
3m			984026	25,95 €

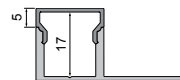

With the kind support of BEST Bellemann Elektro Service Team GmbH, Raunberg-Malschenberg

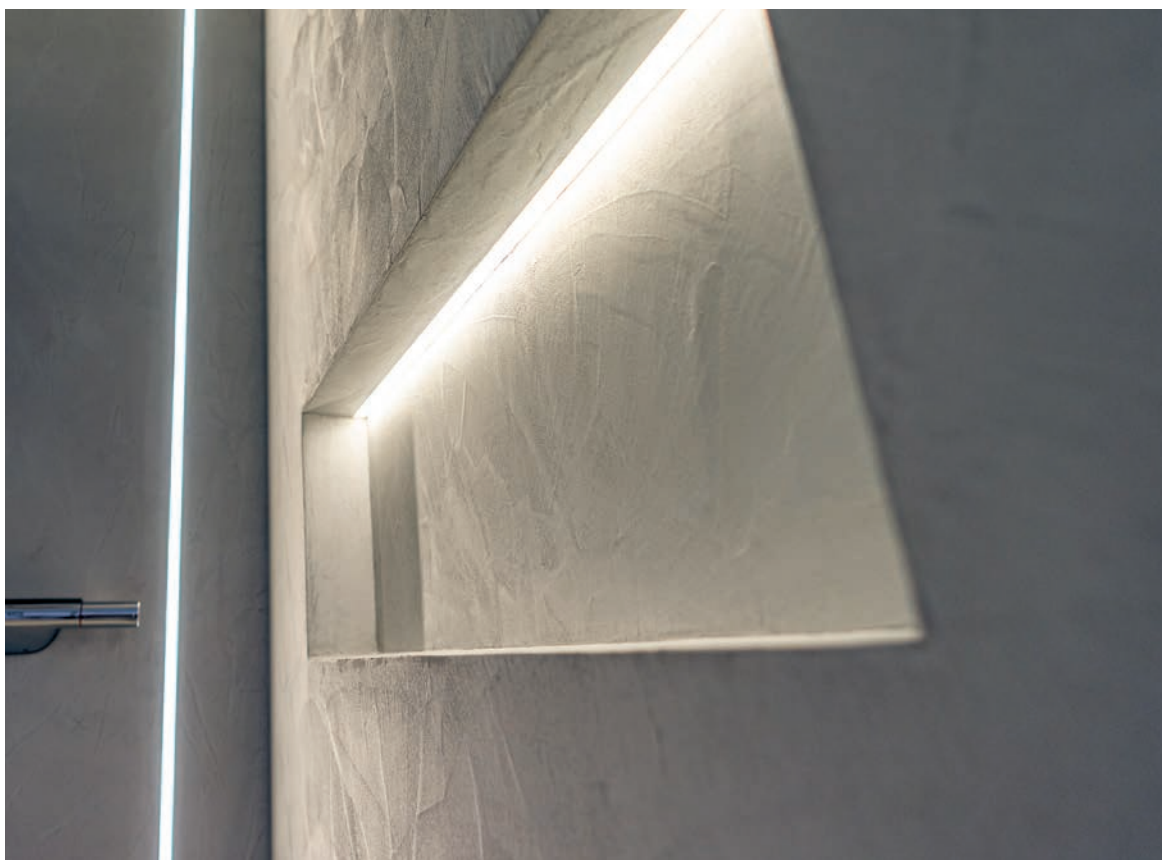

EA-03-12

tile-closing-profile | 12 mm
for LED stripes up to 13 mm width

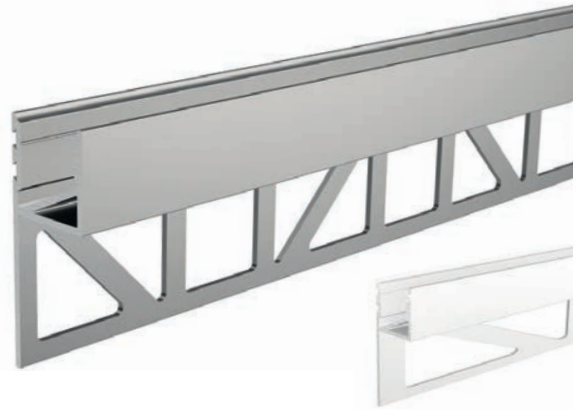

item	colour	dimensions L	price
975390	■ aluminium anodized	2m	38,95 €
975391	■ aluminium anodized	3m	59,95 €
975394	□ white	2m	38,95 €
975395	□ white	3m	59,95 €

designed for tile thickness up to max. 12 mm

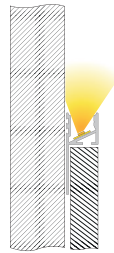
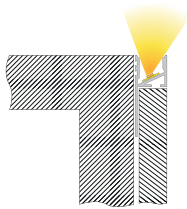
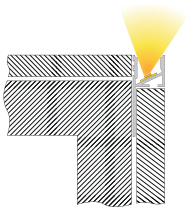
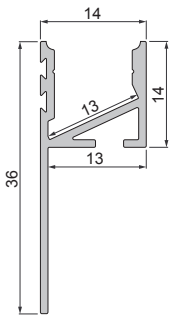

covers | PMMA [polymethylmethacrylat]
for 12 mm profiles

clear mat milky



1m	983000	983002	983004	7,95 €
2m	983001	983003	983005	17,95 €
3m	983006	983007	983008	25,95 €



1m		984002	984004	7,95 €
2m		984003	984005	17,95 €

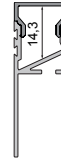
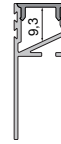

EV-01-08

tile-inside-corner-profile | 8 mm
for LED stripes up to 9,3 mm width

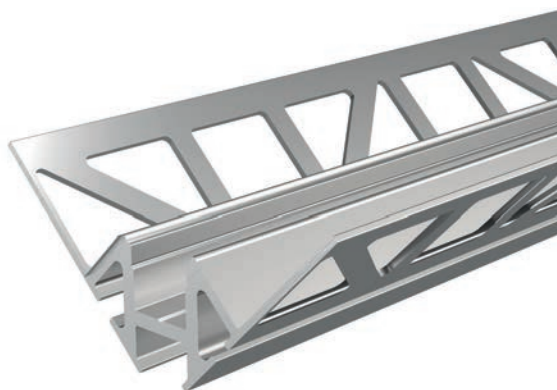

item	colour	dimensions L	price
975341	■ aluminium anodized	2,5m	79,95 €
975344	■ aluminium anodized	3m	99,95 €

designed for tile thickness up to max. 9 mm

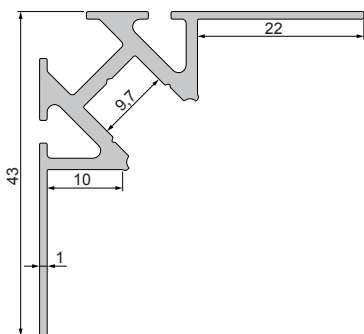

covers | PMMA [polymethylmethacrylat]
for 8 mm profiles

clear mat milky



1m	983000	983002	983004	7,95 €
2m	983001	983003	983005	17,95 €
3m	983006	983007	983008	25,95 €



1m		985504	7,95 €
2m		985505	17,95 €
3m		985508	25,95 €

end caps set | 2 pieces **4,95 €**
for 8 mm profiles

grey



978221

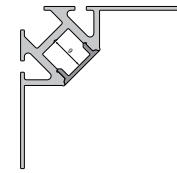

grey



980501

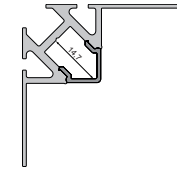

EV-01-12

tile-inside-corner-profile | 12 mm
for LED stripes up to 13,3 mm width

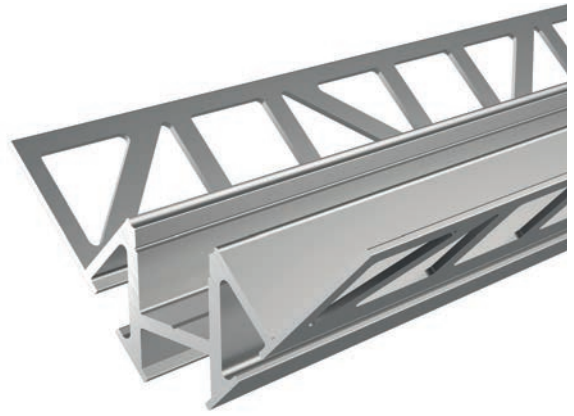

item	colour	dimensions L	price
975371	■ aluminium anodized	2,5m	99,95 €
975375	□ white	2,5m	99,95 €

designed for tile thickness up to max. 12 mm

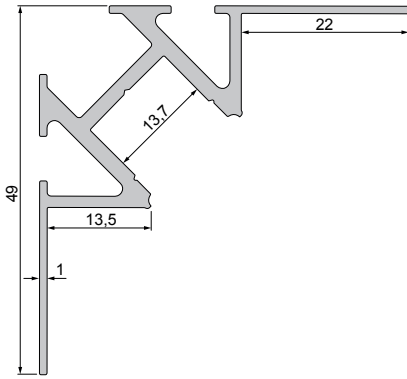

covers | PMMA [polymethylmethacrylat]
for 12 mm profiles

clear mat milky



1m	983020	983022	983024	7,95 €
2m	983021	983023	983025	17,95 €
3m	983028	983027	983026	25,95 €

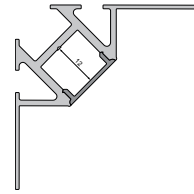

EV-02-08

tile-outside-corner-profile | 8 mm
for LED stripes up to 9,3 mm width

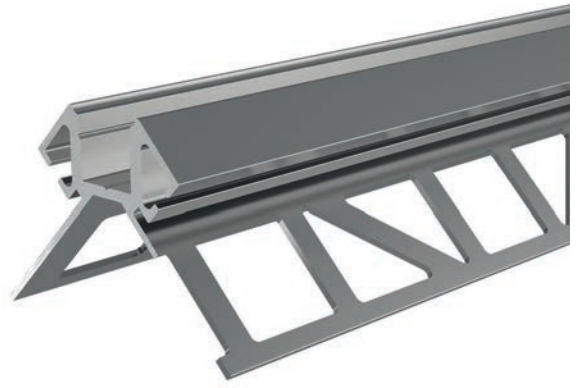

item	colour	dimensions L	price
975351	aluminium anodized	2,5m	79,95 €
975353	aluminium anodized	3m	99,95 €

designed for tile thickness up to max. 9 mm

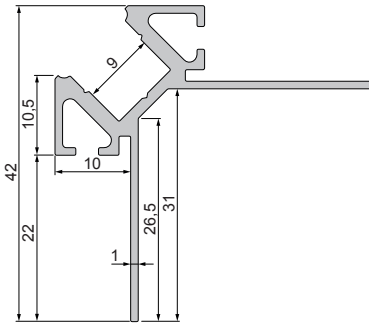

covers | PMMA [polymethylmethacrylat]
for 8 mm profiles

clear mat milky



1m	983000	983002	983004	7,95 €
2m	983001	983003	983005	17,95 €
3m	983006	983007	983008	25,95 €



1m		985504	7,95 €
2m		985505	17,95 €
3m		985508	25,95 €

end caps set | 2 pieces **4,95 €**
for 8 mm profiles

■ grey



978231

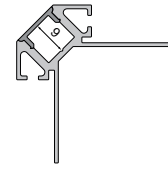

■ grey



980511

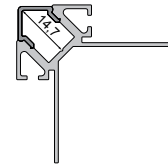

EV-02-12

tile-outside-corner-profile | 12 mm
for LED stripes up to 13,3 mm width

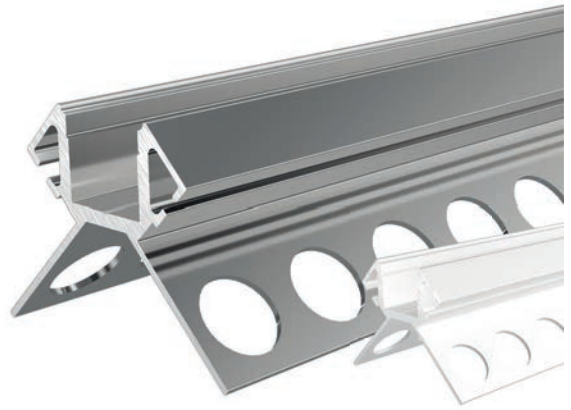

item	colour	dimensions L	price
975381	■ aluminium anodized	2,5m	99,95 €
975385	□ white	2,5m	99,95 €

designed for tile thickness up to max. 12 mm

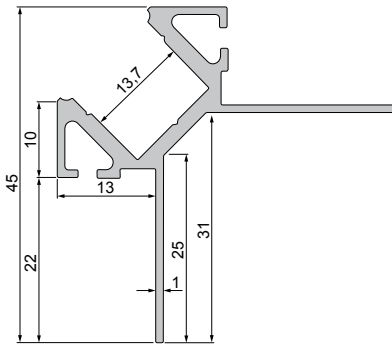

covers | PMMA [polymethylmethacrylat]
for 12 mm profiles

clear mat milky

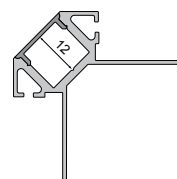

1m	983020	983022	983024	7,95 €
2m	983021	983023	983025	17,95 €
3m	983028	983027	983026	25,95 €





With the kind support of BEST Bellemann Elektro Service Team GmbH, Rauenberg-Malschenberg



profiles for outdoor use

Outdoor areas have different requirements than indoor areas. Our IP profiles are walkable and passable and inspire as a highlight in any outdoor design.

AU-04-12

IP-profile | walkable | 12 mm
for LED stripes up to 12,3 mm width



item	colour	dimensions L	price
970723	aluminium anodized	2m	23,95 €
970724	aluminium anodized	3m	35,95 €

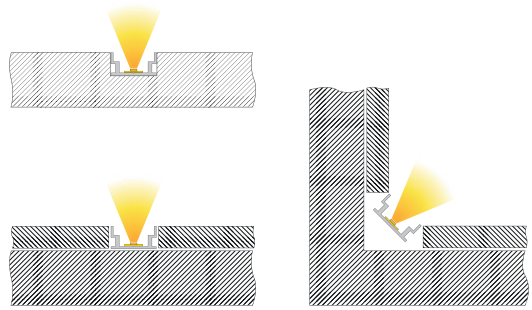
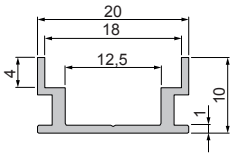

covers | Makrolon [polycarbonate]
 for 12 mm profiles
 walkable | material strength: 4mm
 optimum light diffusion | extremely impact resistant

end caps set | 2 pieces **4,95 €**
 for 12 mm profiles

clear mat milky



2m	988025	19,95 €
3m	988028	28,95 €

 grey



981001



! With professional processing, a protection class of up to IP65 can be achieved.

930104 natural stone sealant | 310ml cartridge
 transparent | for adhesion of cover **39,95 €**



930103 sealant smoothing agent | 400ml tin
 for clean stripping and to improve the surface of the sealant **39,95 €**



ET-05-12

IP-built-in-profile | walkable | 12 mm
for LED stripes up to 12,3 mm width

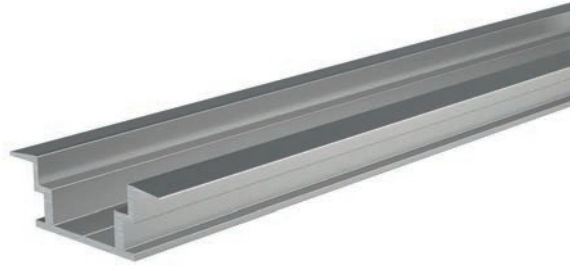

item	colour	dimensions L	price
975723	aluminium anodized	2m	23,95 €
975724	aluminium anodized	3m	35,95 €

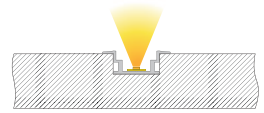
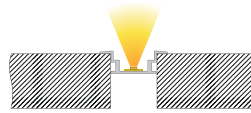
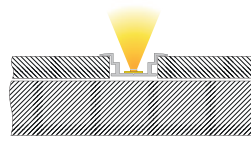
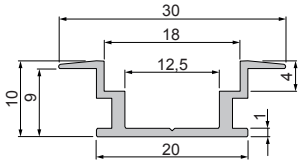

With the kind support of Oktec, Eisingen

covers | Makrolon [polycarbonate]
 for 12 mm profiles
 walkable | material strength: 4mm
 optimum light diffusion | extremely impact resistant

end caps set | 2 pieces **4,95 €**
 for 12 mm profiles

clear mat milky



2m	988025	19,95 €
3m	988028	28,95 €

 grey



981011

! With professional processing, a protection class of up to IP65 can be achieved.

930104 natural stone sealant | 310ml cartridge
 transparent | for adhesion of cover **39,95 €**



930103 sealant smoothing agent | 400ml tin
 for clean stripping and to improve the surface of the sealant **39,95 €**



AU-05-15

IP-profile | walkable | 15 mm
for LED stripes up to 15,6 mm width



item	colour	dimensions L	price
970741	aluminium natural	2m	42,95 €

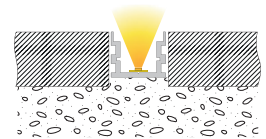
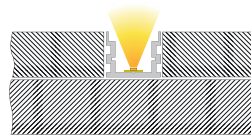
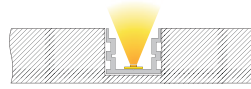
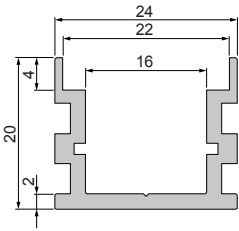

With the kind support of Elektro Grün, Neustadt an der Weinstraße

covers | Makrolon [polycarbonate]
 for 15 mm profiles
 walkable | material strength: 4mm
 optimum light diffusion | extremely impact resistant

clear mat milky



1m	988084	11,50 €
2m	988085	21,95 €

end caps set | 2 pieces **4,95 €**
 for 15 mm profiles

 grey



981031

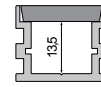

970764 carrier profile for LED stripes
 aluminium natural | 1m
 to reduce the insertion depth of the LED stripe

7,95 €

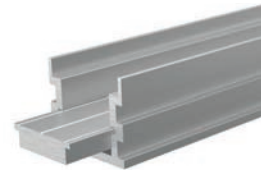

! With professional processing, a protection class of up to IP65 can be achieved.

930104 natural stone sealant | 310ml cartridge
 transparent | for adhesion of cover

39,95 €



930103 sealant smoothing agent | 400ml tin
 for clean stripping and to improve the surface of the sealant

39,95 €



ET-05-15

IP-built-in-T-profile | walkable | 15 mm
for LED stripes up to 15,6 mm width

item	colour	dimensions L	price
975741	aluminium natural	2m	42,95 €

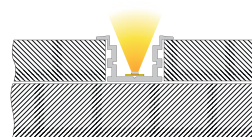
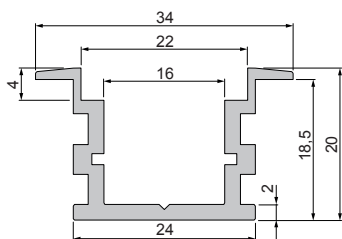
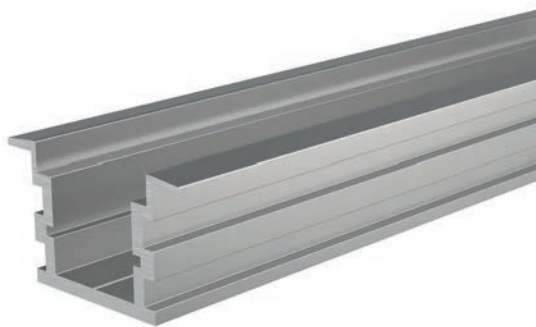

With the kind support of LED-TEC, Gira/Italien | Foto: fotoeichhorn

covers | Makrolon [polycarbonate]
 for 15 mm profiles
 walkable | material strength: 4mm
 optimum light diffusion | extremely impact resistant

clear mat milky



1m	988084	11,50 €
2m	988085	21,95 €

end caps set | 2 pieces **4,95 €**
 for 15 mm profiles

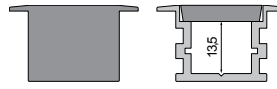

 grey **981041**

970764 carrier profile for LED stripes
 aluminium natural | 1m
 to reduce the insertion depth of the LED stripe

7,95 €

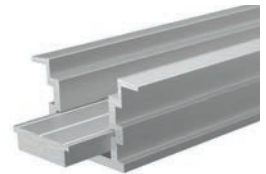
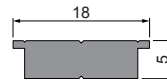

! With professional processing, a protection class of up to IP65 can be achieved.

930104 natural stone sealant | 310ml cartridge
 transparent | for adhesion of cover

39,95 €



930103 sealant smoothing agent | 400ml tin
 for clean stripping and to improve the surface of the sealant

39,95 €



EU-01-12

IP-built-in-profile | passable | 12 mm
for LED stripes up to 12 mm width



item	colour	dimensions L	price
975781	■ aluminium natural	2m	79,95 €

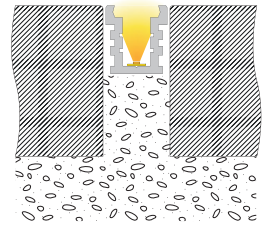
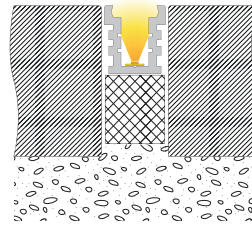
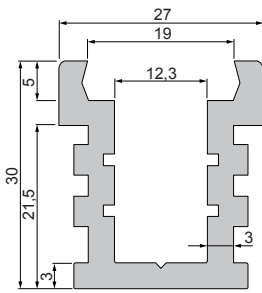

covers | Makrolon [polycarbonate]
 for 12 mm profiles
 passable | material strength: 5mm
 optimum light diffusion | extremely impact resistant

clear mat milky



1m	988054	11,50 €
2m	988055	21,95 €

end caps set | 2 pieces **4,95 €**
 for 12 mm profiles

 grey

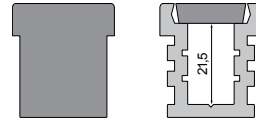

981021

970762 carrier profile for LED stripes
 aluminium natural | 1,25m
 to reduce the insertion depth of the LED stripe

7,95 €

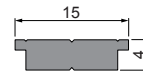

990109 foam support | 123,5 x 3,3 x 3 cm
 plastic | hard foam
 for relining the profile

7,95 €



! With professional processing, a protection class of up to IP65 can be achieved.
 Can be driven over with a maximum load of 1 tonne. We recommend our matching foam underlay.

930104 natural stone sealant | 310ml cartridge
 transparent | for adhesion of cover

39,95 €



930103 sealant smoothing agent | 400ml tin
 for clean stripping and to improve the surface of the sealant

39,95 €





LED STRIPES

- 656 LED stripes | overview
- 658 technical information
- 660 quick finder
- 664 COB | 1CH | 24V
- 668 COB sauna | 1CH | 24V
- 670 COB | 2CH | 24V
- 672 COB | 3CH | 24V
- 674 standard | 1CH | 12V / 24V / 48V
- 686 standard | 2CH | 12V / 24V
- 692 standard | 3CH | 24V / 48V
- 698 standard | 4CH | 24V
- 702 D FLEX LINE top-view | 1CH / 3CH / 4CH | 24V
- 710 D FLEX LINE side-view | 1CH / 4CH | 24V
- 716 230V | 1CH



WW NW

COB stripes

1CH | 24V
from page 664



WW

COB sauna

1CH | 24V
from page 668



WW CW

COB stripes

2CH | 24V
from page 670



RGB

COB stripes

3CH | 24V
from page 672



WW NW CW

standard stripes

1CH | 12V
from page 674



WW NW CW

standard stripes

1CH | 24V
from page 676



WW NW

standard stripes

1CH | 48V
from page 682



WW CW

standard stripes

2CH | 12V
from page 686



WW CW

standard stripes

2CH | 24V
from page 688



RGB

standard stripes

3CH | 48V
from page 696



RGB

standard stripes

3CH | 24V
from page 692



RGB WW NW

standard stripes

4CH | 24V
from page 698



ww

D FLEX LINE TOP-VIEW

1CH | 24V
from page 702



RGB

D FLEX LINE TOP-VIEW

3CH | 24V
page 706



RGB ww

D FLEX LINE TOP-VIEW

4CH | 24V
page 708



ww

D FLEX LINE SIDE-VIEW

1CH | 24V
from page 710



RGB ww

D FLEX LINE SIDE-VIEW

4CH | 24V
page 714



ww nw

230V stripes

1CH
page 716

LED stripes

THINGS TO KNOW ABOUT LED STRIPES

Which LED chips and sizes are most commonly installed in our company?

On these two pages, we focus on LED stripes, or more precisely on the LED chips installed on them. These are installed in a wide variety of sizes, power classes, quantities and distances for a wide variety of stripes in 12V, 24V, 48V and 230V.

quality promise

Our LED stripes are subjected to constant quality control during production. Thus, we can guarantee the high quality of our LED stripes.

STRUCTURE OF A STANDARD LED CHIP

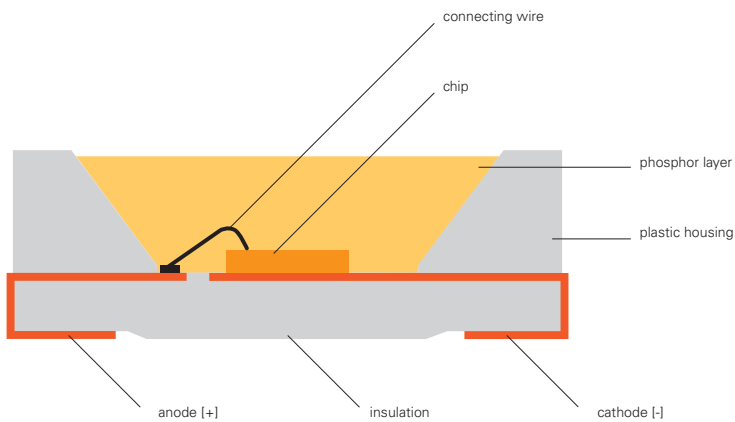

WHAT DO THE NUMBERS MEAN FOR A LED STRIPE?

The numbers clearly indicate the size [width and length] and shape of the LED chips installed on a carrier [stripe]. For example, the LED chip 5050 – one of the world's most

frequently used LED chips – has a width of LED chips – each with a length and width of 5 mm. A 2835 LED chip therefore has a width of 2.8 mm and a length of 3.5 mm.

SMD 5050 | single
chip dimensions: 5 x 5 mm

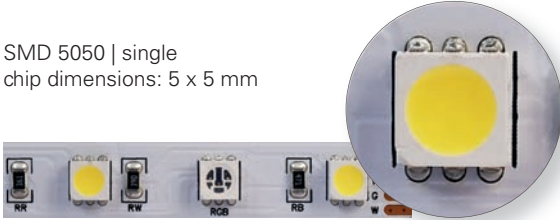

SMD 2835 | single
chip dimensions: 2,8 x 3,5 mm

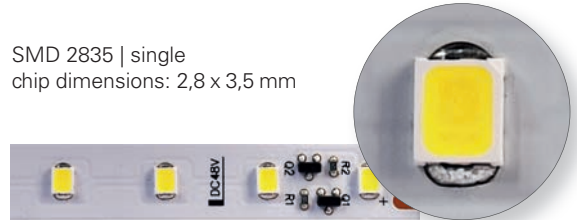

SMD 5050 | RGB
chip dimensions: 5 x 5 mm

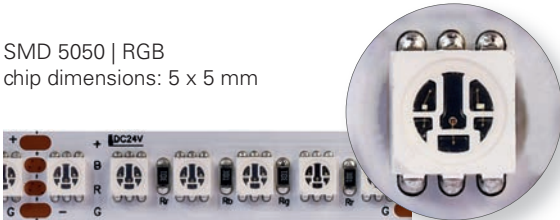

SMD 2835 | WW / CW
chip dimensions: 2,8 x 3,5 mm



SMD 5050 | WW / CW
chip dimensions: 5 x 5 mm



SMD 2216 | single
chip dimensions: 1,6 x 2,2 mm

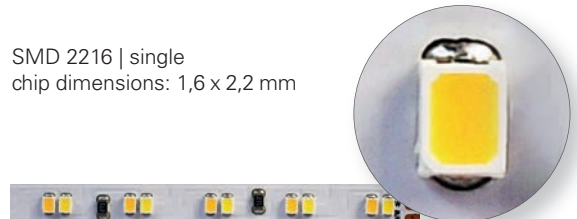

SMD 3528 | single
chip dimensions: 2,8 x 3,5 mm

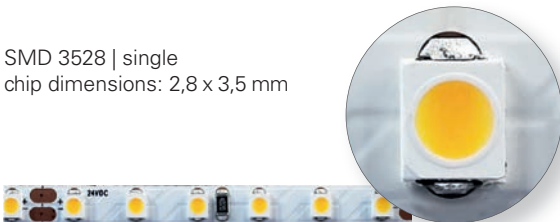

SMD 1808 | single
chip dimensions: 0,8 x 1,8 mm

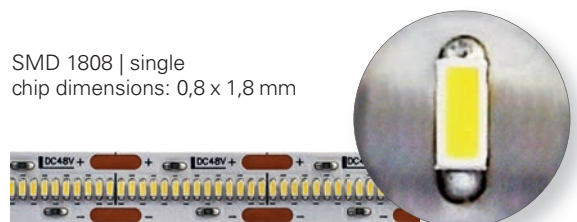

COB | single

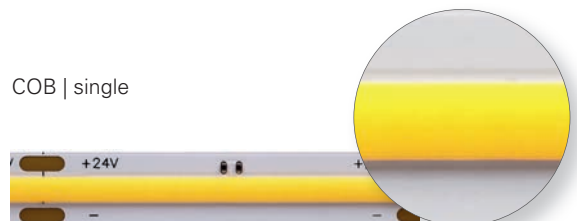

width in mm	voltage [DC]	W / m	type	light colour	colour temperature	lm / m	LED / m	length in mm	protection class	item number	page
4,0	24V	11,0	standard	ww	2700K	995	266	5000	IP20	840175	678
4,0	24V	11,0	standard	ww	3000K	1090	266	5000	IP20	840210	678
4,0	24V	11,5	standard	nw	4000K	1100	266	5000	IP20	840267	678
5,0	24V	8,5	standard	ww	2700K	680	120	5000	IP20	840158	677
5,0	24V	10,5	standard	ww	3000K	730	120	5000	IP20	840159	677
5,0	24V	11,0	standard	RGB		500	120	5000	IP20	840276	693
6,5	24V	9,5	D FLEX side view	ww	3000K	287	120	5000	IP44	840376	711
7,0	24V	8,0	D FLEX side view	ww	3000K	295	120	5000	IP68	840283	712
7,0	24V	12,5	standard	ww cw	3000-6500K	1070	196	5000	IP67	840349	690
8,0	12V	6,5	standard	ww	3000K	555	120	5000	IP20	840165	675
8,0	12V	7,0	standard	ww	2700K	570	120	5000	IP20	840164	675
8,0	12V	7,0	standard	cw	6500K	630	120	5000	IP20	840167	675
8,0	12V	7,0	standard	nw	4000K	670	120	5000	IP20	840166	675
8,0	12V	10,0	standard	ww cw	3000-6500K	760	120	5000	IP20	840097	687
8,0	24V	11,0	standard	ww cw	3000-6500K	1025	196	5000	IP20	840350	689
8,0	24V	13,5	standard	ww	3000K	1100	180	5000	IP20	840179	678
8,0	24V	13,5	standard	ww	3000K	1100	180	50000	IP20	930512	678
8,0	24V	13,5	standard	nw	4000K	1220	180	5000	IP20	840180	678
8,0	24V	13,5	standard	nw	4000K	1225	180	50000	IP20	930513	678
8,0	24V	14,0	standard	ww	2700K	1110	180	5000	IP20	840178	678
9,5	24V	10,0	D FLEX top view	RGB		315	120	5000	IP68	840286	707
9,5	24V	10,5	D FLEX top view	ww	3000K	730	144	5000	IP68	840285	703
10,0	24V	17,2	standard	ww cw	2700-6500K	1765	140	5000	IP20	840378	689
10,0	24V	14,0	standard	ww cw	2700-6500K	1470	140	5000	IP44	840379	690
10,0	48V	4,0	standard	ww	3000K	400	78	15000	IP44	840317	683
10,0	48V	4,0	standard	ww	3000K	405	78	50000	IP44	840338	683
10,0	48V	4,0	standard	nw	4000K	455	78	15000	IP44	840319	683
10,0	48V	4,0	standard	nw	4000K	455	78	50000	IP44	840340	683

width in mm	voltage [DC]	W / m	type	light colour	colour temperature	lm / m	LED / m	length in mm	protection class	item number	page
10,0	48V	4,0	standard	ww	3000K	485	78	15000	IP20	840318	683
10,0	48V	4,0	standard	ww	3000K	485	78	50000	IP20	840337	683
10,0	48V	4,0	standard	nw	4000K	530	78	15000	IP20	840320	683
10,0	48V	4,0	standard	nw	4000K	530	78	50000	IP20	840339	683
10,0	24V	9,5	standard	ww	3000K	705	120	10000	IP20	840291	677
10,0	24V	10,5	COB	ww cw	2700-6500K	960	576	5000	IP20	840374	671
10,0	12V	10,5	standard	ww cw	3000-6500K	1025	120	5000	IP20	840142	687
10,0	24V	12,0	COB	nw	4000K	1130	480	5000	IP20	840304	665
10,0	24V	12,5	COB	ww	3000K	1120	480	5000	IP20	840296	665
10,0	24V	13,0	standard	rgb		580	60	5000	IP20	840254	693
10,0	24V	14,0	standard	rgb		665	96	5000	IP20	840147	694
10,0	24V	14,5	standard	rgb		665	96	50000	IP20	930516	694
10,0	24V	16,0	COB	ww	3000K	2230	480	5000	IP20	840323	665
10,0	24V	16,0	COB	nw	4000K	2565	480	5000	IP20	840324	665
10,0	24V	16,0	standard	rgb ww	3000K	820	60	5000	IP20	840236	699
10,0	24V	16,0	standard	rgb ww	3000K	820	60	50000	IP20	930517	699
10,0	24V	16,5	standard	rgb nw	4000K	775	60	5000	IP20	840353	700
10,0	24V	16,5	COB	rgb		660	840	5000	IP20	840375	673
10,0	24V	16,0	standard	rgb nw	4000K	765	60	5000	IP44	840373	701
10,0	24V	18,5	standard	ww	2700K	1215	240	5000	IP20	840192	679
10,0	24V	19,0	standard	ww	3000K	1605	240	5000	IP20	840193	679
10,0	24V	19,0	standard	ww	3000K	1605	240	50000	IP20	930514	679
10,0	24V	20,0	standard	nw	4000K	1770	240	5000	IP20	840194	679
10,0	24V	20,0	standard	nw	4000K	1770	240	50000	IP20	930515	679
10,0	24V	20,0	standard	cw	6000K	1720	120	5000	IP20	840124	680
10,0	24V	21,0	standard	ww	3000K	1595	120	5000	IP20	840122	680
10,0	24V	22,5	standard	ww	3000K	2520	160	5000	IP44	840333	681
10,0	24V	22,5	standard	nw	4000K	2555	160	5000	IP44	840334	681

width in mm	voltage [DC]	W / m	type	light colour	colour temperature	lm / m	LED / m	length in mm	protection class	item number	page
10,0	24V	22,5	standard	ww	4000K	2815	160	5000	IP20	840332	680
10,0	24V	22,5	standard	ww	3000K	2570	160	5000	IP20	840331	680
10,5	12V	7,0	standard	ww	2700K	550	120	5000	IP67	840172	675
10,5	24V	11,5	standard	ww	2700K	900	180	5000	IP67	840186	681
10,5	24V	11,0	standard	ww	3000K	930	180	5000	IP67	840187	681
12,0	24V	10,5	D FLEX side view	ww	3000K	368	144	5000	IP68	840287	713
12,0	24V	10,5	D FLEX side view	RGB ww	3200K	210	84	5000	IP68	840290	715
12,0	24V	14,0	standard	RGB ww	3000K	585	96	5000	IP20	840144	699
12,0	24V	22,0	standard	RGB ww	3000K	955	192	5000	IP20	840308	700
12,0	24V	22,0	standard	RGB nw	4000K	985	192	5000	IP20	840309	700
12,0	24V	27,5	standard	RGB		1045	120	5000	IP44	840351	695
12,0	24V	28,0	standard	RGB		1055	120	5000	IP20	840352	694
12,5	24V	12,5	standard	RGB		530	60	5000	IP67	840256	695
12,5	24V	15,0	COB	ww	3000K	2225	480	5000	IP67	840321	666
12,5	24V	15,0	COB	nw	4000K	2455	480	5000	IP67	840322	666
12,5	24V	15,0	standard	RGB ww	3000K	735	60	5000	IP67	840239	701
16,0	24V	10,5	D FLEX top view	RGB ww	3200K	320	84	5000	IP68	840289	709
16,5	24V	10,5	D FLEX top view	ww	3000K	515	144	5000	IP68	840288	705
17,2	230V	14,0		ww	2700K	1442	84	15000	IP65	840390	717
17,2	230V	14,0		ww	2700K	1442	84	50000	IP65	840391	717
17,2	230V	14,0		ww	3000K	1470	84	15000	IP65	840386	717
17,2	230V	14,0		ww	3000K	1470	84	50000	IP65	840387	717
17,2	230V	14,0		nw	4000K	1596	84	15000	IP65	840388	717
17,2	230V	14,0		nw	4000K	1596	84	50000	IP65	840389	717

quick finder sorted in ascending order by width and performance



Foto: Daniel Vrieser - Architektur fotografie, Karlsruhe

COB | 1CH | 24V

COB stripes in warm white 3000K und neutral white 4000K
These LED stripes are ideal when the focus is on a homogeneous light pattern.



COB-480-24V-3000K / 4000K-5M

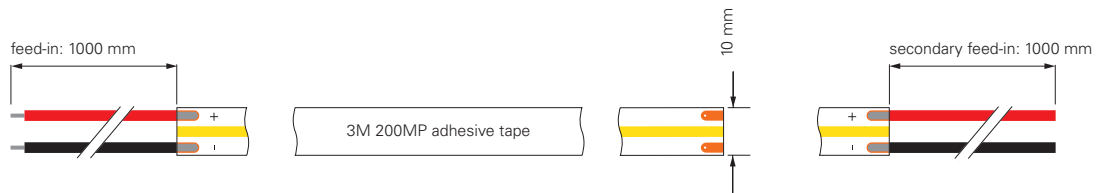
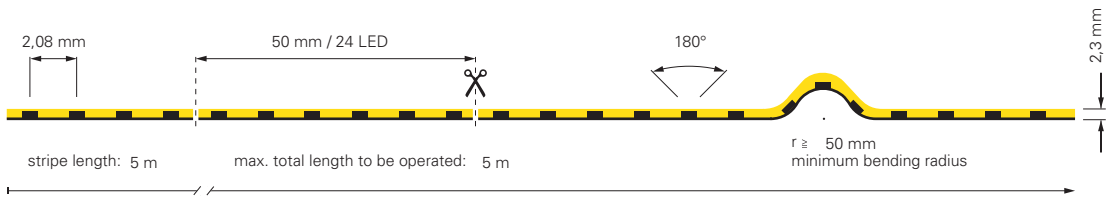

item	colour temperature	efficiency	light current	dimensions L	power	light source	price
840296	WW 3000K	90 lm/W	1120 lm/m	5000 mm	12,5 W/m	480 LED/m	159,95 €
840304	NW 4000K	94 lm/W	1130 lm/m	5000 mm	12,0 W/m	480 LED/m	159,95 €

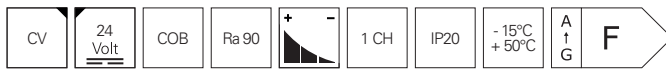

COB-480-24V-3000K / 4000K-5M

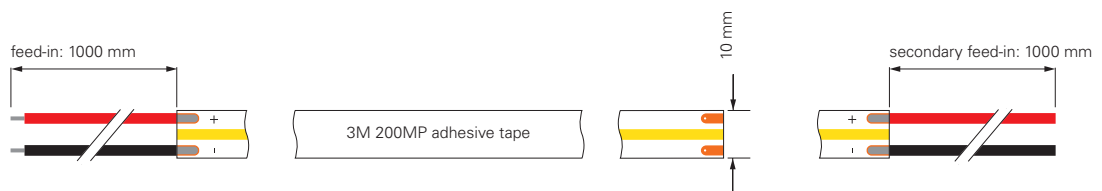
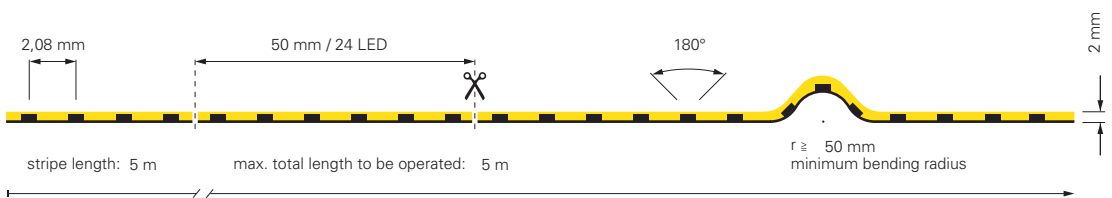

item	colour temperature	efficiency	light current	dimensions L	power	light source	price
840323	WW 3000K	139 lm/W	2230 lm/m	5000 mm	16 W/m	480 LED/m	179,95 €
840324	NW 4000K	160 lm/W	2565 lm/m	5000 mm	16 W/m	480 LED/m	179,95 €



COB-480-24V-3000K / 4000K-5M-SILIKON

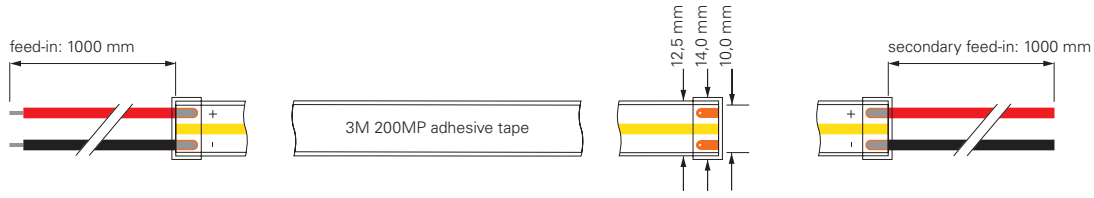
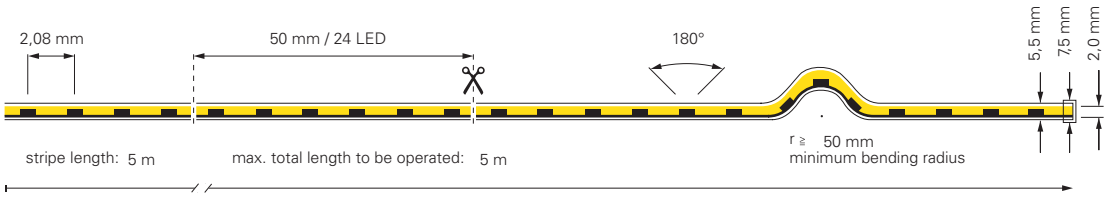

item	colour	temperature	efficiency	light current	dimensions L	power	light source	price
840321	ww	3000K	148 lm/W	2225 lm/m	5000 mm	15 W/m	480 LED/m	199,95 €
840322	nw	4000K	164 lm/W	2455 lm/m	5000 mm	15 W/m	480 LED/m	199,95 €

CV

24 Volt

COB

Ra 90

1 CH

IP67

-15°C
+50°C

A
↑
G

G

incl. accessories: 10x retaining bracket, 20x stainless steel screw, 2x endcap



Foto: Daniel Vieser - Architekturfotografie, Karlsruhe

COB SAUNA | 1CH | 24V

Our COB-SAUNA 24V LED stripes are the perfect lighting solution for saunas and steam baths. With an impressive lifetime of up to 75,000 hours for L70B50 and 50,000 hours for L80B10, these LED stripes offer a long-term lighting solution for your needs. In addition, the LED strip has an extra-long supply cable to provide you with maximum flexibility during installation. Item numbers 840409 and 840411 offer a 1.8 metre primary feed, while item numbers 840410 and 840412 offer both a 1.8 metre primary and secondary feed. The LED strip is permanently temperature resistant up to 105°C and has been developed especially for use in saunas and steam baths. Enjoy reliable lighting that withstands extreme temperatures while creating a pleasant atmosphere. As we have set ourselves the goal of becoming climate-neutral, the COB sauna LED stripes are packaged in an environmentally friendly paper-based way.

Important note regarding installation: It is not permitted to install the COB Sauna LEDStripes on aluminium or metal profiles! Installation is only permitted with the plastic profiles and silicone clips listed in the accessories!





COB-SAUNA-24V

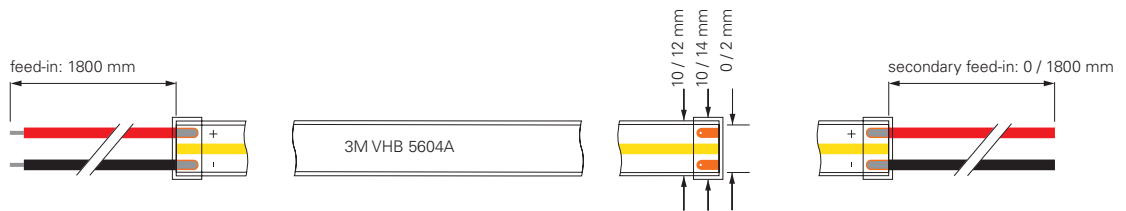
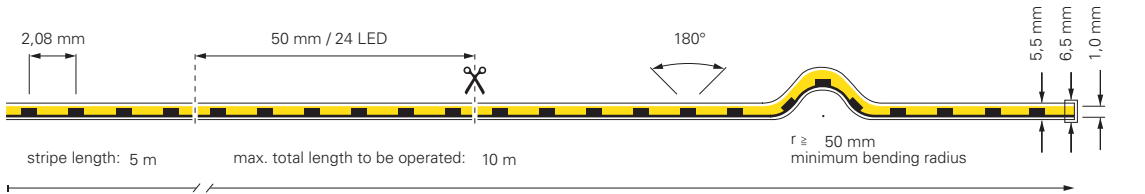

item	colour	temperature	efficiency	light current	dimensions L	power	light source	price
840409	ww	2700K	85 lm/W	850 lm/m	2000 mm	10 W/m	480 LED/m	99,95 €
840411	ww	2700K	85 lm/W	850 lm/m	5000 mm	10 W/m	480 LED/m	224,95 €
840410	ww	3000K	90 lm/W	900 lm/m	2000 mm	10 W/m	480 LED/m	99,95 €
840412	ww	3000K	90 lm/W	900 lm/m	5000 mm	10 W/m	480 LED/m	224,95 €



930736	silicone end caps set 2 pieces	0,95 €
930737	feed-in cable	12,95 €
930738	connector	17,95 €
930739	silicone clamps	1,95 €
930740	plastic profile 100cm	4,95 €
930741	plastic profile 200cm	9,95 €

COB | 2CH | 24V

COB stripe in warm white 2700K – cold white 6500K
These LED stripes are ideal when the focus is on a homogeneous light pattern. With these COB stripes, you have the option of mixing white tones between 2700K and 6500K through flexible control.





COB-576-24V-2700-6500K-5M

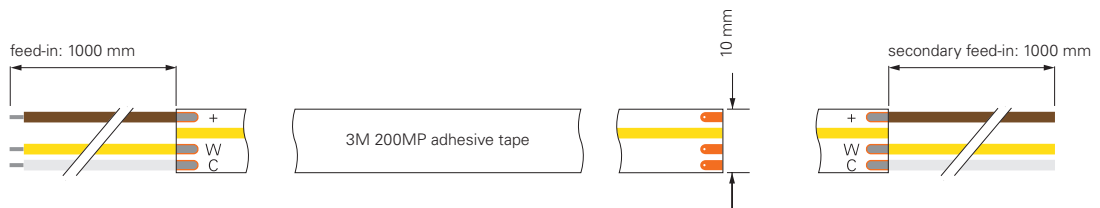
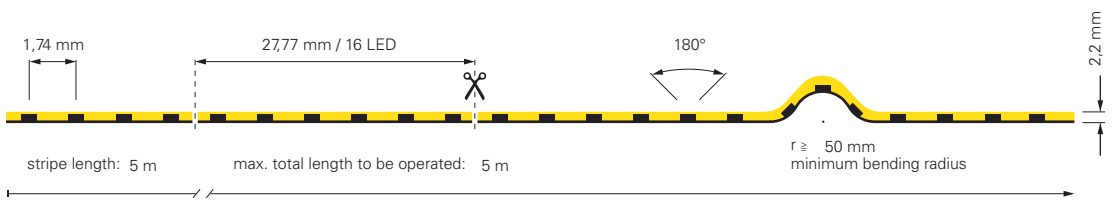

item	colour temperature	efficiency	light current	dimensions L	power	light source	price
840374	WW CW 2700-6500K	91 lm/W	960 lm/m	5000 mm	10,5 W/m	576 LED/m	299,95 €

CV

24 Volt

COB

Ra 90

IP20

-15°C
+50°C

A
↑
G

E

COB | 3CH | 24V

COB stripe in RGB

These LED stripes are ideal when the focus is on a homogeneous light pattern. With these COB stripes, you have the option of setting individual colours or mixed colours as desired through flexible control.



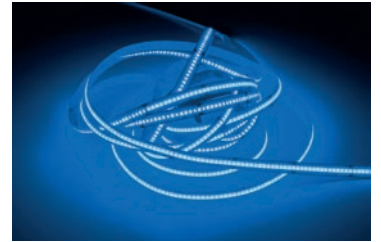
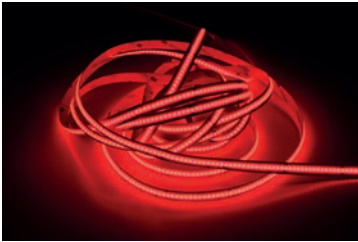

COB-840-24V-RGB-5M

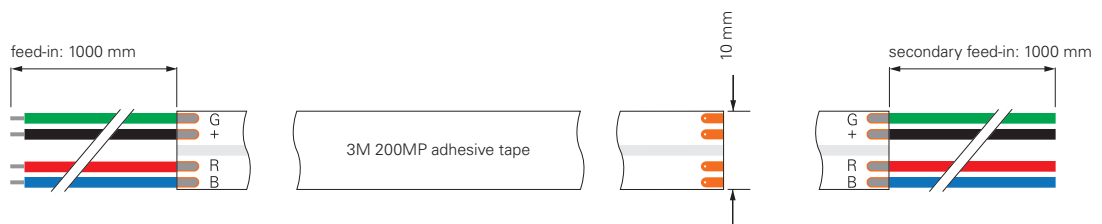
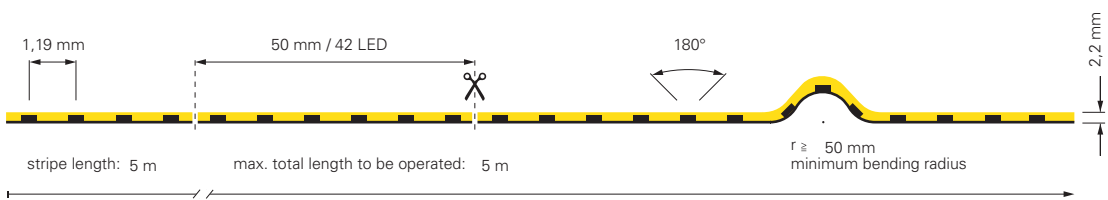

item	colour temperature	efficiency	light current	dimensions L	power	light source	price
840375	RGB 460-620 nm	40 lm/W	660 lm/m	5000 mm	16,5 W/m	840 LED/m	399,95 €



STANDARD | 1CH | 12V

LED stripes in warm white 2700K + 3000K, neutral white 4000K and cold white 6500K
These LED stripes are ideally suited for all standard applications and special assemblies with the most diverse requirements. With voltages of 12V, different protection classes, lumens, number of LEDs, power and much more, you will find the right LED stripe for your application.



3528-120-12V-2700K / 3000K / 4000K / 6500K-5M

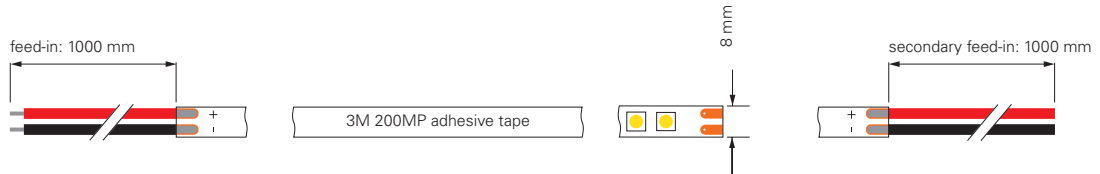
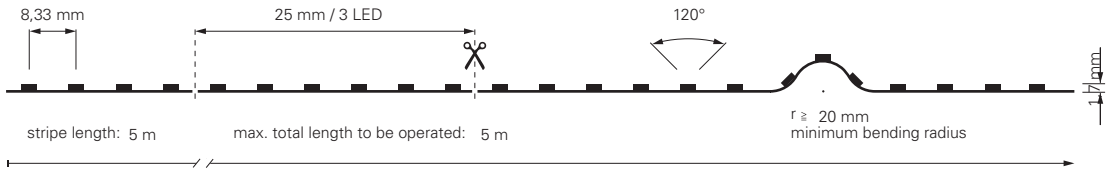

item	colour temperature	efficiency	light current	dimensions L	power	light source	EEL	price
840164	ww 2700K	81 lm/W	570 lm/m	5000 mm	7,0 W/m	120 LED/m	G	89,95 €
840165	ww 3000K	85 lm/W	555 lm/m	5000 mm	6,5 W/m	120 LED/m	F	89,95 €
840166	nw 4000K	96 lm/W	670 lm/m	5000 mm	7,0 W/m	120 LED/m	F	89,95 €
840167	cw 6500K	90 lm/W	630 lm/m	5000 mm	7,0 W/m	120 LED/m	F	89,95 €



3528-120-12V-2700K-5M-SILIKON

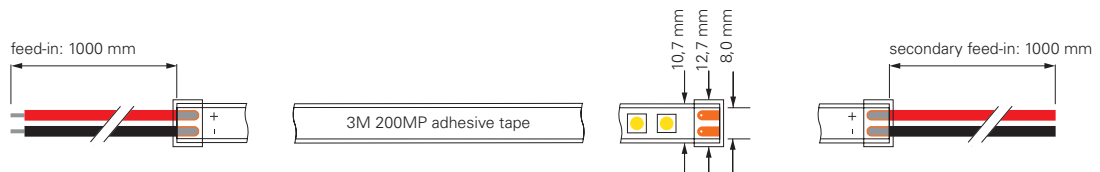
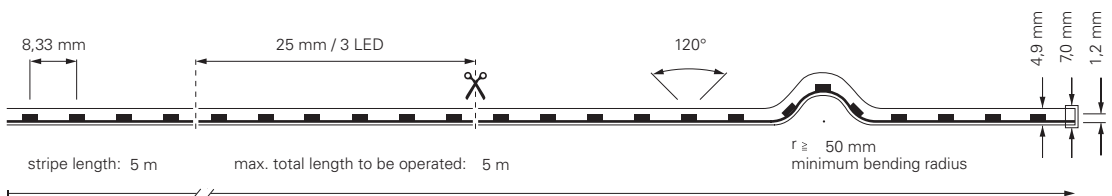

item	colour temperature	efficiency	light current	dimensions L	power	light source	price
840172	ww 2700K	79 lm/W	550 lm/m	5000 mm	7 W/m	120 LED/m	139,95 €



incl. accessories: 10x retaining bracket, 20x stainless steel screw, 2x endcap

STANDARD | 1CH | 24V

LED stripes in warm white 2700K + 3000K, neutral white 4000K and cold white 6500K
These LED stripes are ideally suited for all standard applications and special assemblies with the most diverse requirements. With voltages of 24V, different protection classes, lumens, number of LEDs, power and much more, you will find the right LED stripe for your application.





3528-120-24V-2700K / 3000K-5M

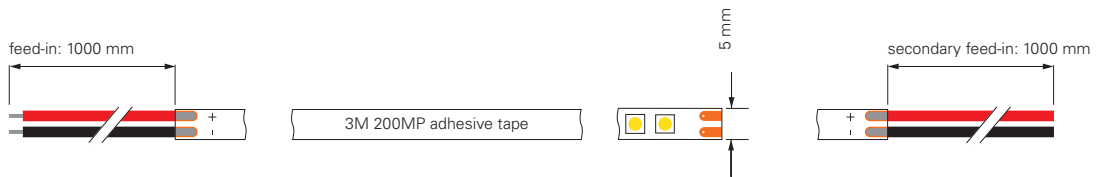
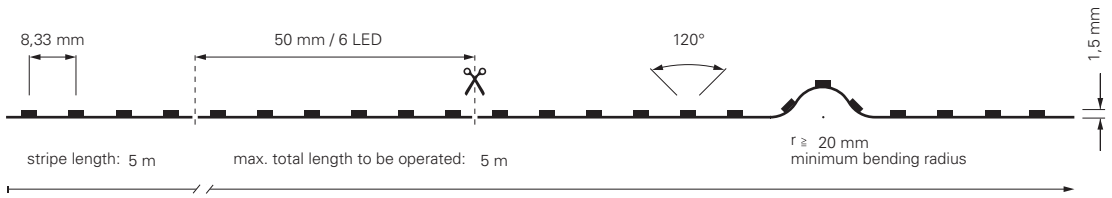

item	colour temperature	efficiency	light current	dimensions L	power	light source	price
840158	ww 2700K	80 lm/W	680 lm/m	5000 mm	8,5 W/m	120 LED/m	79,95 €
840159	ww 3000K	70 lm/W	730 lm/m	5000 mm	10,5 W/m	120 LED/m	79,95 €



2835-120-24V-3000K-10M

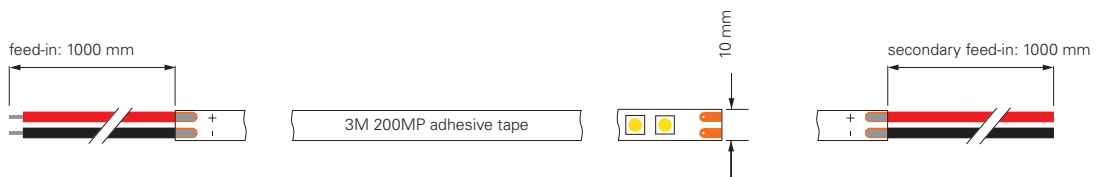
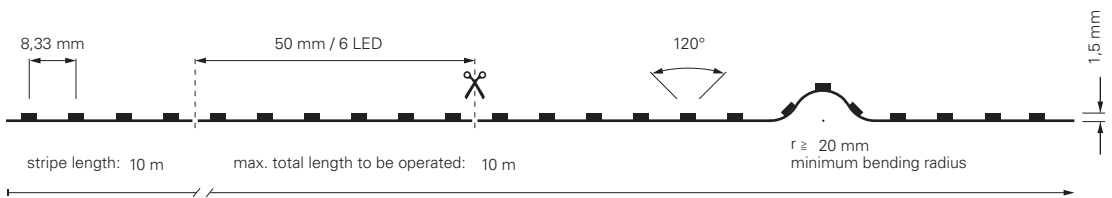

item	colour temperature	efficiency	light current	dimensions L	power	light source	price
840291	ww 3000K	74 lm/W	705 lm/m	10000 mm	9,5 W/m	120 LED/m	399,95 €





2216-266-24V-2700K / 3000K / 4000K-5M

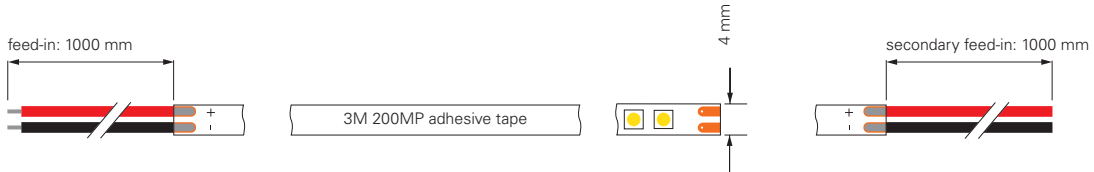
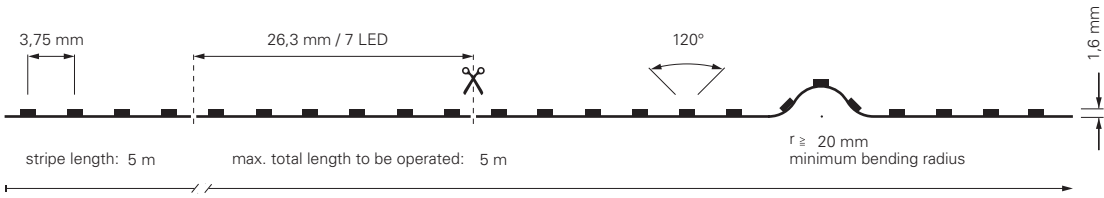

item	colour	temperature	efficiency	light current	dimensions L	power	light source	price
840175	ww	2700K	90 lm/W	995 lm/m	5000 mm	11,0 W/m	266 LED/m	169,95 €
840210	ww	3000K	99 lm/W	1090 lm/m	5000 mm	11,0 W/m	266 LED/m	169,95 €
840267	nw	4000K	96 lm/W	1100 lm/m	5000 mm	11,5 W/m	266 LED/m	169,95 €

CV 24 Volt SMD 2216 Ra 90 1 CH IP20 -15°C +50°C A ↑ G F

3528-180-24V-2700K-5M / 3000K-5M / 3000K-50M / 4000K-5M / 4000K-50M

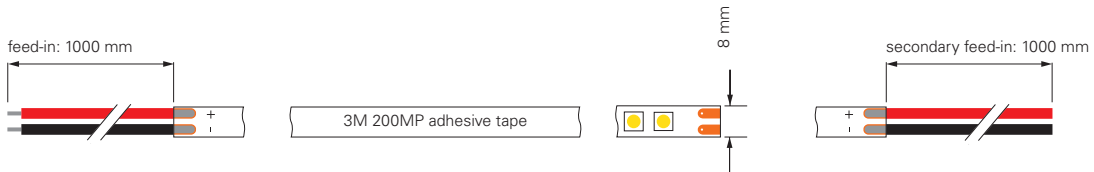
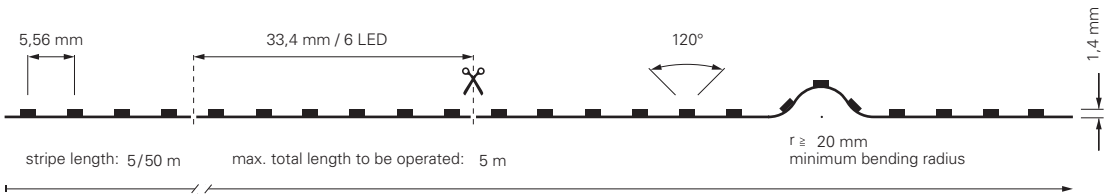

item	colour	temperature	efficiency	light current	dimensions L	power	light source	EEL	price
840178	ww	2700K	79 lm/W	1110 lm/m	5000 mm	14,0 W/m	180 LED/m	G	124,95 €
840179	ww	3000K	81 lm/W	1100 lm/m	5000 mm	13,5 W/m	180 LED/m	G	124,95 €
930512	ww	3000K	81 lm/W	1100 lm/m	50000 mm	13,5 W/m	180 LED/m	G	1.169,95 €
840180	nw	4000K	90 lm/W	1220 lm/m	5000 mm	13,5 W/m	180 LED/m	F	124,95 €
930513	nw	4000K	91 lm/W	1225 lm/m	50000 mm	13,5 W/m	180 LED/m	F	1.169,95 €

CV 24 Volt SMD 3528 Ra 90 1 CH IP20 -15°C +50°C A ↑ G F

3528-240-24V-2700K-5M / 3000K-5M / 3000K-50M / 4000K-5M / 4000K-50M

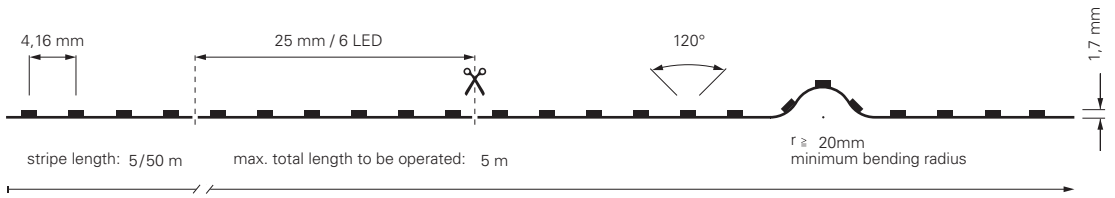

item	colour temperature	efficiency	light current	dimensions L	power	light source	EEL	price
840192	ww 2700K	66 lm/W	1215 lm/m	5000 mm	18,5 W/m	240 LED/m	G	164,95 €
840193	ww 3000K	84 lm/W	1605 lm/m	5000 mm	19,0 W/m	240 LED/m	G	164,95 €
930514	ww 3000K	84 lm/W	1605 lm/m	50000 mm	19,0 W/m	240 LED/m	G	1.469,95 €
840194	nw 4000K	89 lm/W	1770 lm/m	5000 mm	20,0 W/m	240 LED/m	F	164,95 €
930515	nw 4000K	89 lm/W	1770 lm/m	50000 mm	20,0 W/m	240 LED/m	F	1.469,95 €

CV

24 Volt

SMD 3528

Ra 90

+

-

1 CH

IP20

-15°C
+50°C

A
↑
G

F



2835-120-24V-3000K / 6000K-5M

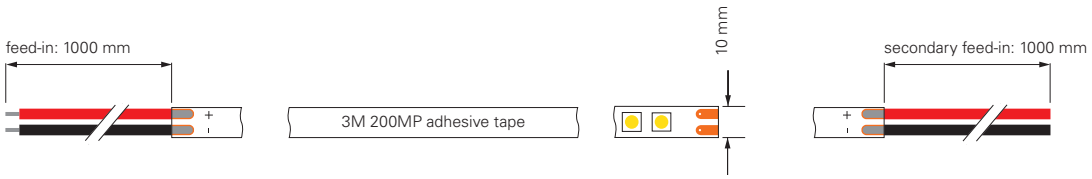
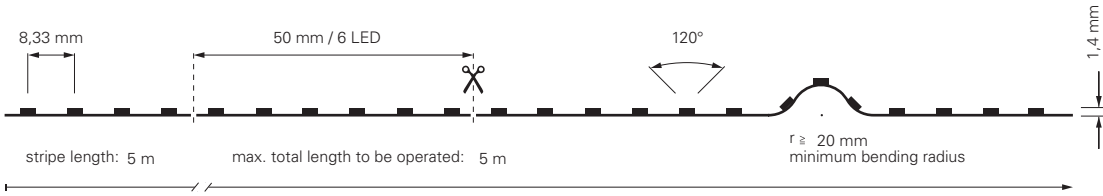

item	colour temperature	efficiency	light current	dimensions L	power	light source	price
840122	ww 3000K	76 lm/W	1595 lm/m	5000 mm	21 W/m	120 LED/m	194,95 €
840124	cw 6000K	86 lm/W	1720 lm/m	5000 mm	20 W/m	120 LED/m	194,95 €

CV 24 Volt SMD 2835 Ra 95 1 CH IP20 -15°C +50°C A ↑ G **G**



2835-160-24V-3000K / 4000K-5M

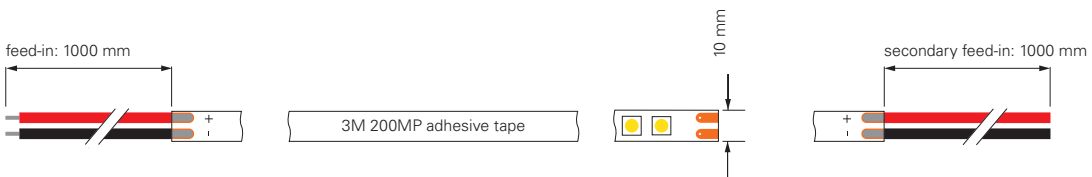
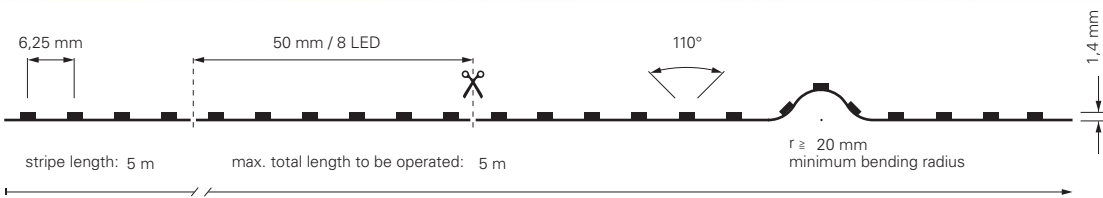

item	colour temperature	efficiency	light current	dimensions L	power	light source	EEL	price
840331	ww 3000K	114 lm/W	2570 lm/m	5000 mm	22,5 W/m	160 LED/m	E	249,95 €
840332	ww 4000K	125 lm/W	2815 lm/m	5000 mm	22,5 W/m	160 LED/m	D	249,95 €

CV 24 Volt SMD 2835 Ra 90 1 CH IP20 -15°C +50°C A ↑ G **D**



2835-160-24V-3000K / 4000K-5M-SILIKON

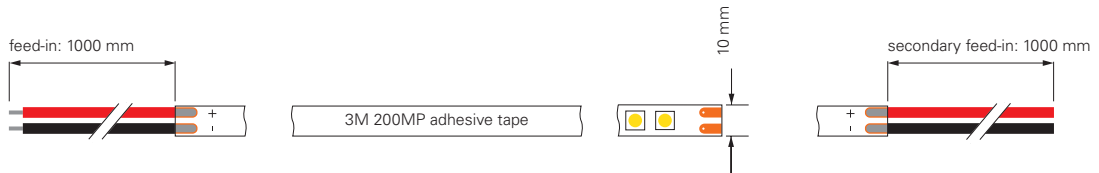
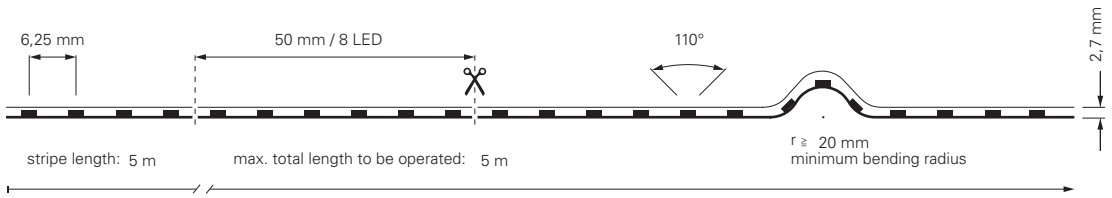

item	colour temperature	efficiency	light current	dimensions L	power	light source	EEL	price
840333	WW 3000K	112 lm/W	2520 lm/m	5000 mm	22,5 W/m	160 LED/m	E	259,95 €
840334	WW 4000K	114 lm/W	2555 lm/m	5000 mm	22,5 W/m	160 LED/m	D	259,95 €



3528-180-24V-2700K / 3000K-5M-SILIKON

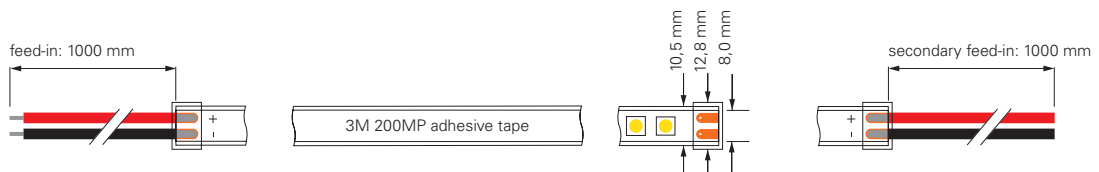
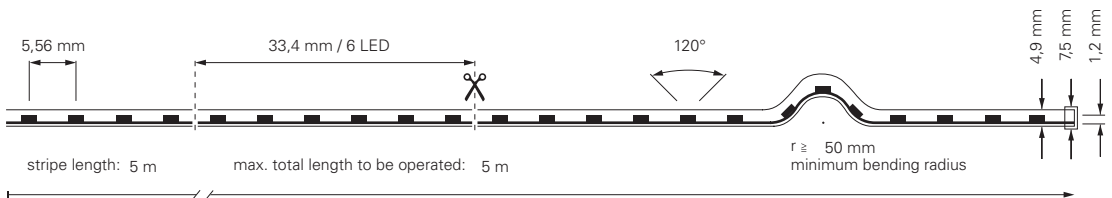

item	colour temperature	efficiency	light current	dimensions L	power	light source	price
840186	WW 2700K	78 lm/W	900 lm/m	5000 mm	11,5 W/m	180 LED/m	184,95 €
840187	WW 3000K	85 lm/W	930 lm/m	5000 mm	11,0 W/m	180 LED/m	184,95 €



incl. accessories: 10x retaining bracket, 20x stainless steel screw, 2x endcap

STANDARD | 1CH | 48V

48V LED Strips in Warm White 3000K, Neutral White 4000K
Our new LED stripes in 48V technology offer users numerous advantages. The key advantage: Compared to 12V and 24V stripes, 48V stripes allow for longer run lengths. By comparison, conventional LED stripes with lower output voltages require a new feed for continuous operation after only 2.5 metres [single-sided feed] or 5 metres [double-sided feed]. LED stripes with 48V can be operated up to a length of 25 metres [single-sided feed] or 50 metres [double-sided feed] - perfect for light coves, on long corridors as well as for simplified integration into existing installations that only allow single-sided feed.

Advantages of 48V LED stripes

- 48V = lower current
- 48V = longer run length
- 48V = thinner wire cross-sections
- 48V = faster installation
- 48V = more versatile applications
- 48V = lower brightness drop

In addition to the advantages mentioned above, our new 48V LED stripes have a very long service life of up to 75,000h for L70B50 and 50,000h for L80B10. Thanks to Reel to Reel production the 48V LED stripes have no soldered joints. Since we have set ourselves the goal to become climate-neutral, the LED stripes are packaged in an environmentally-friendly paper-based packaging.

In addition to the new 48V LED stripes, we of course also offer accessories in the form of power supply units and controllers for the relevant control protocols [RF, DALI, KNX etc.] in order to cover all potential future applications for 48V stripes.



2835-78-48V-3000K-15M / 3000K-50M / 4000K-15M / 4000K-50M

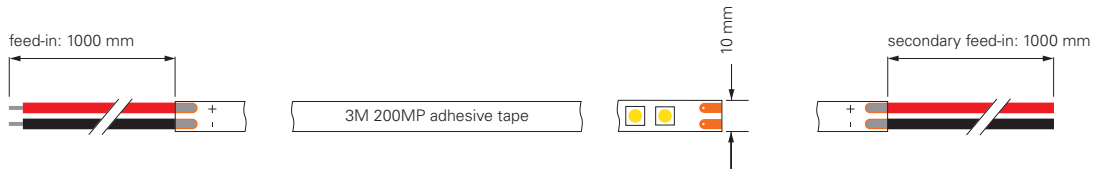
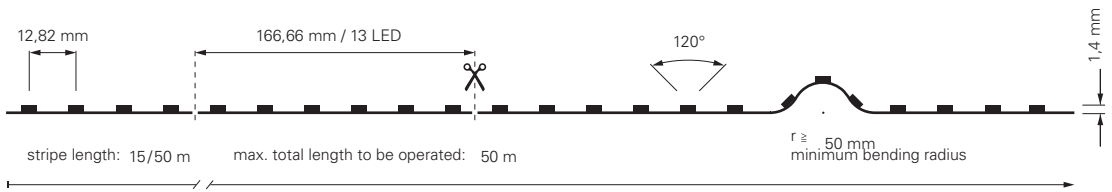

item	colour temperature	efficiency	light current	dimensions L	power	light source	price
840318	ww 3000K	121 lm/W	485 lm/m	15000 mm	4 W/m	78 LED/m	289,95 €
840337	ww 3000K	121 lm/W	485 lm/m	50000 mm	4 W/m	78 LED/m	999,95 €
840320	nw 4000K	133 lm/W	530 lm/m	15000 mm	4 W/m	78 LED/m	289,95 €
840339	nw 4000K	133 lm/W	530 lm/m	50000 mm	4 W/m	78 LED/m	999,95 €



2835-78-48V-3000K-15M / 3000K-50M / 4000K-15M / 4000K-50M-SILIKON

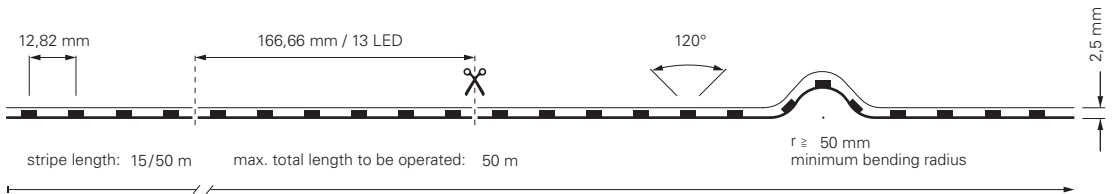

item	colour temperature	efficiency	light current	dimensions L	power	light source	price
840317	ww 3000K	100 lm/W	400 lm/m	15000 mm	4 W/m	78 LED/m	349,95 €
840338	ww 3000K	100 lm/W	400 lm/m	50000 mm	4 W/m	78 LED/m	1.124,95 €
840319	nw 4000K	114 lm/W	455 lm/m	15000 mm	4 W/m	78 LED/m	349,95 €
840340	nw 4000K	114 lm/W	455 lm/m	50000 mm	4 W/m	78 LED/m	1.124,95 €





2835-140-48V-2700K/3000K/4000K

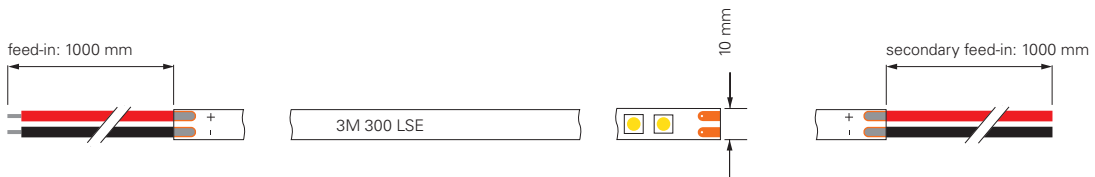
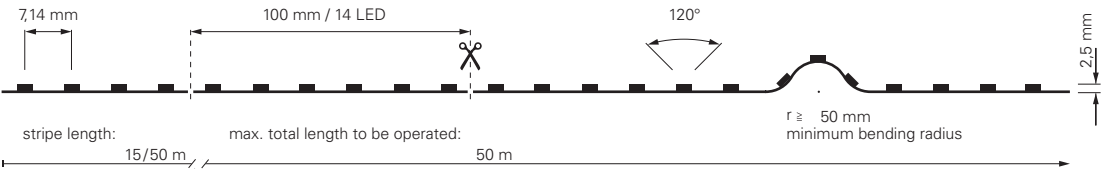

item	colour	temperature	efficiency	light current	dimensions L	power	light source	EEL	price
840393	ww	2700K	121 lm/W	1210 lm/m	15000 mm	10 W/m	140 LED/m	D	399,95 €
840401	ww	2700K	121 lm/W	1210 lm/m	50000 mm	10 W/m	140 LED/m	D	1.299,95 €
840394	ww	3000K	124 lm/W	1240 lm/m	15000 mm	10 W/m	140 LED/m	F	399,95 €
840402	ww	3000K	124 lm/W	1240 lm/m	50000 mm	10 W/m	140 LED/m	F	1.299,95 €
840395	nw	4000K	130 lm/W	1300 lm/m	15000 mm	10 W/m	140 LED/m	E	399,95 €
840403	nw	4000K	130 lm/W	1300 lm/m	50000 mm	10 W/m	140 LED/m	E	1.299,95 €



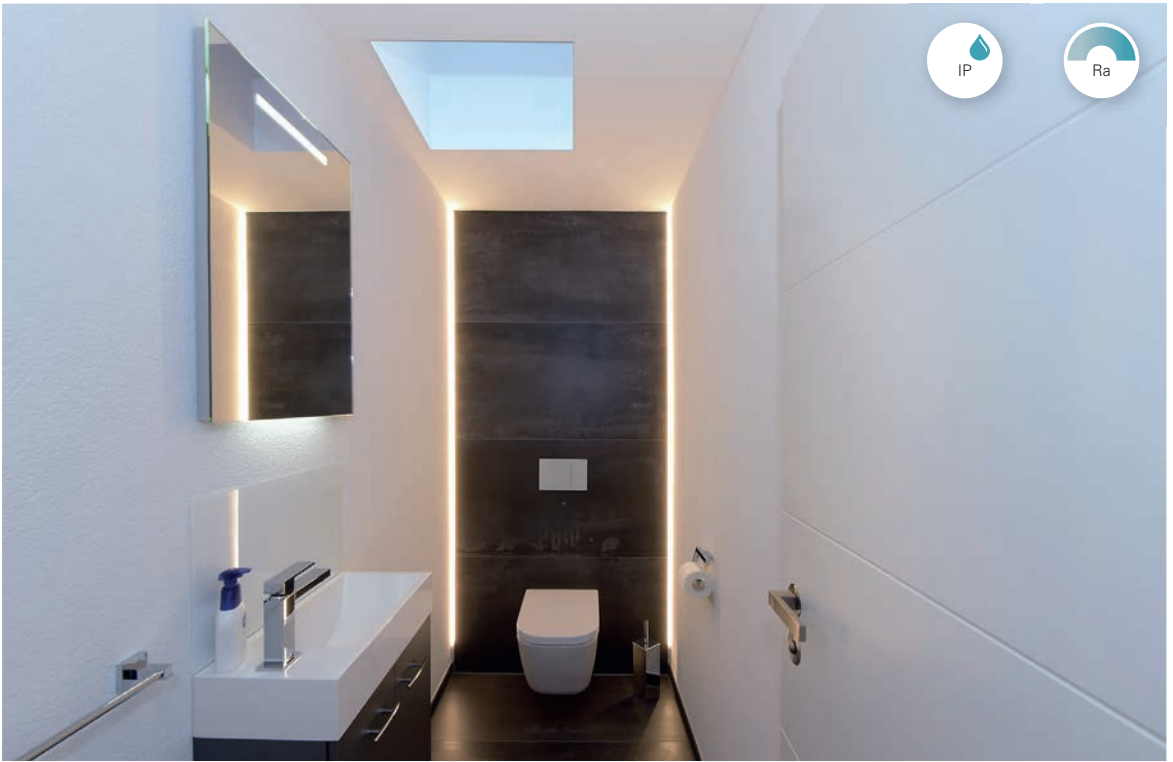

2835-140-48V-2700K/3000K/4000K-SILIKON

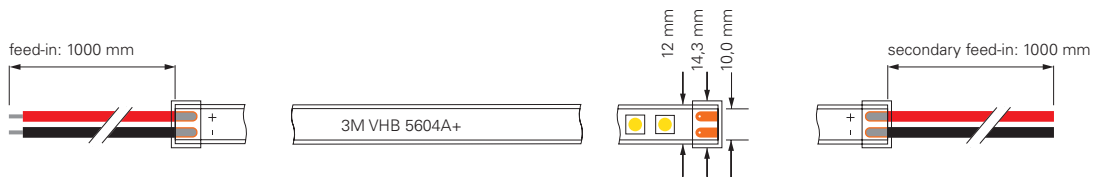
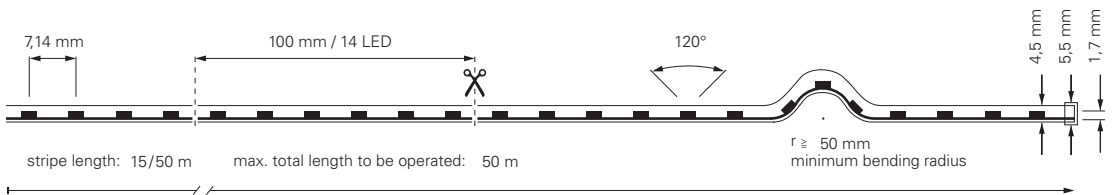

item	colour temperature	efficiency	light current	dimensions L	power	light source	EEL	price
840396	ww 2700K	109 lm/W	1090 lm/m	15000 mm	10 W/m	140 LED/m	D	474,95 €
840404	ww 2700K	109 lm/W	1090 lm/m	50000 mm	10 W/m	140 LED/m	D	1.549,95 €
840397	ww 3000K	112 lm/W	1120 lm/m	15000 mm	10 W/m	140 LED/m	F	474,95 €
840405	ww 3000K	112 lm/W	1120 lm/m	50000 mm	10 W/m	140 LED/m	F	1.549,95 €
840398	nw 4000K	118 lm/W	1180 lm/m	15000 mm	10 W/m	140 LED/m	F	474,95 €
840406	nw 4000K	118 lm/W	1180 lm/m	50000 mm	10 W/m	140 LED/m	F	1.549,95 €



STANDARD | 2CH | 12V

standard stripes in warm white 2700K - cold white 6500K,
warm white 3000K - cold white 6500K
With these standard stripes you have the possibility to mix
white tones between 2700K and 6500K / 3000K and 6500K
through a flexible control.





3528-120-12V-3000K+6500K-5M

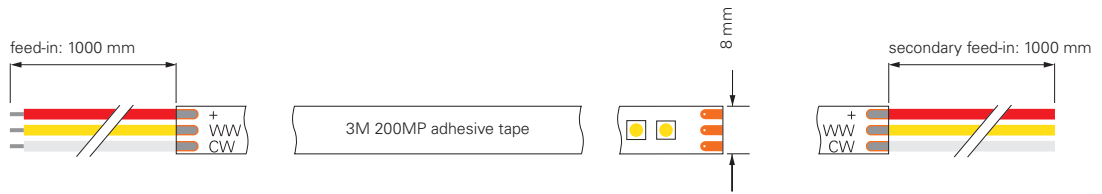
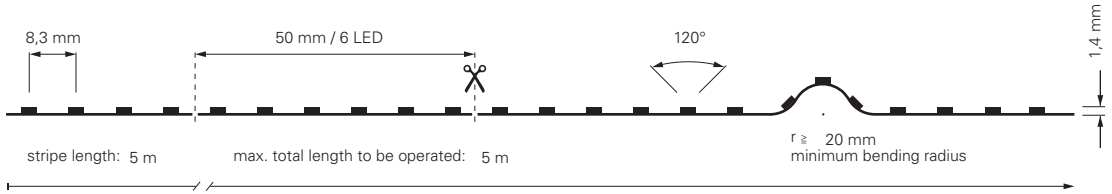

item	colour temperature	efficiency	light current	dimensions L	power	light source	price
840097	ww cw 3000-6500K	76 lm/W	760 lm/m	5000 mm	10 W/m	120 LED/m	124,95 €



3528-120-12V-3000K-6500K-5M

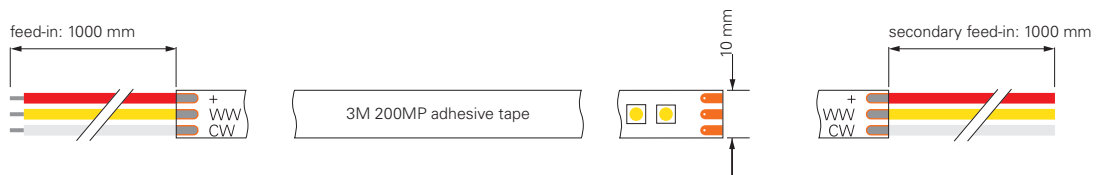
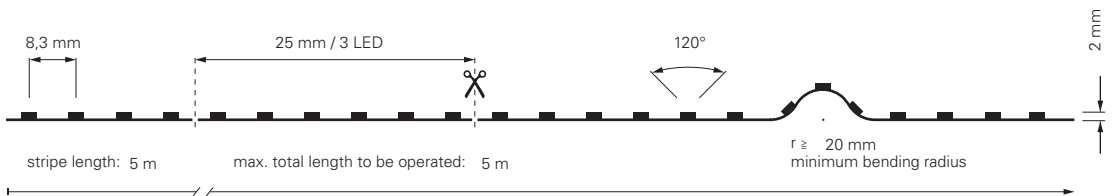

item	colour temperature	efficiency	light current	dimensions L	power	light source	price
840142	ww cw 3000-6500K	98 lm/W	1025 lm/m	5000 mm	10,5 W/m	120 LED/m	199,95 €



STANDARD | 2CH | 24V

standard stripes in warm white 2700K - cold white 6500K,
warm white 3000K - cold white 6500K

These LED stripes are ideally suited for all standard applications and special assemblies with the most diverse requirements. With these standard stripes, you have the option of mixing white tones between 2700K and 6500K /3000K and 6500K through flexible control.





2216-196-24V-3000-6500K-5M

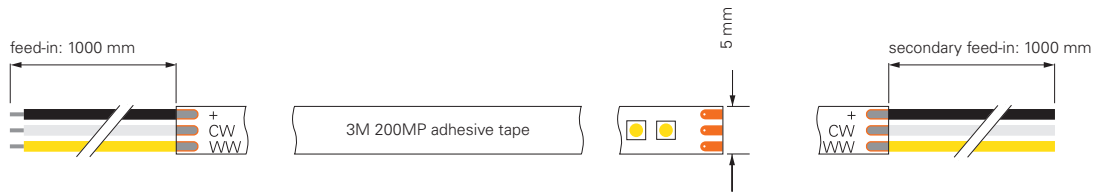
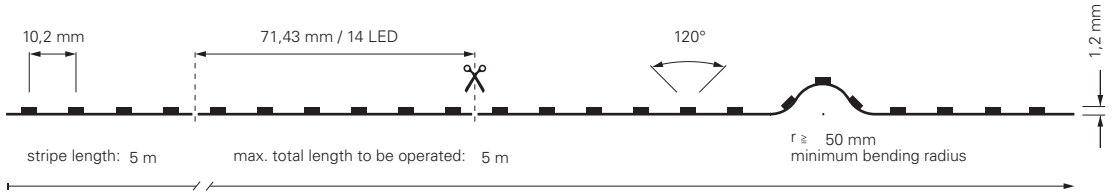

item	colour temperature	efficiency	light current	dimensions L	power	light source	price
840350	WW CW 3000-6500K	93 lm/W	1025 lm/m	5000 mm	11 W/m	196 LED/m	124,95 €



2835-120-24V-2700-6500K-5M

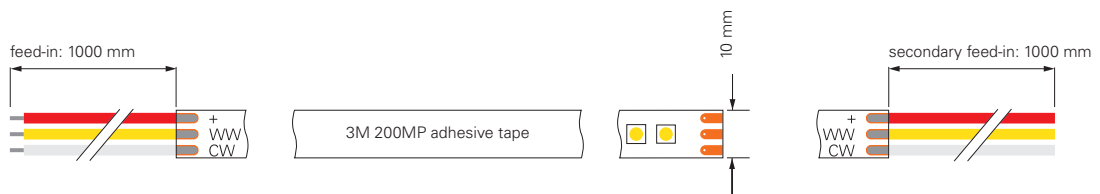
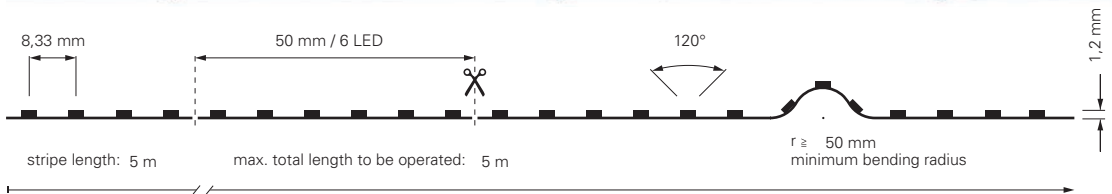

item	colour temperature	efficiency	light current	dimensions L	power	light source	price
840378	WW CW 2700-6500K	103 lm/W	1765 lm/m	5000 mm	17,2 W/m	140 LED/m	199,95 €





2835-120-24V-2700-6500K-5M-SILIKON

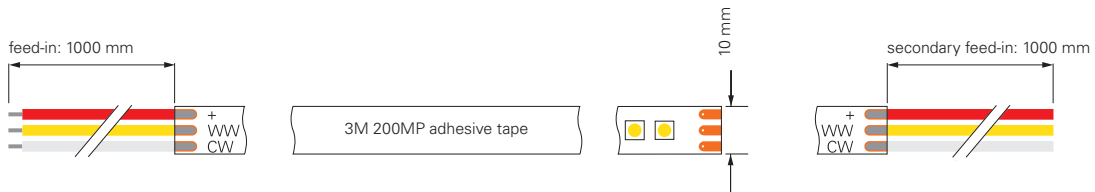
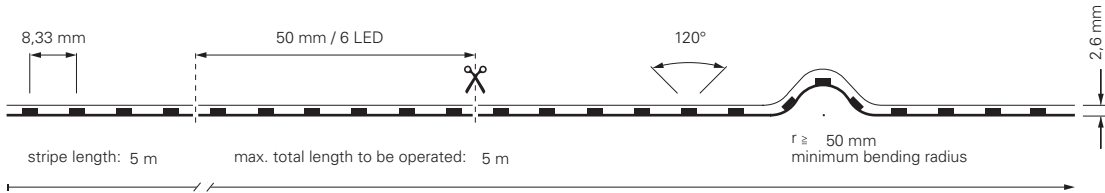

item	colour	temperature	efficiency	light current	dimensions L	power	light source	price	
840379	WW	CW	2700-6500K	105 lm/W	1470 lm/m	5000 mm	14 W/m	140 LED/m	219,95 €



2216-196-24V-3000-6500K-5M-SILIKON

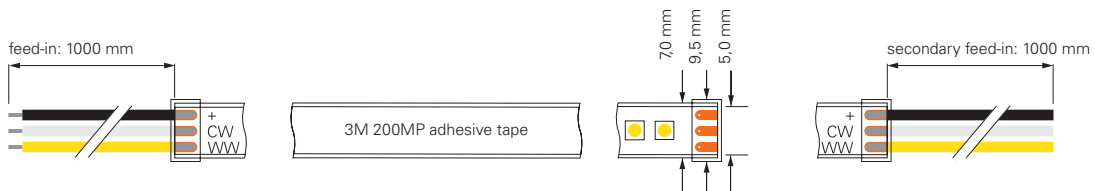
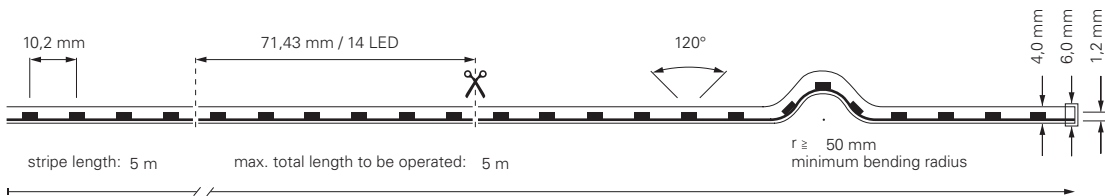

item	colour	temperature	efficiency	light current	dimensions L	power	light source	price	
840349	WW	CW	3000-6500K	86 lm/W	1070 lm/m	5000 mm	12,5 W/m	196 LED/m	149,95 €



incl. accessories: 10x retaining bracket, 20x stainless steel screw, 2x endcap



STANDARD | 3CH | 24V

These LED stripes in RGB are ideally suited for all standard applications and special assemblies with the most diverse requirements. With these standard stripes, you have the option of setting individual colours or flexible control to set individual colours or mixed colours as desired.





3535-120-24V-RGB-5M

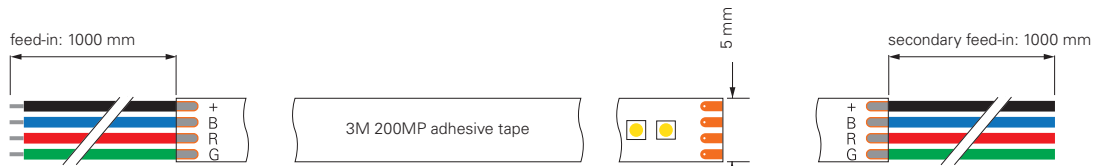
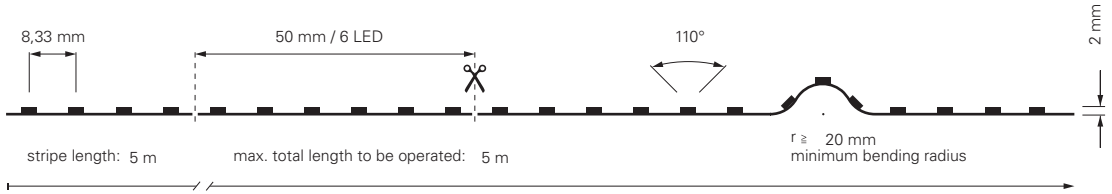

item	colour temperature	efficiency	light current	dimensions L	power	light source	price
840276	RGB 470-630 nm	45 lm/W	500 lm/m	5000 mm	11 W/m	120 LED/m	109,95 €



5050-60-24V-RGB-5M

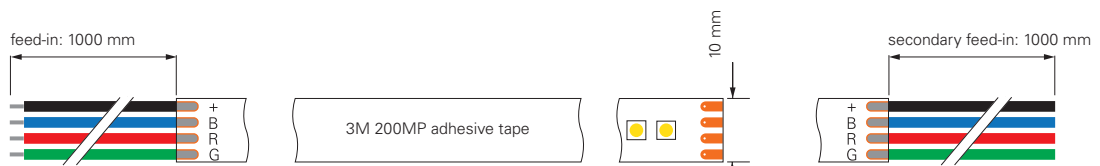
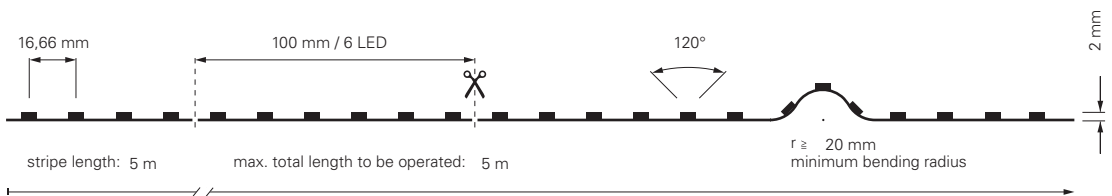

item	colour temperature	efficiency	light current	dimensions L	power	light source	price
840254	RGB 470-630 nm	45 lm/W	580 lm/m	5000 mm	13 W/m	60 LED/m	134,95 €





5050-96-24V-RGB-5M / RGB-50M

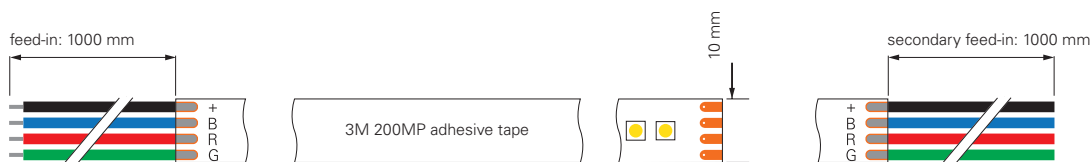
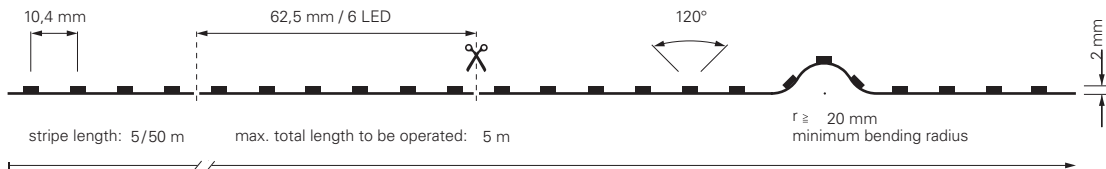

item	colour temperature	efficiency	light current	dimensions L	power	light source	price
840147	450-630 nm	48 lm/W	665 lm/m	5000 mm	14,0 W/m	96 LED/m	169,95 €
930516	450-630 nm	46 lm/W	665 lm/m	50000 mm	14,5 W/m	96 LED/m	1.574,95 €



5050-120-24V-RGB-5M

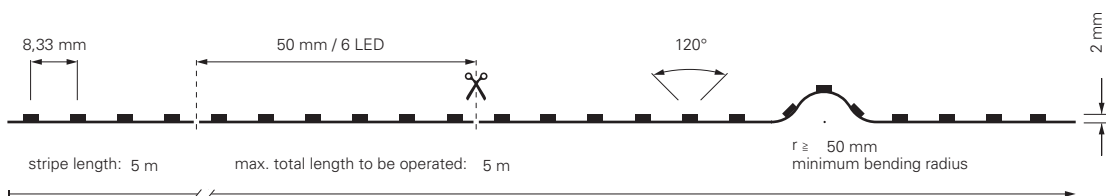

item	colour temperature	efficiency	light current	dimensions L	power	light source	price
840352	460-620 nm	38 lm/W	1055 lm/m	5000 mm	28 W/m	120 LED/m	209,95 €





5050-120-24V-RGB-5M-SILIKON

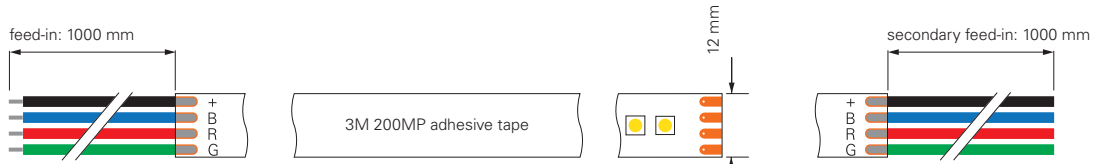
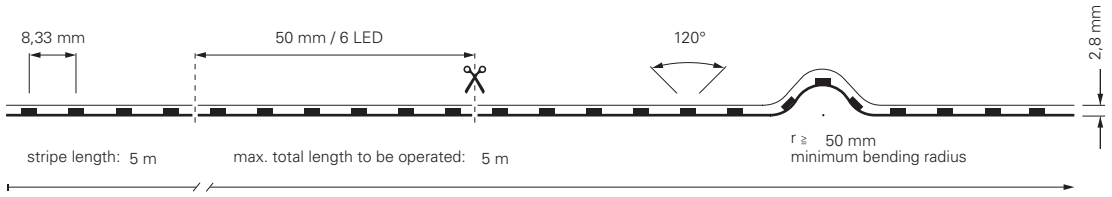

item	colour temperature	efficiency	light current	dimensions L	power	light source	price
840351	RGB 460-620 nm	38 lm/W	1045 lm/m	5000 mm	27,5 W/m	120 LED/m	214,95 €



5050-60-24V-RGB-5M-SILIKON

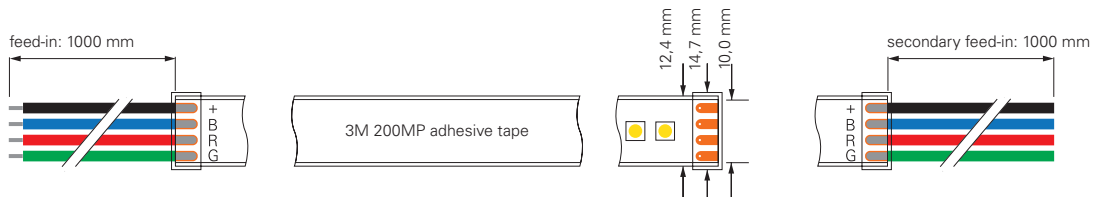
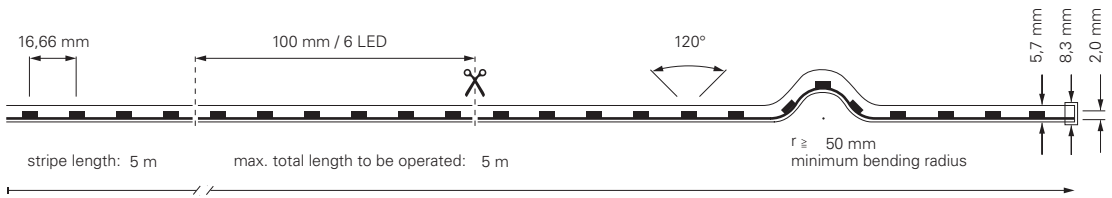

item	colour temperature	efficiency	light current	dimensions L	power	light source	price
840256	RGB 470-630 nm	42 lm/W	530 lm/m	5000 mm	12,5 W/m	60 LED/m	159,95 €



incl. accessories: 10x retaining bracket, 20x stainless steel screw, 2x endcap

STANDARD | 3CH | 48V

Our new LED stripes in 48V technology offer users numerous advantages. The key advantage: Compared to 12V and 24V stripes, 48V stripes allow longer running lengths. By comparison, conventional LED stripes with lower output voltage require a new feed after only 2.5 metres [single-sided feed] or 5 metres [feed from both sides], for continuous operation. LED stripes with 48V can be used up to a length of 25 metres [single-sided feed] or feed) or 50 metres [feed on both sides] - perfect for lighting covers, long corridors and simplified integration into existing installations, that only allow a single-sided feed.

Advantages of 48V LED stripes

- 48V = lower current
- 48V = longer running length
- 48V = thinner wire cross-sections
- 48V = faster installation
- 48V = more versatile applications
- 48V = lower brightness drop

In addition to the advantages mentioned above, our new 48V LED stripes have a very long service life of up to 75,000h for L70B50 and 50,000h for L80B10. Thanks to reel-to-reel production, the 48V LED stripes have no soldered joints. As we have set ourselves the goal to become climate-neutral, the LED stripes are packaged in an environmentally friendly paper-based packaging.

In addition to the new 48V LED stripes, we of course also offer accessories in the form of power supply units and controllers for the relevant control protocols [RF, DALI, KNX etc.] in order to cover all potential future applications for 48V stripes.



3535-140-48V-RGB

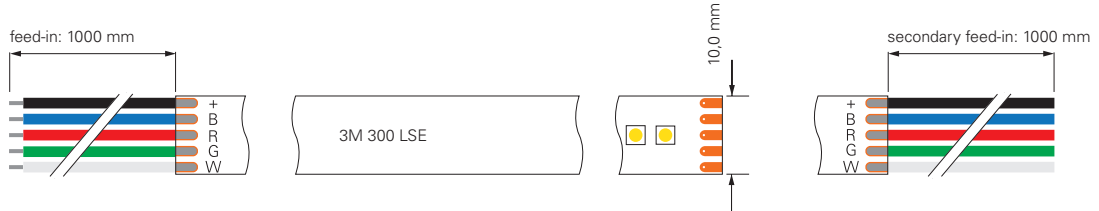
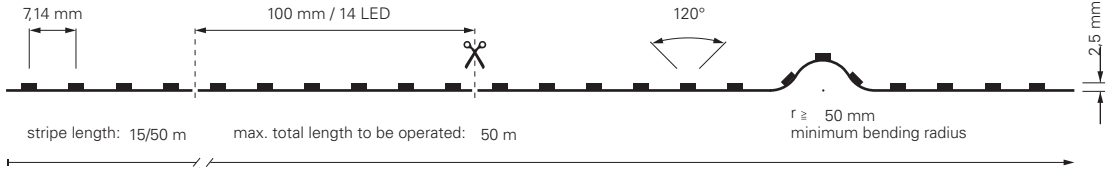

item	colour	temperature	efficiency	light current	dimensions L	power	light source	price
840399	RGB	450-630 nm	51 lm/W	510 lm/m	15000 mm	10 W/m	140 LED/m	449,95 €
840407	RGB	450-630 nm	51 lm/W	510 lm/m	50000 mm	10 W/m	140 LED/m	1.499,95 €

CV 48 Volt SMD 3535 3 CH IP20 -10°C +55°C

3535-140-48V-RGB-SILIKON

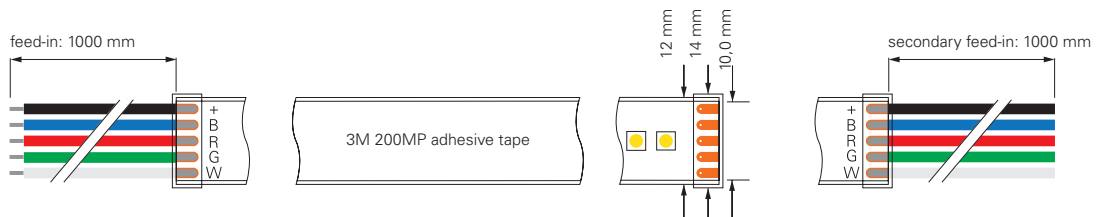
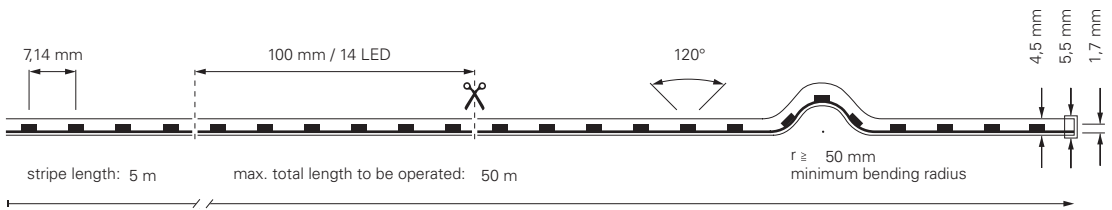

item	colour	temperature	efficiency	light current	dimensions L	power	light source	price
840400	RGB	450-630 nm	45 lm/W	450 lm/m	15000 mm	10 W/m	140 LED/m	524,95 €
840408	RGB	450-630 nm	45 lm/W	450 lm/m	50000 mm	10 W/m	140 LED/m	1.749,95 €

CV 48 Volt SMD 3535 3 CH IP67 -10°C +55°C

STANDARD | 4CH | 24V

LED stripes in RGB + 3000K, 4000K

These LED stripes are ideally suited for all standard applications and special assemblies with the most diverse requirements. With these LED stripes, you have the option of setting single colours, warm white, neutral white, cold white or mixed colours as desired through flexible control.





5050-96-24V-RGB+3000K-5M

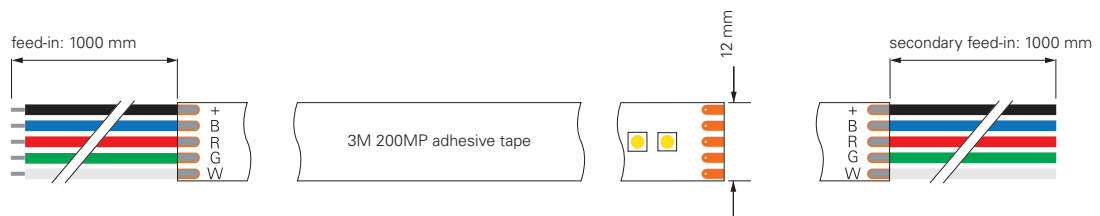
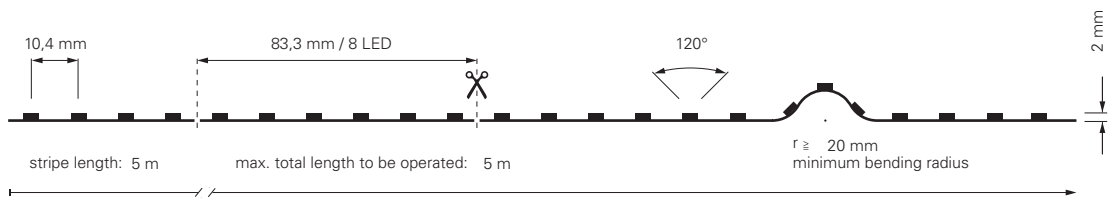

item	colour temperature	efficiency	light current	dimensions L	power	light source	price
840144	RGB WW 450-630 nm + 3000K	42 lm/W	585 lm/m	5000 mm	14W/m	96 LED/m	169,95 €



5050-60-24V-RGB+3000K-5M + 5050-60-24V-RGB+3000K-50M

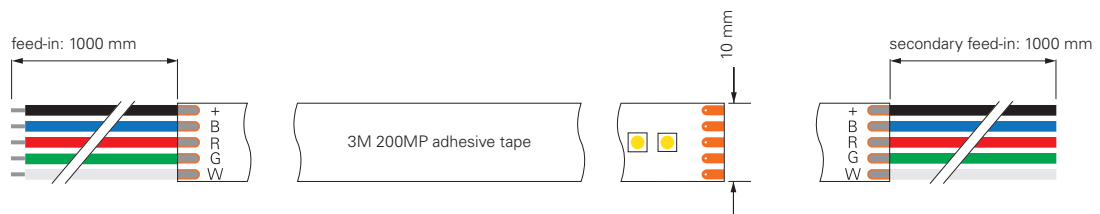
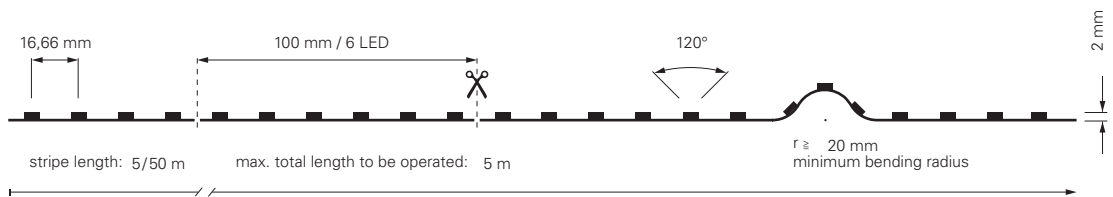

item	colour temperature	efficiency	light current	dimensions L	power	light source	price
840236	RGB WW 450-630 nm + 3000K	51 lm/W	820 lm/m	5000 mm	16 W/m	60 LED/m	144,95 €
930517	RGB WW 450-630 nm + 3000K	51 lm/W	820 lm/m	50000 mm	16 W/m	60 LED/m	1.299,95 €





5050-60-24V-RGB+4000K-5M

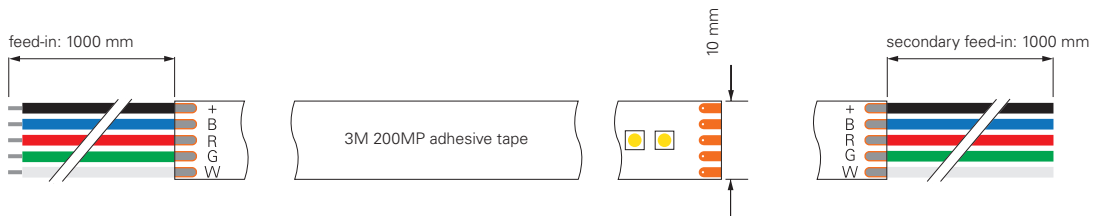
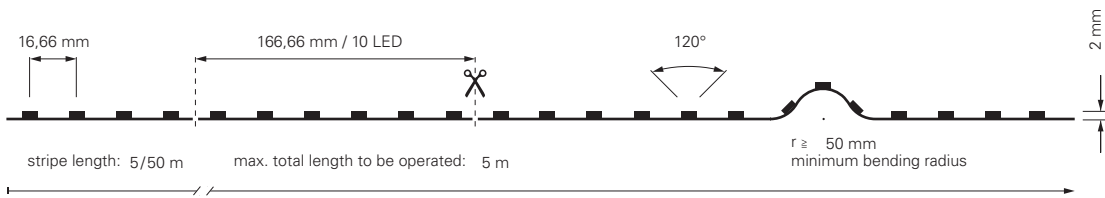

item	colour temperature	efficiency	light current	dimensions L	power	light source	price
840353	RGB NW 450-630 nm + 4000K	47 lm/W	775 lm/m	5000 mm	16,5 W/m	60 LED/m	149,95 €

CV 24 Volt SMD 5050 Ra 80 4 CH IP20 -15°C +50°C A ↑ G G

3535-192-24V-RGB+3000K-5M / RGB+4000K-5M

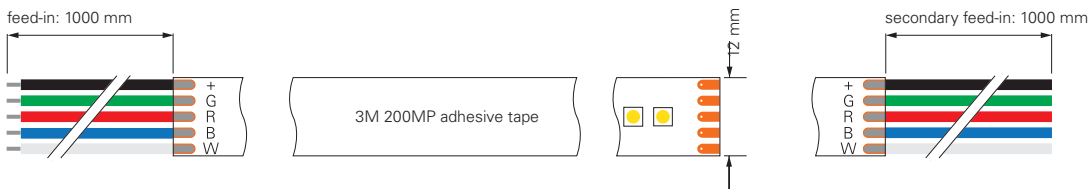
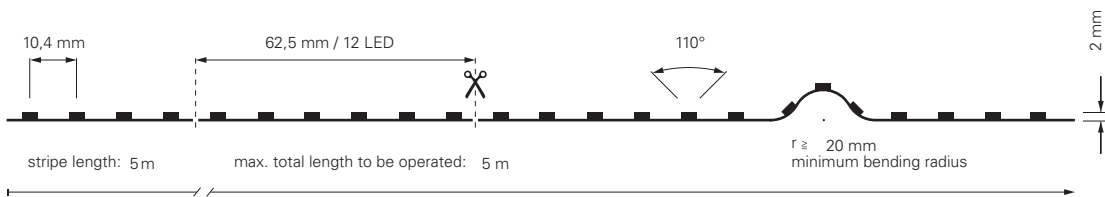

item	colour temperature	efficiency	light current	dimensions L	power	light source	EEL	price
840308	RGB WW 470-630 nm + 3000K	43 lm/W	955 lm/m	5000 mm	22 W/m	192 LED/m	G	179,95 €
840309	RGB NW 470-630 nm + 4000K	45 lm/W	985 lm/m	5000 mm	22 W/m	192 LED/m	E	179,95 €

CV 24 Volt SMD 3535 Ra 90 4 CH IP20 -15°C +50°C A ↑ G E

5050-60-24V-RGB+4000K-5M-SILIKON

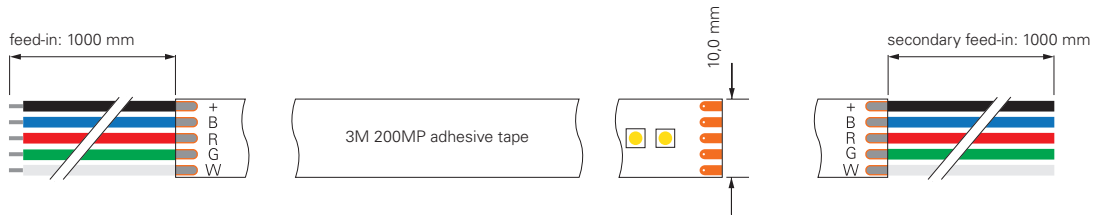
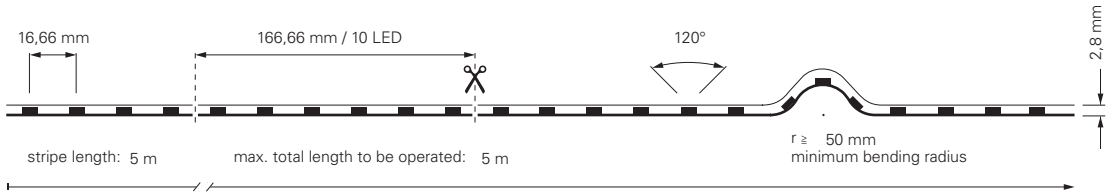

item	colour temperature	efficiency	light current	dimensions L	power	light source	price
840373	RGB NW 450-630 nm + 4000K	48 lm/W	765 lm/m	5000 mm	16,0 W/m	60 LED/m	159,95 €



5050-60-24V-RGB+3000K-5M-SILIKON

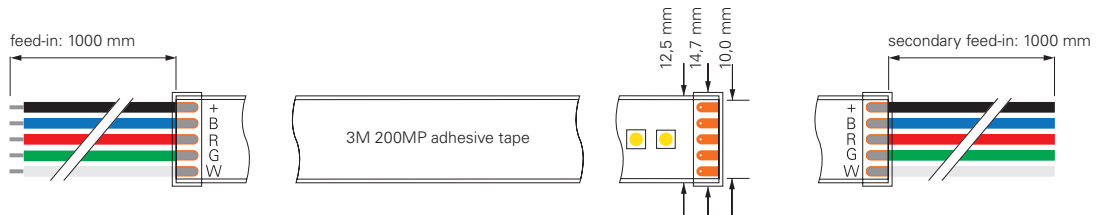
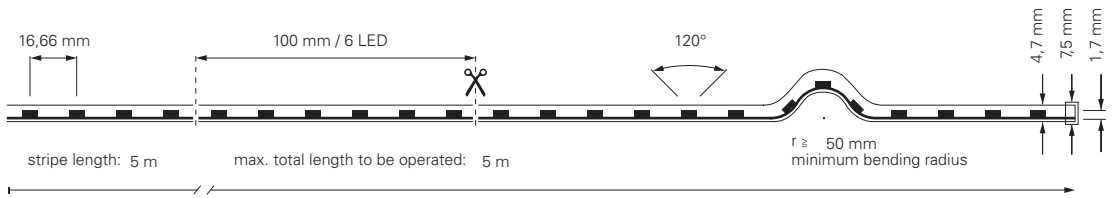

item	colour temperature	efficiency	light current	dimensions L	power	light source	price
840239	RGB WW 450-630 nm + 3000K	49 lm/W	735 lm/m	5000 mm	15 W/m	60 LED/m	174,95 €



incl. accessories: 10x retaining bracket, 20x stainless steel screw, 2x endcap

D FLEX LINE – FLEXIBLE IN MANY WAYS

Are you looking for a flexible, water-protected and homogeneously illuminated LED stripe? With our D FLEX LINE series, we combine all requirements in one continuous row. Our D Flex Line stripes are available in two basic versions, as top view and side view. The difference lies in the built-in positioning of the LED stripes, because this results in two significant differences in the possible mounting / placement of the stripes.

Due to a completely flexible potting, the D FLEX LINE achieve a degree of protection of up to IP68 as well as a completely homogeneous light pattern in the different LED stripes versions warm white, RGB and RGB + warm white due to the respective placement of the LED stripe. The shape and encapsulation also have a significant influence on the radiation behaviour of our stripes, allowing you to achieve a beam angle of up to 180°.

The maximum total length to be operated is 5m. You can shorten the continuous rooflights at the and marked points. Each D Flex Line stripe is supplied with a feed and secondary feed of 3m each. This ensures a flexible, convenient and simple installation is guaranteed. The feed is supplied with tinned wire ends. In addition, our D FLEX LINE tapes are flame retardant and resistant to UV, chlorinated water, alt water and commercial cleaners [note content concentrations, not sea water resistant].



TOP VIEW

The LED stripe is arranged / installed horizontally, which means that the flex stripe can be bent up and down. [note the respective minimum bending radius]



D FLEX LINE TOP VIEW IP68 3000K

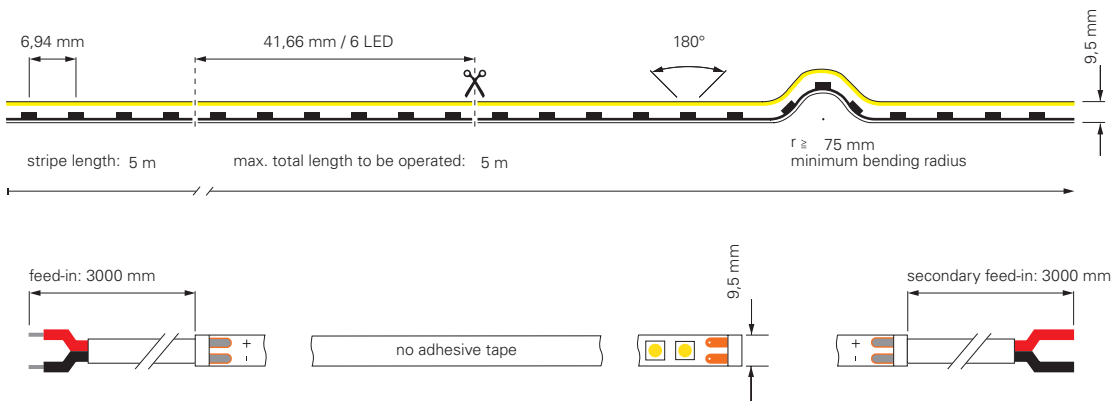

item	colour temperature	efficiency	light current	dimensions L	power	light source	price
840285	3000K	70 lm/W	730 lm/m	5000 mm	10,5 W/m	144 LED/m	479,95 €



incl. accessories: 10x retaining clip, 10x screw, 2x endcap

930446	profile for D Flex Line MINI aluminium anodized L x W x H: 1000 x 12 x 13 mm	14,94 €
930445	profile for D Flex Line MINI plastic transparent L x W x H: 1000 x 12 x 13 mm	10,95 €
930531	assembly set for D Flex Line 10 x 10 mm	10,95 €
930593	gel glue for gluing the end caps 3g	5,95 €



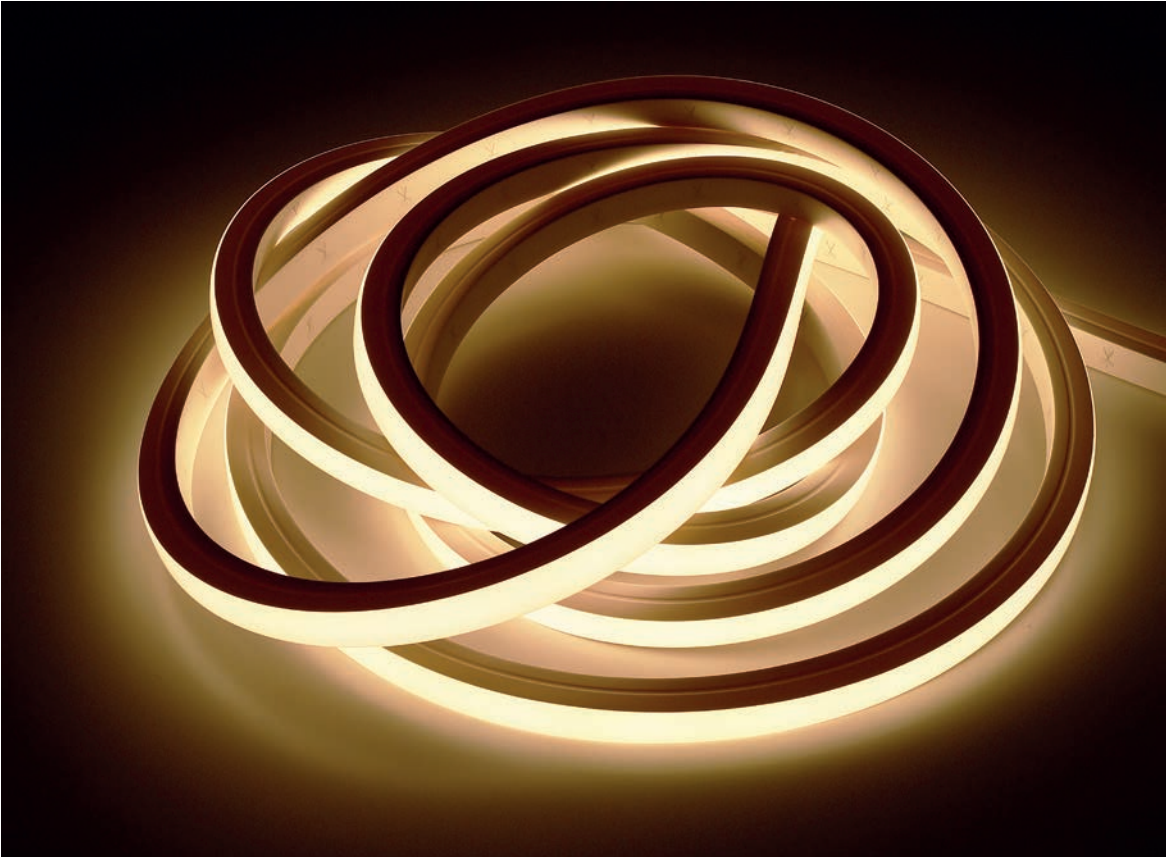

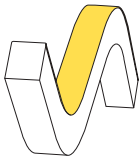

D FLEX LINE MINITOP VIEW IP68 3000K

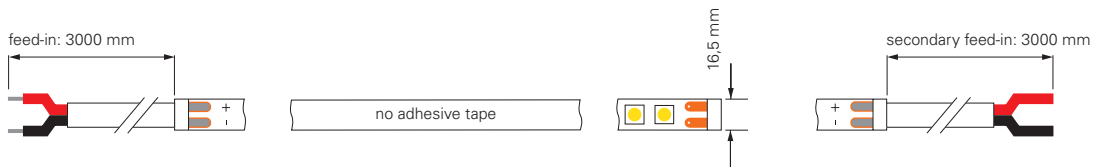
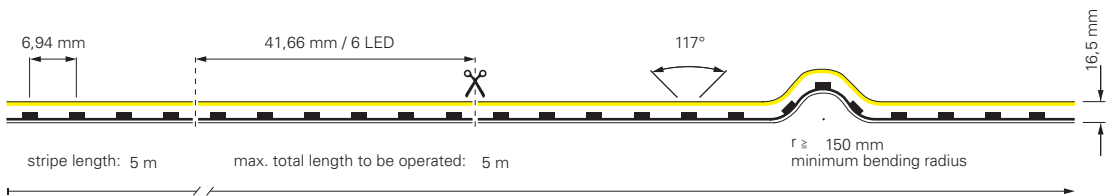

item	colour	temperature	efficiency	light current	dimensions L	power	light source	price
840288	ww	3000K	49 lm/W	515 lm/m	5000 mm	10,5 W/m	144 LED/m	749,95 €



incl. accessories: 10x retaining clip, 10x screw, 2x endcap

- 930448** profile for D Flex Line TOP aluminium anodized L x W x H: 1000 x 19 x 18 mm **14,94 €**
- 930449** profile for D Flex Line TOP plastic | transparent L x W x H: 1000 x 19 x 18 mm **11,95 €**
- 930533** assembly set for D Flex Line | 16 x 15 mm **10,95 €**
- 930593** gel glue for gluing the end caps 3g **5,95 €**



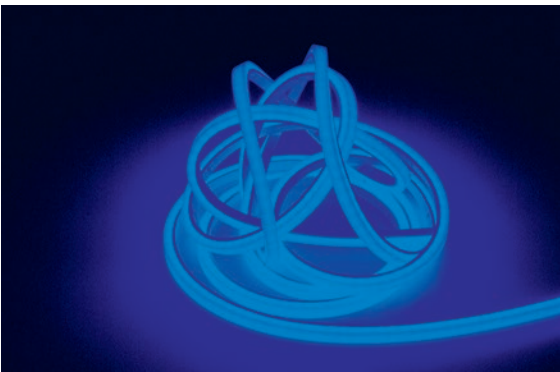
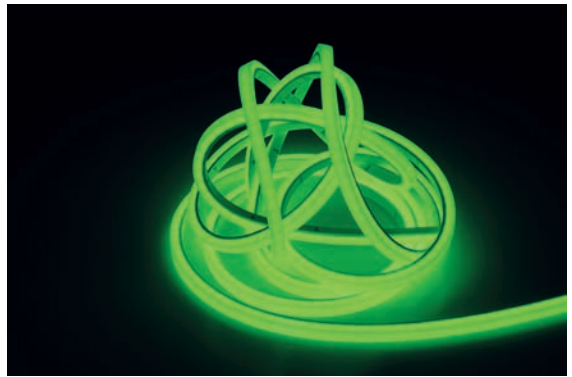
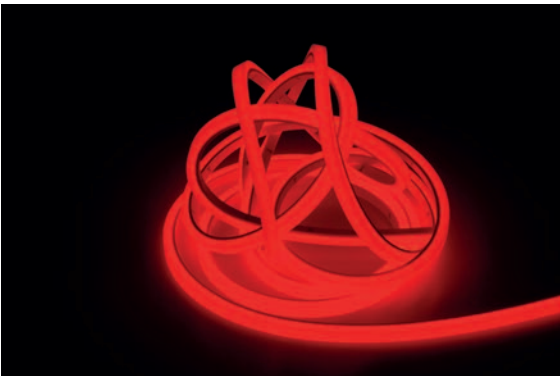
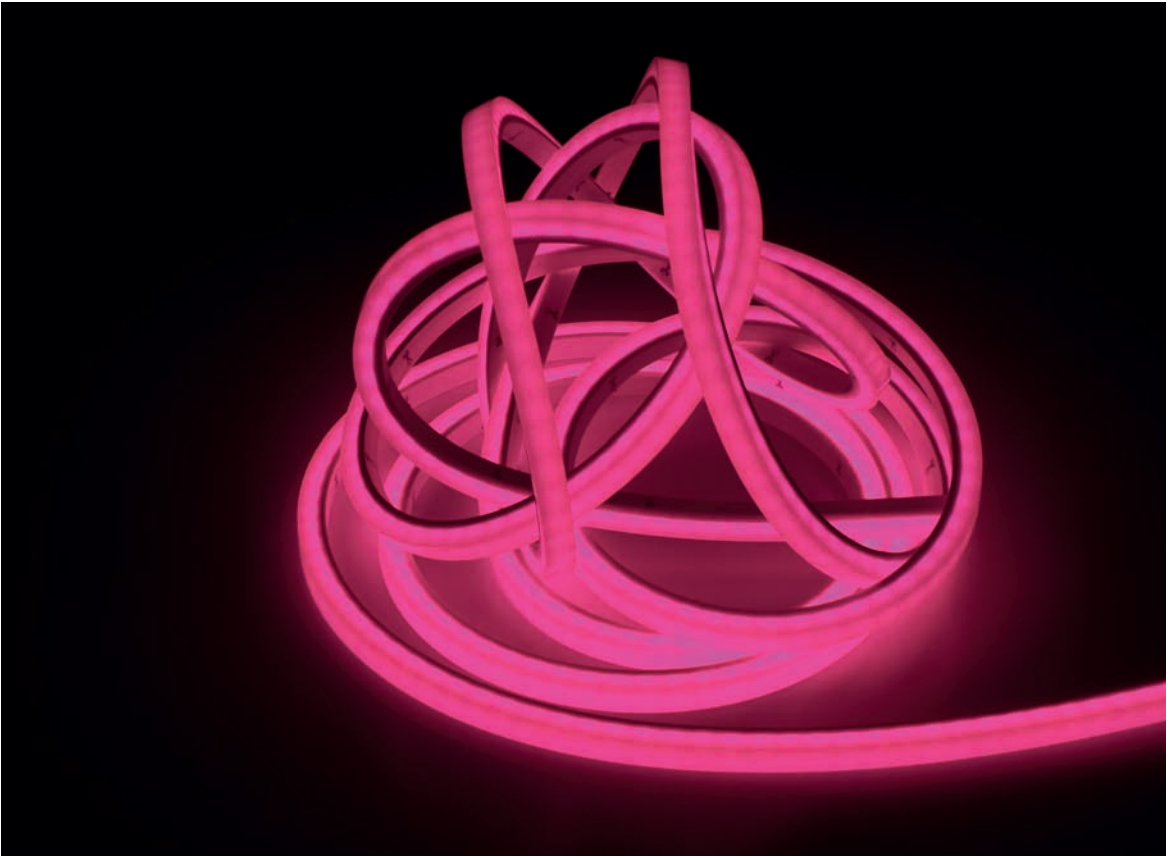

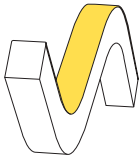

D FLEX LINE TOP VIEW IP68 RGB

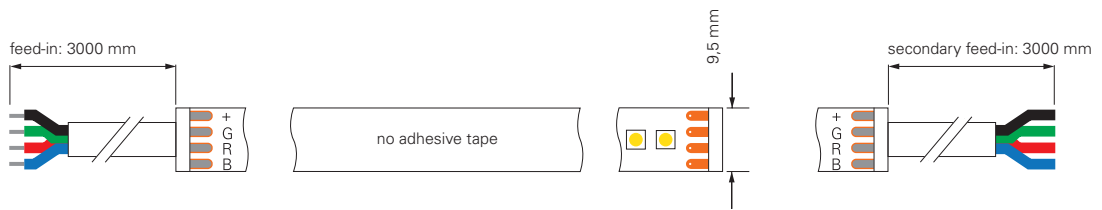
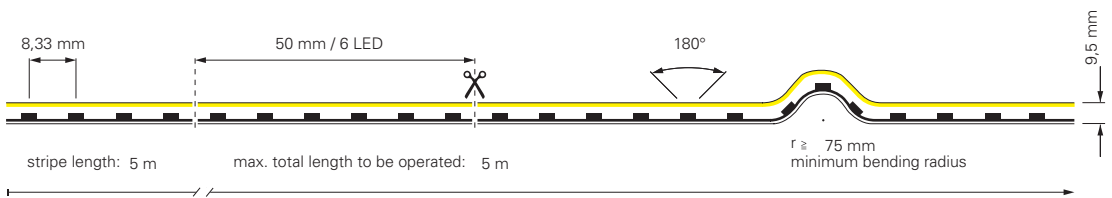

item	colour temperature	efficiency	light current	dimensions L	power	light source	price
840286	460-620 nm	32 lm/W	315 lm/m	5000 mm	10 W/m	120 LED/m	519,95 €

CV	24 Volt	SMD 4040		IP68	-15°C +50°C
----	---------	----------	--	------	----------------

incl. accessories: 10x retaining clip, 10x screw, 2x endcap

- 930446** profile for D Flex Line MINI aluminium anodized **14,94 €**
- 930445** profile for D Flex Line MINI plastic | transparent **10,95 €**
- 930531** assembly set for D Flex Line | 10 x 10 mm **10,95 €**
- 930593** gel glue for gluing the end caps 3g **5,95 €**





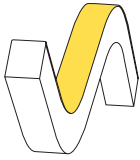

D FLEX LINE TOP VIEW IP68 RGBW

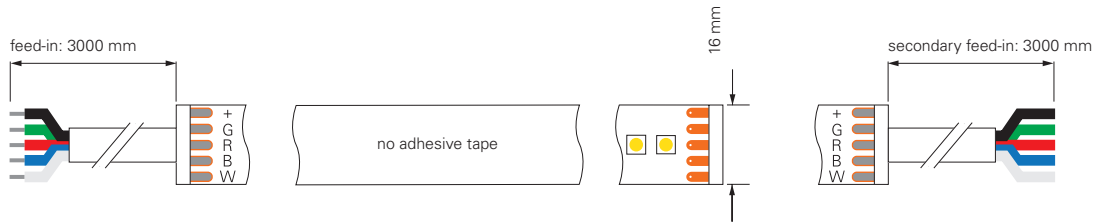
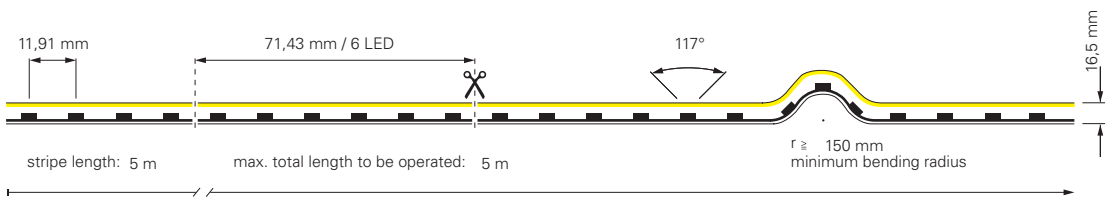

item	colour temperature	efficiency	light current	dimensions L	power	light source	price
840289	470-620 nm	30 lm/W	320 lm/m	5000 mm	10,5 W/m	84 LED/m	779,95 €



incl. accessories: 10x retaining clip, 10x screw, 2x endcap

- 930448** profile for D Flex Line TOP aluminium anodized **14,94 €**
- 930449** profile for D Flex Line TOP plastic | transparent **11,95 €**
- 930533** assembly set for D Flex Line | 16 x 15 mm **10,95 €**
- 930593** gel glue for gluing the end caps 3g **5,95 €**





SIDE VIEW

The LED stripe is arranged / installed vertically, which means that the flex stripe can be bent to the left and right. [note the respective minimum bending radius]

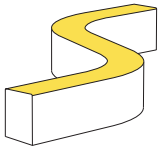

D FLEX LINE MINI SIDE VIEW IP44 3000K

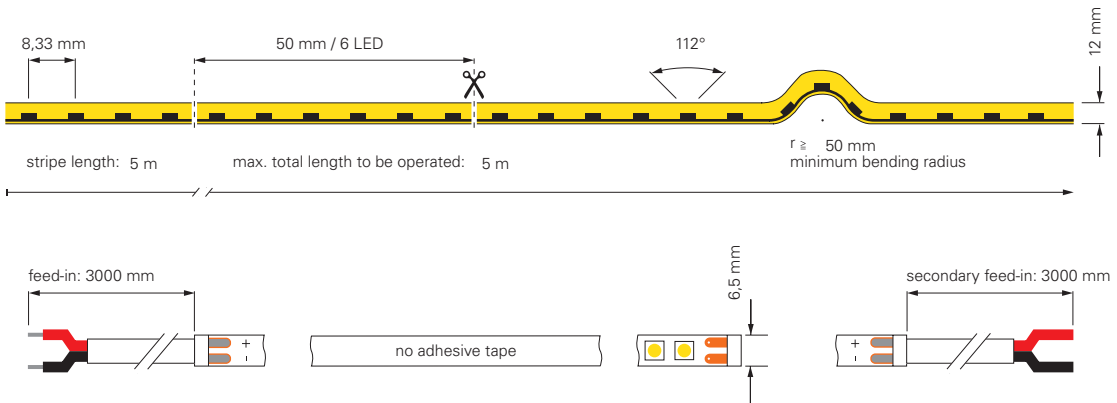

item	colour	temperature	efficiency	light current	dimensions L	power	light source	price
840376	ww	3000K	30 lm/W	285 lm/m	5000 mm	9,5 W/m	120 LED/m	359,95 €

CV	24 Volt	SMD 3014	Ra 90	1 CH	IP44	-15°C +50°C
----	---------	----------	-------	------	------	----------------

incl. accessories: 10x retaining clip, 10x screw, 2x endcap

930443	profile for D Flex Line aluminium anodized L x W x H: 1000 x 9 x 13 mm	12,95 €
930444	Flex profile for D Flex Line aluminium L x W x H: 500 x 9 x 12 mm	21,95 €
930530	assembly set for D Flex Line 6,5 x 12 mm	9,95 €
930593	gel glue for gluing the end caps 3g	5,95 €



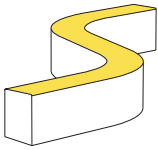

D FLEX LINE MINI SIDE VIEW IP68 3000K

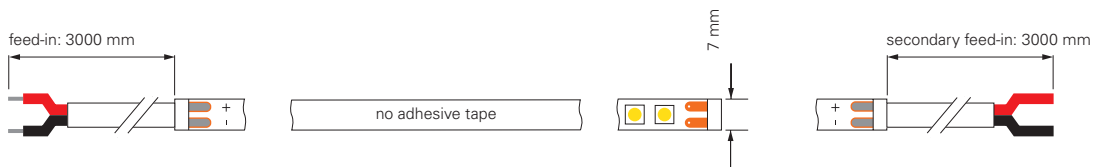
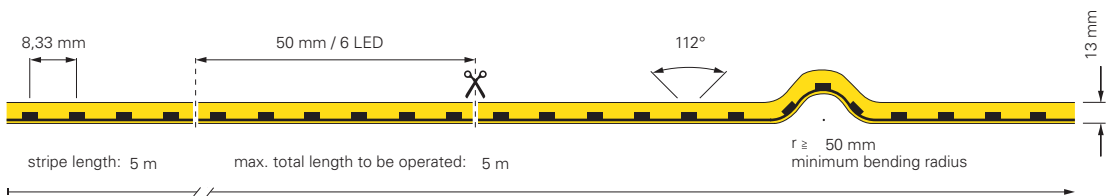

item	colour	temperature	efficiency	light current	dimensions L	power	light source	price
840283	ww	3000K	37 lm/W	295 lm/m	5000 mm	8 W/m	120 LED/m	559,95 €



incl. accessories: 10x retaining clip, 10x screw, 2x endcap

930443	profile for D Flex Line aluminium anodized L x W x H: 1000 x 9 x 13 mm	12,95 €
930444	Flex profile for D Flex Line aluminium L x W x H: 500 x 9 x 12 mm	21,95 €
930530	assembly set for D Flex Line 6,5 x 12 mm	9,95 €
930593	gel glue for gluing the end caps 3g	5,95 €



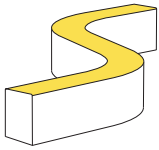

D FLEX LINE MINI SIDE VIEW IP68 3000K

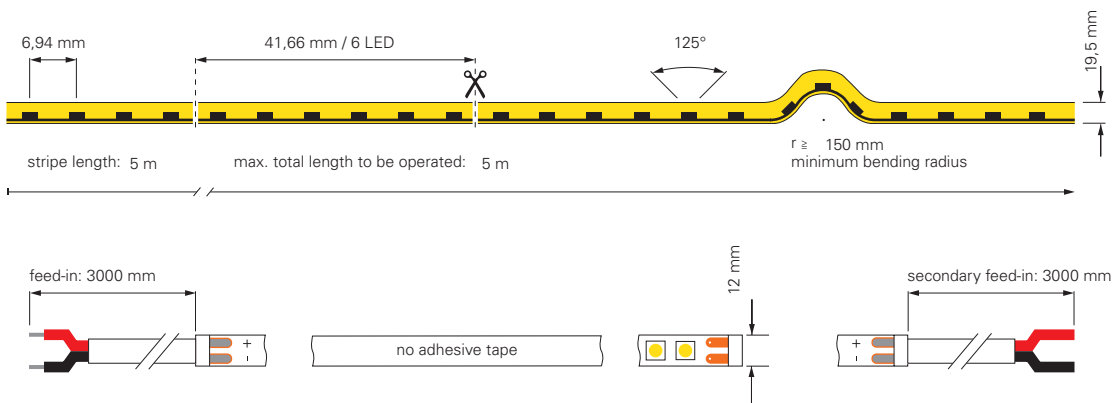

item	colour	temperature	efficiency	light current	dimensions L	power	light source	price
840287	ww	3000K	36 lm/W	368 lm/m	5000 mm	10,5 W/m	144 LED/m	799,95 €

CV	24 Volt	SMD 3014	Ra 80	1 CH	IP68	-15°C +50°C	A ↑ G	G
----	---------	----------	-------	------	------	----------------	-------------	---

incl. accessories: 10x retaining clip, 10x screw, 2x endcap

- 930447** profile for D Flex Line SIDE aluminium anodized **14,95 €**
L x W x H: 1000 x 15 x 21 mm
- 930451** Flex profile for D Flex Line Side aluminium **26,95 €**
L x W x H: 500 x 15 x 20 mm
- 930532** assembly set for D Flex Line | 12 x 20 mm **9,95 €**
- 930593** gel glue for gluing the end caps 3g **5,95 €**



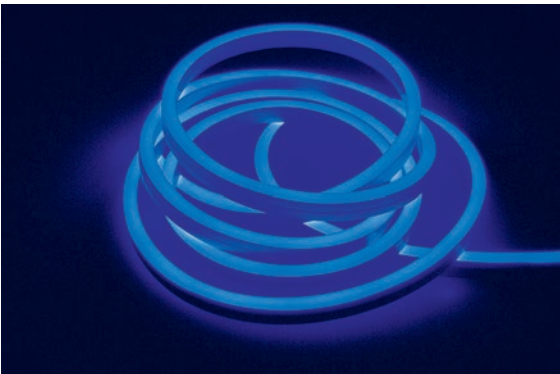
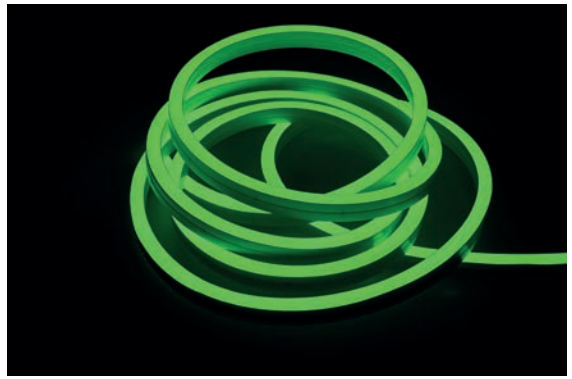
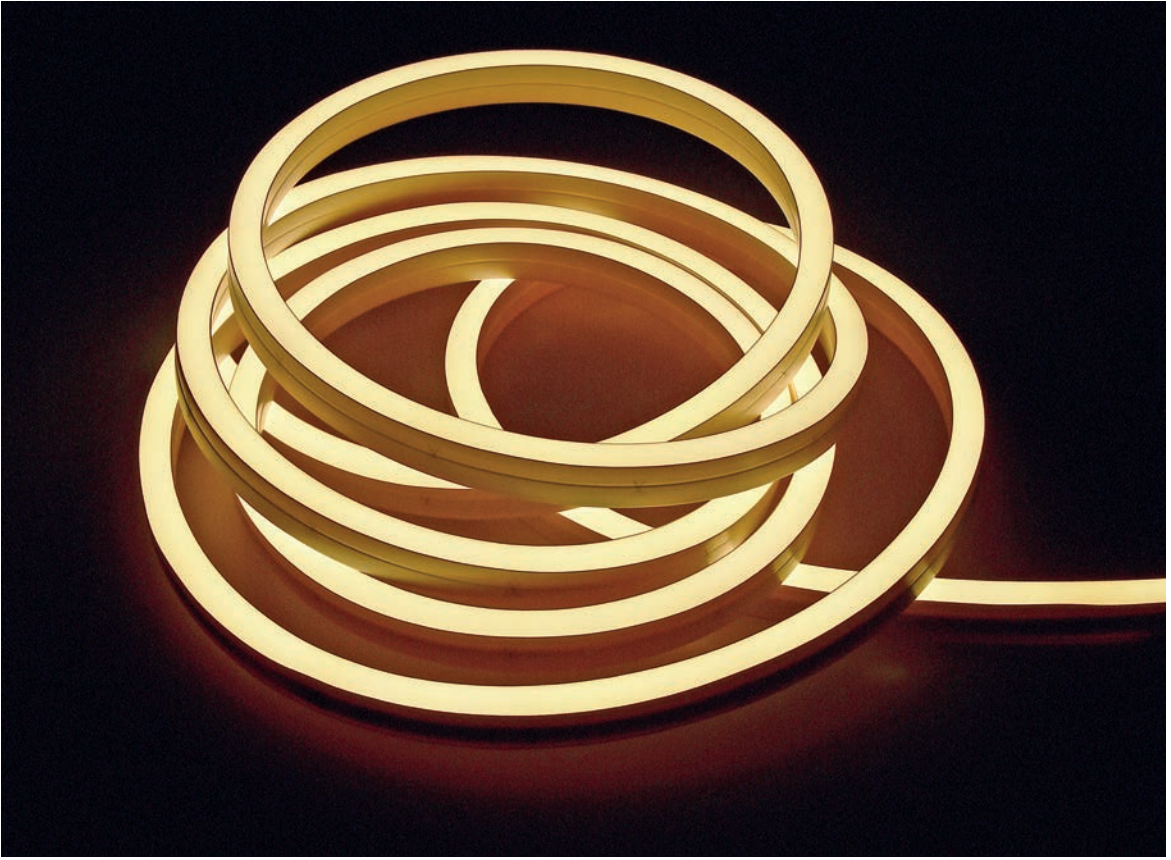

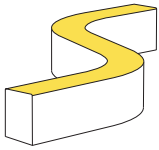

D FLEX LINE SIDE VIEW IP68 RGBW

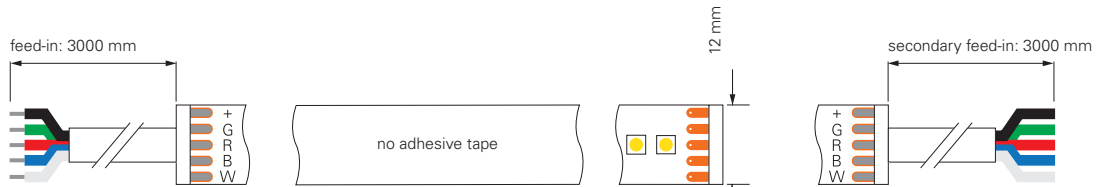
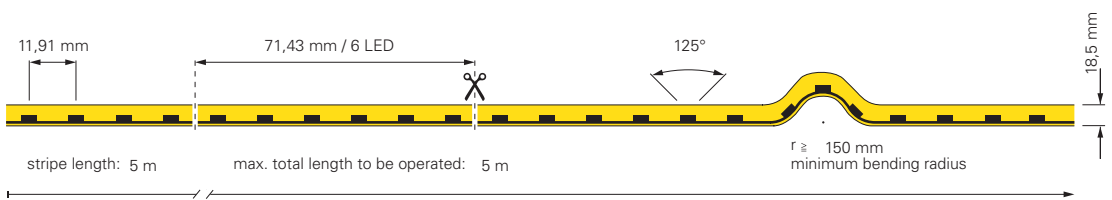

item	colour temperature	efficiency	light current	dimensions L	power	light source	price
840290	470-630 nm	20 lm/W	210 lm/m	5000 mm	10,5 W/m	84 LED/m	799,95 €



incl. accessories: 10x retaining clip, 10x screw, 2x endcap

- 930447** profile for D Flex Line SIDE aluminium anodized **14,95 €**
- 930451** Flex profile for D Flex Line Side aluminium **26,95 €**
- 930532** assembly set for D Flex Line | 12 x 20 mm **9,95 €**
- 930593** gel glue for gluing the end caps 3g **5,95 €**



230V | 1CH

This LED stripe is ideally suited if the requirements and focus are on flexible, water-protected and long-lasting lighting routes in indoor and outdoor areas.

Due to the voltage of 230V, no additional power supply unit is required. The delivery is ready for connection with mounted Schuko plug and moulded endcap.

The LED stripe can be dimmed from 100% to 40% by a phase on/phase off dimmer to suit the requirement or ambient lighting.

Applications of large distances, such as on buildings or hotel corridors can be operated in one piece up to 50m.





2835-84-230V-2700K-15M / 2700K-50M / 3000K-15M / 3000K-50M / 4000K-15M / 4000K-50M PVC-EXTRUSION

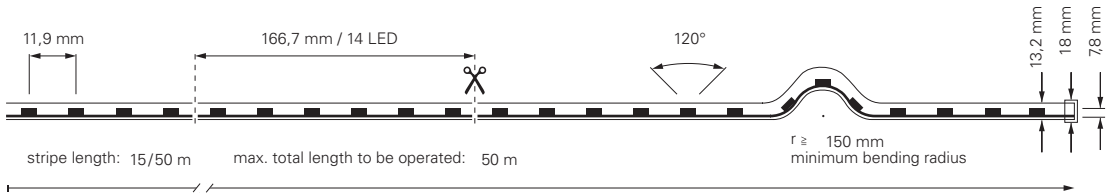

item	colour temperature	efficiency	light current	dimensions L	power	light source	price
840390	ww 2700K	103 lm/W	1442 lm/m	15000 mm	14 W/m	84 LED/m	769,95 €
840391	ww 2700K	103 lm/W	1442 lm/m	50000 mm	14 W/m	84 LED/m	2.499,95 €
840386	ww 3000K	105 lm/W	1470 lm/m	15000 mm	14 W/m	84 LED/m	769,95 €
840387	ww 3000K	105 lm/W	1470 lm/m	50000 mm	14 W/m	84 LED/m	2.499,95 €
840388	nw 4000K	114 lm/W	1596 lm/m	15000 mm	14 W/m	84 LED/m	769,95 €
840389	nw 4000K	114 lm/W	1596 lm/m	50000 mm	14 W/m	84 LED/m	2.499,95 €



840390, 840386, 840388 incl. 30 brackets with screws and dowels
840391, 840387, 840389 incl. 100 brackets with screws and dowels



930689	end caps set 2 pieces	4,95 €
930690	feed-in cable 300cm with IP44 contour plug	34,95 €
930691	flexible-connector 60cm	24,95 €
930692	mounting clamps set 10 pieces	9,95 €
930693	plastic mounting profile 100cm	14,95 €
930593	gel glue for gluing the end caps 3g	5,95 €

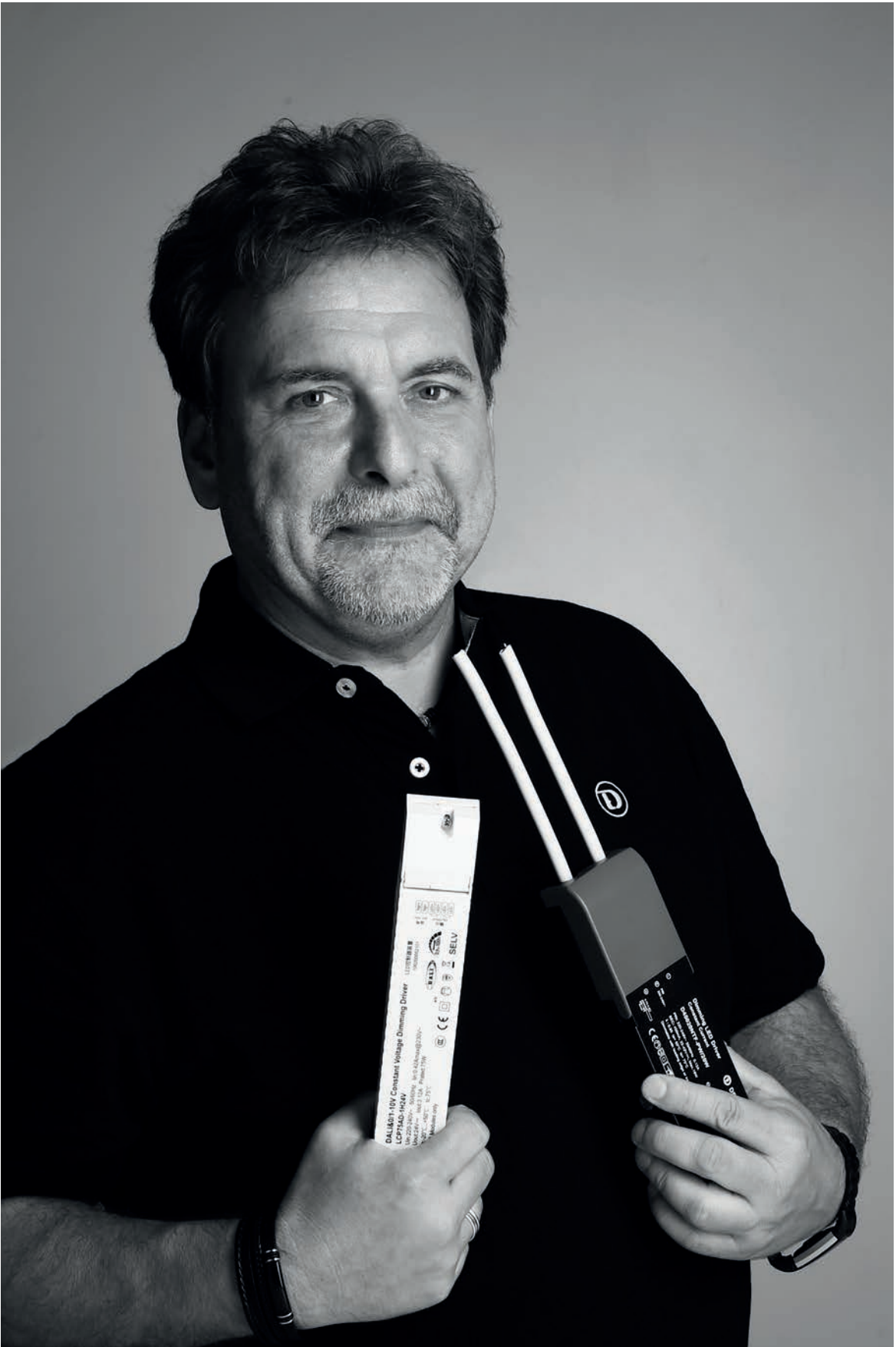

POWER SUPPLIES

- 720 power supplies | overview
- 722 technical information
- 724 DC | CV | quick finder
- 728 DC | CV
- 740 DC | CC | quick finder
- 743 DC | CC
- 754 DC | CC/CV
- 756 AC | CV | quick finder
- 756 AC | CV



DC | CV
not dimmable
from page 728



DC | CV
not dimmable | IP
from page 730



DC | CV
dimmable via
phase control
page 732



DC | CV
dimmable via phase
control or phase cut-off
from page 733



DC | CV
dimmable via 1-10V
from page 734



DC | CV |
dimmable via DALI /
0-10V / 1-10V / Touch-Dim
from page 736



DC | CV
dimmable via KNX
page 738



DC | CV
dimmable via CASAMBI
page 738



DC | CV
dimmable via DMX
page 739



DC | CC
not dimmable
from page 743



DC | CC
dimmable via
phase cut-off
from page 756



DC | CC
dimmable via phase
control or phase cut-off
page 749



DC | CC
dimmable via DALI /
DALI + Intelli-Touch-Dim
from page 750



DC | CC
dimmable via KNX
page 753



DC | CC/CV
dimmable via CASAMBI
page 754



DC | CC/CV
dimmable via phase
control or Touch-Dim
page 755



AC | CV
dimmable via phase
control or phase cut-off
page 756



AC | CV | dimmable via
leading edge
page 757



power supplies



PLANNING ELECTRICAL INSTALLATIONS EVEN BETTER

You will certainly notice the new technical data when browsing through our power supplies and ask yourself what it is all about? In future, we would like to support you even better in the planning and dimensioning of your installations. The background to this is that more and more power supplies for lighting are already being installed in standard buildings [directly in the luminaires or as an external power supply].

Due to the inrush currents inherent in the design, e.g. after a power failure and the subsequent simultaneous start of all power supplies, an overload of the circuit breakers may occur. In order to be able to take this into account during the planning stage, we provide you with the necessary data for all our power supplies.

INRUSH CURRENT

In future, you will find the specification of the maximum inrush current directly with our power supply units. The maximum current value [amperes/A], is specified in connection with the respective time [microseconds/ μ s] and defines when exactly the highest current consumption occurs after the mains voltage is applied. You will find this limit value again with many manufacturers in the data sheets of corresponding components, as this can lead to an overload/damage.

DEKO-LIGHT POWER SUPPLIES | DESIGN FLAT

- plastic housing
- suitable for indoor use
- flicker free
- short-circuit proof and overload protection
- overheat control

872629	12V	6W	0-500mA	7A/300 μ s	98 x 46 x 11 mm	16,95 €
862231	12V	12W	0-1000mA	8A/300 μ s	128 x 50 x 13 mm	21,95 €
862232	12V	20W	0-1670mA	12A/300 μ s	128 x 50 x 14 mm	25,95 €
862121	12V	50W	0-4160mA	15A/300 μ s	185 x 62 x 22 mm	52,95 €

HOW MANY POWER SUPPLY UNITS PER CIRCUIT BREAKER?

The maximum number of power supply units that may be connected to the respective circuit breaker is directly dependent on the inrush current. In our quick finders you will find the number for the most common types of circuit breaker [B10A, B16A, C10A, C16A].

CAPACITIVE LOAD OF POWER SUPPLIES

Due to their design, power supplies sometimes represent very different capacitive loads. Especially in combination with motion detectors, twilight switches or switching/dimming actuators, this value [as with the capacitor in nF/pF], which is available for many power supplies and specified in our quick finders, plays an important role with regard to the suitability and durability of all components. Please also refer to the manufacturer's data sheets.

electr. data		dimmable via							usage / design			electrical limit values		power supply	
voltage	power	leading edge / cut-off	1 - 10V	touch dimmer [push]	DMX	DALI	KNX	CASAMBI-App	indoor	outdoor	design	capacitive load	max. quantity per automatic circuit breaker	item number	page
12V	2,5-25 W	x							x		basic	31.16nF	B10=35, B16=56, C10=35, C16=56	862240	733
12V	40 W								x		basic	251.7nF	B10A=11, B16A=18, C10A=24, C16A=39	862162	730

WIRE CROSS SECTION

When installing voltage-stable [CV] or current-stable [CC] power supply units and associated components, always ensure that the cable cross-sections are sufficiently dimensioned, especially with regard to the dependence of the cable length.

12 V	2 m	5 m	10 m	12 m
25 W	0,25	0,75	1,50	[2,50]
50 W	0,75	1,50	4,00	[4,00]
75 W	1,00	2,50	4,00	[6,00]
100 W	1,50	4,00	6,00	[10,00]
125 W	1,50	4,00	10,00	[10,00]
150 W	2,50	6,00	10,00	-
200 W	2,50	6,00	-	-
300 W	4,00	10,00	-	-
400 W	6,00	-	-	-

The specified cable cross-sections [mm²] were adapted to the commercially available cross-sections. The maximum cable length of 10 m should not be exceeded. »Red values« must be avoided urgently.

24 V	2 m	5 m	10 m	12 m
25 W	0,25	0,25	0,50	[0,50]
50 W	0,25	0,50	0,75	[1,00]
75 W	0,25	0,75	1,00	[1,50]
100 W	0,50	0,75	1,50	[2,50]
125 W	0,50	1,00	2,50	[2,50]
150 W	0,50	1,50	2,50	[4,00]
200 W	0,75	1,50	4,00	[4,00]
300 W	1,00	2,50	6,00	-
400 W	1,50	4,00	6,00	-

48 V	2 m	5 m	10 m	12 m
25 W	0,25	0,25	0,25	[0,25]
50 W	0,25	0,25	0,25	[0,25]
75 W	0,25	0,25	0,50	[0,50]
100 W	0,25	0,25	0,50	[0,50]
125 W	0,25	0,25	0,50	[0,75]
150 W	0,25	0,50	0,75	[0,75]
200 W	0,25	0,50	1,00	[1,00]
300 W	0,25	0,75	1,50	[1,50]
400 W	0,50	1,00	2,50	[2,50]

DO YOU KNOW OUR LONG-FLAT POWER SUPPLIES?

These power supply units are now available with a power of up to 240 watts and due to their compact dimensions, they are ideally suited for installation in ceiling coves, shadow gaps or all other installation situations with little space.

All Long-Flat power supplies can be found on page 729



electr. data		dimmable via							usage / design			electrical limit values		power supply	
voltage	power	leading edge / cut-off	1 - 10V	touch dimmer [push]	DMX	DALI	KNX	CASAMBI-App	indoor	outdoor	design	capacitive load	max. quantity per automatic circuit breaker	item number	page
12V	4 W								x	x	mini		B10A=17, B16A=28, C10A=37, C16A=59	872127	728
12V	6 W								x		flat	38.83nF	B10A=17, B16A=28, C10A=37, C16A=59	872629	729
12V	12 W								x	x	octo	101uF	B10A=17, B16A=27, C10A=36, C16A=58	862229	728
12V	12 W								x		flat		B10A=17, B16A=27, C10A=36, C16A=58	862231	729
12V	20 W								x		flat	938uF	B10A=17, B16A=27, C10A=36, C16A=58	862232	729
12V	2,5-25 W	x							x		basic	31.16nF	B10=35, B16=56, C10=35, C16=56	862240	733
12V	40 W								x		basic	251.7nF	B10A=11, B16A=18, C10A=24, C16A=39	862162	730
12V	40 W								x	x	IP	621.5nF	B10A=5, B16A=9, C10A=12, C16A=19	872082	730
12V	40 W								x	x	IP		B10A=6, B16A=9, C10A=10, C16A=16	872097	731
12V	40 W		x	x		x			x		basic		B10A=18, B16A=28, C10A=36, C16A=56	862253	736
12V	45 W								x		long-flat	462.1nF	B10A=5, B16A=9, C10A=12, C16A=19	862123	729
12V	50 W								x		flat	485.5nF	B10A=11, B16A=18, C10A=24, C16A=39	862121	729
12V	12-50 W	x							x		basic	1924uF	B10A=17, B16A=28, C10A=17, C16A=28	862220	733
12V	60 W								x		long-flat	462.1nF	B10A=5, B16A=9, C10A=12, C16A=19	862093	729
12V	60 W								x	x	IP		B10A=6, B16A=9, C10A=10, C16A=16	872098	731
12V	60 W						x		x	x	IP		B10A=6, B16A=9, C10A=10, C16A=16	872109	738
12V	60 W						x		x		basic		B10A=6, B16A=9, C10A=10, C16A=16	862249	738
12V	75 W								x		basic	870nF	B10A=11, B16A=18, C10A=24, C16A=39	862127	730
12V	75 W								x	x	IP	621.5nF	B10A=5, B16A=8, C10A=10, C16A=16	872084	730
12V	75 W		x	x		x			x		basic		B10A=10, B16A=16, C10A=20, C16A=32	862254	736
12V	90 W								x	x	IP		B10A=2, B16A=3, C10A=3, C16A=6	872099	731
12V	100 W								x		basic	842.2nF	B10A=3, B16A=5, C10A=7, C16A=11	862165	730
12V	100 W								x	x	IP	621.5nF	B10A=3, B16A=5, C10A=7, C16A=11	872093	730
12V	100 W								x		long-flat	462.1nF	B10A=3, B16A=5, C10A=7, C16A=11	862125	729
12V	33-100 W	x							x	x	IP	93,14nF	B10=7, B16=15, C10=7, C16=15	872135	733
12V	34-100 W	x							x		basic	146,34nF	B10=7, B16=15, C10=7, C16=15	862241	733

electr. data		dimmable via							usage / design			electrical limit values		power supply	
voltage	power	leading edge / cut-off	1 - 10V	touch dimmer [push]	DIMX	DALI	KNX	CASAMBI-App	indoor	outdoor	design	capacitive load	max. quantity per automatic circuit breaker	item number	page
12V	120 W								x	x	IP		B10A=2, B16A=4, C10A=4, C16A=6	872100	731
12V	120 W						x		x		IP		B10A=2, B16A=4, C10A=4, C16A=6	872110	738
12V	120 W							x	x		IP		B10A=2, B16A=4, C10A=4, C16A=6	862250	738
12V	135 W				x				x		*		B10A=7, B16A=12, C10A=16, C16A=25	843274	739
12V	150 W								x		long-flat	462.1nF	B10A=3, B16A=5, C10A=6, C16A=10	862172	729
12V	150 W								x		basic	591.2nF	B10A=2, B16A=4, C10A=6, C16A=9	862167	730
12V	150 W								x	x	IP	621.5nF	B10A=2, B16A=4, C10A=6, C16A=9	872086	730
12V	150 W		x						x	x	IP		B10A=3, B16A=5, C10A=6, C16A=10	872011	734
12V	200 W		x	x		x			x		basic		B10A=3, B16A=5, C10A=5, C16A=9	862160	735
12V	66-200 W	x							x	x	IP	148,64nF	B10=3, B16=7, C10=3, C16=7	872137	733
12V	200 W								x	x	IP	621.5nF	B10A=2, B16A=3, C10A=4, C16A=7	872088	730
12V	200 W						x		x		IP		B10A=2, B16A=4, C10A=4, C16A=6	872111	738
24V	4 W								x	x	mini		B10A=59, B16A=94, C10A=123, C16A=197	872128	728
24V	6 W								x		flat	43.5nF	B10A=17, B16A=28, C10A=37, C16A=59	872630	729
24V	12 W								x	x	octo	620uF	B10A=17, B16A=27, C10A=36, C16A=58	862230	728
24V	12 W								x		flat	311uF	B10A=17, B16A=27, C10A=36, C16A=58	862233	729
24V	20 W								x		flat	446uF	B10A=17, B16A=27, C10A=36, C16A=58	862234	729
24V	2,5-25 W	x							x		basic	9520uF	B10=35, B16=56, C10=35, C16=56	862221	733
24V	40 W								x		basic	762nF	B10A=11, B16A=18, C10A=24, C16A=39	862163	730
24V	40 W								x	x	IP	626.3nF	B10A=5, B16A=9, C10A=12, C16A=19	872083	730
24V	40 W								x	x	IP		B10A=6, B16A=9, C10A=10, C16A=16	872101	731
24V	40 W		x	x		x			x		basic		B10A=18, B16A=28, C10A=36, C16A=56	862255	736
24V	45 W								x		long-flat	451.2nF	B10A=5, B16A=9, C10A=12, C16A=19	862124	729
24V	12-50 W	x							x		basic	10520uF	B10A=17, B16A=28, C10A=17, C16A=28	862222	733
24V	50 W								x		flat	604.5nF	B10A=11, B16A=18, C10A=24, C16A=39	862122	729
24V	60 W		x						x		*		B10A=10, B16A=16, C10A=10, C16A=16	872817	734

electr. data		dimmable via							usage / design			electrical limit values		power supply	
voltage	power	leading edge / cut-off	1 - 10V	touch dimmer [push]	DMX	DALI	KNX	CASAMBI-App	indoor	outdoor	design	capacitive load	max. quantity per automatic circuit breaker	item number	page
		x	x	x	x	x	x	x	x	x	x				
24V	60 W								x		long-flat	451.2nF	B10A=5, B16A=9, C10A=12, C16A=19	862094	729
24V	60 W								x	x	IP		B10A=6, B16A=9, C10A=10, C16A=16	872102	731
24V	60 W						x		x		IP		B10A=6, B16A=9, C10A=10, C16A=16	872112	738
24V	12-60 W	x							x	x	*			872045	732
24V	60 W						x		x		basic		B10A=6, B16A=9, C10A=10, C16A=16	862251	738
24V	75 W								x		basic	760nF	B10A=11, B16A=18, C10A=24, C16A=39	862164	730
24V	75 W								x	x	IP	626.3nF	B10A=5, B16A=8, C10A=10, C16A=16	872085	730
24V	75 W		x	x		x			x		basic		B10A=10, B16A=16, C10A=20, C16A=32	862256	736
24V	90 W								x	x	IP		B10A=2, B16A=3, C10A=3, C16A=6	872103	731
24V	100 W								x		basic	724.2nF	B10A=3, B16A=5, C10A=7, C16A=11	862166	730
24V	33-100 W	x							x		IP	94,13nF	B10=7, B16=15, C10=7, C16=15	872136	747
24V	34-100 W	x							x		basic	140.74nF	B10=7, B16=15, C10=7, C16=15	862242	733
24V	100 W								x		long-flat	451.2nF	B10A=3, B16A=5, C10A=7, C16A=11	862126	729
24V	100 W								x	x	IP	626.3nF	B10A=3, B16A=5, C10A=7, C16A=11	872094	730
24V	120 W								x	x	IP		B10A=2, B16A=4, C10A=4, C16A=6	872104	731
24V	120 W						x		x	x	IP		B10A=2, B16A=4, C10A=4, C16A=6	872113	738
24V	120 W						x		x		basic		B10A=2, B16A=4, C10A=4, C16A=6	862252	738
24V	135 W				x				x		*		B10A=7, B16A=12, C10A=16, C16A=25	843275	739
24V	150 W								x		basic	591.2nF	B10A=2, B16A=4, C10A=6, C16A=9	862168	730
24V	150 W								x		long-flat	451.2nF	B10A=3, B16A=5, C10A=6, C16A=10	862173	729
24V	150 W								x	x	IP	626.3nF	B10A=2, B16A=4, C10A=6, C16A=9	872087	730
24V	30-150 W	x							x	x	*			872046	732
24V	150 W					x			x		basic		B10A=5, B16A=9, C10A=10 C16A=18	862262	736
24V	200 W		x	x		x			x		basic		B10A=4, B16A=6, C10A=7, C16A=12	862161	735
24V	200 W						x		x		IP		B10A=2, B16A=4, C10A=4, C16A=6	872114	738
24V	66-200 W	x							x	x	IP	148.64nF	B10=3, B16=7, C10=3, C16=7	872138	733

electr. data		dimmable via							usage / design			electrical limit values		power supply	
voltage	power	leading edge / cut-off		touch dimmer [push]	DMX	DALI	KNX	CASAMBI-App	indoor	outdoor	design	capacitive load	max. quantity per automatic circuit breaker	item number	page
		1 - 10V													
24V	240 W								x	x	IP	626.3nF	B10A=2, B16A=3, C10A=4, C16A=7	872089	730
24V	240 W								x		long-flat	5600uF	B10A=1, B16A=2, C10A=3, C16A=5	862265	729
24V	240 W					x			x		basic		B10A=3, B16A=5, C10A=6, C16A=10	862263	736
24V	320 W								x	x	IP	626.3nF	B10A=2, B16A=3, C10A=4, C16A=6	872091	730
48V	40 W								x	x	IP		B10A=6, B16A=9, C10A=10, C16A=16	872105	731
48V	60 W								x	x	IP		B10A=6, B16A=9, C10A=10, C16A=16	872106	731
48V	75 W								x	x	IP		B10A=4, B16A=7, C10A=7, C16A=11	872116	731
48V	75 W		x						x	x	IP		B10A=4, B16A=7, C10A=7, C16A=11	872117	735
48V	75 W					x			x	x	IP		B10A=4, B16A=7, C10A=7, C16A=11	872118	737
48V	90 W								x	x	IP		B10A=2, B16A=3, C10A=3, C16A=6	872107	731
48V	33-100 W	x							x		IP	6,6uF	B10=3 B16=5, C10=7, C16=11	872142	733
48V	120 W								x	x	IP		B10A=2, B16A=4, C10A=4, C16A=6	872108	731
48V	150 W								x	x	IP		B10A=2, B16A=3, C10A=3, C16A=5	872119	731
48V	150 W		x						x	x	IP		B10A=2, B16A=3, C10A=3, C16A=5	872120	735
48V	150 W					x			x	x	IP		B10A=2, B16A=3, C10A=3, C16A=5	872121	737
48V	66-200 W	x							x	x	IP	6,6uF	B10=2, B16=3, C10=4 C16=7	872143	733
48V	200 W						x		x		IP		B10A=2, B16A=4, C10A=4, C16A=6	872115	738
48V	240 W								x	x	IP		B10A=2, B16A=4, C10A=4, C16A=6	872122	731
48V	240 W		x						x	x	IP		B10A=2, B16A=4, C10A=4, C16A=6	872123	735
48V	240 W					x			x	x	IP		B10A=2, B16A=4, C10A=4, C16A=6	872124	737
48V	600 W								x	x	IP		B10A=1, B16A=1, C10A=1, C16A=2	872125	731

power supplies design



mini



round / octo



flat



basic



long-flat



IP

* special design

POWER SUPPLIES

DC | CV
not dimmable

IP

DEKO-LIGHT POWER SUPPLIES | DESIGN MINI

- plastic housing
- suitable for indoor and outdoor use
- flicker free
- short-circuit proof and overload protection



item	colour	voltage	power	electricity	max. inrush current	dimensions L x W x H	price
872127	■ black	12V	4W	0-330mA	5A/260µs	38 x 27 x 21 mm	12,95 €
872128	■ black	24V	4W	0-170 mA	5A/260µs	38 x 27 x 21 mm	12,95 €



IP

DEKO-LIGHT POWER SUPPLIES | DESIGN OCTO

- plastic housing
- suitable for indoor and outdoor use
- flicker free
- short-circuit proof and overload protection



item	colour	voltage	power	electricity	max. inrush current	dimensions L x W x H	price
862229	■ black	12V	12W	0-1000mA	15A/200µs	50 x 48 x 24 mm	21,95 €
862230	■ black	24V	12W	0-500mA	15A/200µs	50 x 48 x 24 mm	21,95 €



POWER SUPPLIES

DC | CV
not dimmable

DEKO-LIGHT POWER SUPPLIES | DESIGN FLAT

- plastic housing
- suitable for indoor use
- ideal for concealed mounting in ceiling coving
- flicker free
- short-circuit proof and overload protection
- overheat control



design example

item	colour	voltage	power	electricity	max. inrush current	dimensions L x W x H	price
872629	■ black	12V	6W	0-500mA	7A/300µs	98 x 46 x 11 mm	16,95 €
862231	■ black	12V	12W	0-1000mA	15A/200µs	128 x 50 x 13 mm	21,95 € NEW
862232	■ black	12V	20W	0-1670mA	20A/100µs	128 x 50 x 13 mm	25,95 €
862121	■ black	12V	50W	0-4160mA	15A/300µs	185 x 62 x 22 mm	52,95 €
872630	■ black	24V	6W	0-250mA	7A/300µs	98 x 46 x 11 mm	16,95 €
862233	■ black	24V	12W	0-500mA	15A/200µs	128 x 50 x 13 mm	21,95 €
862234	■ black	24V	20W	0-830mA	20A/100µs	128 x 50 x 13 mm	25,95 €
862122	■ black	24V	50W	0-2100mA	15A/300µs	185 x 62 x 22 mm	52,95 €



DEKO-LIGHT POWER SUPPLIES | DESIGN LONG-FLAT

design example

- plastic housing
- suitable for indoor use
- ideal for concealed mounting in ceiling coving
- flicker free
- short-circuit proof and overload protection
- overheat control

item	colour	voltage	power	electricity	max. inrush current	dimensions L x W x H	price
862123	■ black	12V	45W	0-3750mA	30A/300µs	251 x 30 x 16 mm	49,95 €
862093	□ white	12V	60W	0-5000mA	30A/300µs	305 x 30 x 17 mm	59,95 €
862125	■ black	12V	100W	0-8340mA	50A/300µs	312 x 30 x 18 mm	96,95 €
862172	■ black	12V	150W	0-12500mA	60A/300µs	335 x 30 x 22 mm	129,95 €
862124	■ black	24V	45W	0-1870mA	30A/300µs	251 x 30 x 16 mm	49,95 €
862094	■ black	24V	60W	0-2500mA	30A/300µs	305 x 30 x 17 mm	59,95 €
862126	■ black	24V	100W	0-4170mA	50A/300µs	312 x 30 x 18 mm	96,95 €
862173	■ black	24V	150W	0-6250mA	60A/300µs	335 x 30 x 22 mm	129,95 €
862265	■ black	24V	240W	0-10000mA	120A/500µs	357 x 32 x 23 mm	159,95 € NEW



POWER SUPPLIES

DC | CV
not dimmable

DEKO-LIGHT POWER SUPPLIES | DESIGN BASIC

- plastic housing
- suitable for indoor use
- flicker free
- short-circuit proof and overload protection
- overheat control



design example

item	colour	voltage	power	electricity	max. inrush current	dimensions L x W x H	price
862162	■ black	12V	40W	0-3000 mA	15A/300µs	166 x 52 x 24 mm	46,95 €
862127	■ black	12V	75W	0-6300 mA	15A/300µs	184 x 61 x 32 mm	74,95 €
862165	■ black	12V	100W	0-8300 mA	50A/300µs	184 x 61 x 32 mm	96,95 €
862167	■ black	12V	150W	0-12500 mA	60A/300µs	210 x 67 x 34 mm	129,95 €
862163	■ black	24V	40W	0-1700 mA	15A/300µs	166 x 52 x 24 mm	46,95 €
862164	■ black	24V	75W	0-3100 mA	15A/300µs	184 x 61 x 32 mm	74,95 €
862166	■ black	24V	100W	0-4200 mA	50A/300µs	184 x 61 x 32 mm	96,95 €
862168	■ black	24V	150W	0-6250 mA	60A/300µs	210 x 67 x 34 mm	129,95 €



DEKO-LIGHT POWER SUPPLIES | DESIGN IP

- aluminium housing
- suitable for indoor and outdoor use
- flicker free
- short-circuit proof and overload protection
- overheat control



design example

item	colour	voltage	power	electricity	max. inrush current	dimensions L x W x H	price
872082	■ anthrazit	12V	40W	0-3340 mA	30A/300µs	182 x 58 x 30,5 mm	74,95 €
872084	■ anthrazit	12V	75W	0-6250 mA	35A/300µs	186 x 64 x 39 mm	94,95 €
872093	■ anthrazit	12V	100W	0-8340 mA	50A/300µs	186 x 64 x 39 mm	114,95 €
872086	■ anthrazit	12V	150W	0-12500 mA	60A/300µs	191 x 70 x 40 mm	149,95 €
872088	■ anthrazit	12V	200W	0-16600 mA	75A/300µs	249 x 72 x 41 mm	179,95 €
872083	■ anthrazit	24V	40W	0-1670 mA	30A/300µs	182 x 58 x 30,5 mm	74,95 €
872085	■ anthrazit	24V	75W	0-3125 mA	35A/300µs	199 x 67 x 35 mm	94,95 €
872094	■ anthrazit	24V	100W	0-4170 mA	50A/300µs	186 x 64 x 39 mm	114,95 €
872087	■ anthrazit	24V	150W	0-6250 mA	60A/300µs	191 x 70 x 40 mm	149,95 €
872089	■ anthrazit	24V	240W	0-10000 mA	75A/300µs	249 x 72 x 41 mm	184,95 €
872091	■ anthrazit	24V	320W	0-13340 mA	85A/300µs	252 x 90 x 44 mm	219,95 €



POWER SUPPLIES

DC | CV
not dimmable

IP

MEANWELL POWER SUPPLIES NPF-SERIES

- plastic housing
- suitable for indoor and outdoor use
- flicker free
- short-circuit proof and overload protection
- overheat control



design example

item	colour	voltage	power	electricity	max. inrush current	dimensions L x W x H	price
872097	■ black	12V	40W	0-3340mA	50A/270µs	150 x 53 x 35 mm	84,95 €
872098	■ black	12V	60W	0-5000mA	50A/270µs	150 x 53 x 35 mm	94,95 €
872099	■ black	12V	90W	0-7500mA	60A/550µs	171 x 63 x 38 mm	119,95 €
872100	■ black	12V	120W	0-10000mA	60A/520µs	191 x 63 x 38 mm	139,95 €
872101	■ black	24V	40W	0-1670mA	50A/270µs	150 x 53 x 35 mm	84,95 €
872102	■ black	24V	60W	0-2500mA	50A/270µs	150 x 53 x 35 mm	94,95 €
872103	■ black	24V	90W	0-3750mA	60A/550µs	171 x 63 x 38 mm	119,95 €
872104	■ black	24V	120W	0-5000mA	60A/520µs	191 x 63 x 38 mm	139,95 €
872105	■ black	48V	40W	0-840mA	50A/270µs	150 x 53 x 35 mm	84,95 €
872106	■ black	48V	60W	0-1250mA	50A/270µs	150 x 53 x 35 mm	94,95 €
872107	■ black	48V	90W	0-1880mA	60A/550µs	171 x 63 x 38 mm	119,95 €
872108	■ black	48V	120W	0-2500mA	60A/520µs	191 x 63 x 38 mm	139,95 €



MEANWELL POWER SUPPLIES ELG/HLG-SERIES

- aluminium housing
- suitable for indoor and outdoor use
- flicker free
- short-circuit proof and overload protection
- overheat control
- output voltage/current adjustable via int. potentiometers



design example

item	colour	voltage	power	electricity	max. inrush current	dimensions L x W x H	price
872116	□ silver coloured	ELG	48V	75W	0-1600mA	180 x 63 x 36 mm	99,95 €
872119	□ silver coloured	ELG	48V	150W	0-3130mA	219 x 63 x 36 mm	169,95 €
872122	□ silver coloured	ELG	48V	240W	0-5000mA	244 x 71 x 38 mm	199,95 €
872125	□ silver coloured	HLG	48V	600W	0-12500mA	280 x 144 x 49 mm	489,95 €





ABN SAFETY ISOLATING TRANSFORMER [DC] ACCORDING TO DIN 2006-7 EN 61558-2-6: 2010-04 PRIMARY DIMMABLE

A safety transformer requires stronger or double insulation and stricter checks apply. It is therefore suitable for applications

according to DIN EN 61558 in the area of increased personal protection, e. g. for the operation of luminaires which are installed in swimming pools, fountains, wet cells or similar.



design example

LED SAFETY ISOLATING TRANSFORMER

- dimmable via leading edge
- maximum load: 80% continuous operation
- suitable for indoor and outdoor use

item	colour	voltage	power	dimensions L x W x H	price
872045	■ black	24V	12 - 60W	150 x 90 x 70 mm	369,90 €
872046	■ black	24V	30 - 150W	176 x 116 x 110 mm	599,95 €



POWER SUPPLIES

DC | CV
dimmissible

DEKO-LIGHT POWER SUPPLIES | DESIGN BASIC PRIMARY DIMMABLE

- plastic housing
- suitable for indoor use
- ideal for upgrade existing installations, as primarily with commercially available rotary / touch dimmers [C-capable, via phase angle or section] dimmable
- cannot be combined with PWM dimmers such as RF, DMX, DALI or KNX
- flicker free
- short-circuit proof and overload protection
- overheat control



design example

item	colour	voltage	power	max. inrush current	dimensions L x W x H	price
862240	■ black	12V	2,5 - 25W	10A/100µs	122 x 52 x 30 mm	54,95 €
862220	■ black	12V	12,0 - 50W	20A/100µs	184 x 61 x 33 mm	74,95 €
862241	■ black	12V	34,0 - 100W	45A/100µs	210 x 67 x 34 mm	144,95 €
862221	■ black	24V	2,5 - 25W	10A/100µs	122 x 52 x 30 mm	54,95 €
862222	■ black	24V	12,0 - 50W	20A/100µs	184 x 61 x 33 mm	74,95 €
862242	■ black	24V	34,0 - 100W	45A/100µs	210 x 67 x 34 mm	144,95 €



DEKO-LIGHT POWER SUPPLIES | DESIGN IP PRIMARY DIMMABLE

- metal housing
- suitable for indoor and outdoor use
- ideal for upgrade existing installations, as primarily with commercially available rotary / touch dimmers [C-capable, via phase angle or section] dimmable
- cannot be combined with PWM dimmers such as RF, DMX, DALI or KNX
- flicker free
- short-circuit proof and overload protection
- overheat control



design example

item	colour	voltage	power	max. inrush current	dimensions L x W x H	price
872135	□ silver coloured	12V	33 - 100W	45A/100µs	191 x 70 x 40 mm	169,95 €
872137	□ silver coloured	12V	66 - 200W	45A/100µs	249 x 72 x 40 mm	206,95 €
872136	□ silver coloured	24V	33 - 100W	45A/100µs	191 x 70 x 40 mm	169,95 €
872138	□ silver coloured	24V	66 - 200W	45A/100µs	249 x 72 x 40 mm	206,95 €
872142	□ silver coloured	48V	33 - 100W	45A/100µs	191 x 70 x 40 mm	169,95 € NEW
872143	□ silver coloured	48V	66 - 200W	45A/100µs	249 x 72 x 40 mm	206,95 € NEW



POWER SUPPLIES

DC | CV
dimmable

IP



DEKO-LIGHT POWER SUPPLIES | DESIGN IP

- aluminium housing
- suitable for indoor and outdoor use
- short-circuit proof and overload protection
- overheat control
- dimmable via 1 - 10V

item	colour	voltage	power	electricity	max. inrush current	dimensions L x W x H	price
872011	<input type="checkbox"/> silver coloured	12V	150W	0-12500mA	60A/300µs	223 x 70 x 40 mm	149,95 €



HEP POWER SUPPLY LAV60W

- metal housing
- suitable for indoor use
- short-circuit proof and overload protection
- overheat control
- dimmable via 1 - 10V

item	colour	voltage	power	electricity	max. inrush current	dimensions L x W x H	price
872817	<input type="checkbox"/> white	24V	60W	0-2500 mA	37,4A/171µs	280 x 30 x 27,5 mm	91,95 €



POWER SUPPLIES

DC | CV
dimnable



DEKO-LIGHT POWER SUPPLIES | DESIGN BASIC

- aluminium housing
- suitable for indoor use
- short-circuit proof and overload protection
- overheat control
- dimmable via 0-10V / 1-10V, Touch-Dim [Push]
or DALI Bus according to IEC 62386

item	colour	voltage	power	electricity	max. inrush current	dimensions L x W x H	price
862160	■ black	12V	200W	0-16700 mA	28A/1250µs	310 x 60 x 45 mm	189,95 €
862161	■ black	24V	200W	0-8300 mA	27A/650µs	310 x 60 x 45 mm	189,95 €



design example

MEANWELL POWER SUPPLIES ELG/HLG-SERIES

- aluminium housing
- suitable for indoor and outdoor use
- flicker free
- short-circuit proof and overload protection
- overheat control
- dimmable via 0-10V / 1-10V

item	colour	voltage	power	electricity	max. inrush current	dimensions L x W x H	price
872117	□ silver coloured	ELG	48V 75W	0-1600mA	50A/350µs	180 x 63 x 36 mm	104,95 €
872120	□ silver coloured	ELG	48V 150W	0-3130mA	65A/550µs	219 x 63 x 36 mm	169,95 €
872123	□ silver coloured	ELG	48V 240W	0-5000mA	60A/510µs	244 x 71 x 38 mm	199,95 €
872126	□ silver coloured	HLG	48V 600W	0-12500mA	70A/1000µs	280 x 144 x 49 mm	499,95 €



POWER SUPPLIES

DC | CV
dimmable



DEKO-LIGHT POWER SUPPLIES LCP DALI

- plastic housing
- suitable for indoor use
- short-circuit proof and overload protection
- overheat control
- dimmable via DALI2 or DALI1, 10V / 1-10V or Touch-Dim via 230V Taster
- new Intelli-Push function [key combination synchronises all connected power supplies]



design example

item	colour	voltage	power	electricity	max. inrush current	dimensions L x W x H	price
862253	white	12V	40W	0-3400mA	10A/32µs	185 x 42,5 x 28,5 mm	99,95 €
862254	white	12V	75W	0-6250mA	22A/300µs	295 x 40 x 32 mm	129,95 €
862255	white	24V	40W	0-1700mA	10A/32µs	185 x 42,5 x 28,5 mm	99,95 €
862256	white	24V	75W	0-3125mA	22A/300µs	295 x 40 x 32 mm	129,95 €
862262	white	24V	150W	0-6250mA	38A/430µs	295 x 40 x 32 mm	169,95 € NEW
862263	white	24V	240W	0-10000mA	60A/430µs	360 x 40 x 32 mm	219,95 € NEW



DEKO-LIGHT POWER SUPPLIES | DESIGN BASIC

- aluminium housing
- suitable for indoor use
- short-circuit proof and overload protection
- overheat control
- dimmable via DALI1, 0-10V, 1-10V or Intelli-Push [Touch-Dim via 230V-Taster]

item	colour	voltage	power	electricity	max. inrush current	dimensions L x W x H	price
862160	black	12V	200W	0-16700 mA	28A/1250µs	310 x 60 x 45 mm	189,95 €
862161	black	24V	200W	0-8300 mA	27A/650µs	310 x 60 x 45 mm	189,95 €



POWER SUPPLIES

DC | CV
dimmable



design example

MEANWELL POWER SUPPLIES ELG-DALI

- aluminium housing
- suitable for indoor and outdoor use
- flicker free
- short-circuit proof and overload protection
- overheat control
- dimmable via DALI1

item	colour	voltage	power	electricity	max. inrush current	dimensions L x W x H	price
872118	□ silver coloured	48V	75W	0-1600mA	50A/350µs	180 x 63 x 36 mm	119,95 €
872121	□ silver coloured	48V	150W	0-3130mA	65A/550µs	219 x 63 x 36 mm	179,95 €
872124	□ silver coloured	48V	240W	0-5000mA	60A/510µs	244 x 71 x 38 mm	199,95 €



POWER SUPPLIES

DC | CV
dimmable

MEANWELL POWER SUPPLIES PWM KNX

- plastic housing
- suitable for indoor use
- flicker free
- short-circuit proof and overload protection
- overheat control
- dimmable via KNX-Bus



design example

item	colour	voltage	power	electricity	max. inrush current	dimensions L x W x H	price
872109	■ black	12V	60W	0-5000mA	50A/270µs	150 x 53 x 35 mm	159,95 €
872110	■ black	12V	120W	0-10000mA	60A/520µs	191 x 63 x 38 mm	209,95 €
872111	■ black	12V	200W	0-16600mA	70A/520µs	195 x 68 x 40 mm	244,95 €
872112	■ black	24V	60W	0-2500mA	50A/270µs	150 x 53 x 35 mm	159,95 €
872113	■ black	24V	120W	0-5000mA	60A/520µs	191 x 63 x 38 mm	209,95 €
872114	■ black	24V	200W	0-8300mA	70A/520µs	195 x 68 x 40 mm	244,95 €
872115	■ black	48V	200W	0-4160mA	70A/520µs	195 x 68 x 40 mm	244,95 €



MEANWELL POWER SUPPLIES PWM CASAMBI

- plastic housing
- suitable for indoor use
- flicker free
- short-circuit proof and overload protection
- overheat control
- dimmable via CASAMBI-App



design example

item	colour	voltage	power	electricity	max. inrush current	dimensions L x W x H	price
862249	■ black	12V	60W	0-5000mA	50A/270µs	150 x 53 x 35 mm	259,95 €
862250	■ black	12V	120W	0-10000mA	60A/520µs	191 x 63 x 38 mm	299,95 €
862251	■ black	24V	60W	0-2500mA	50A/270µs	150 x 53 x 35 mm	259,95 €
862252	■ black	24V	120W	0-5000mA	60A/520µs	191 x 63 x 38 mm	299,95 €



POWER SUPPLIES

DC | CV
dimmable

DEKO-LIGHT POWER SUPPLIES HV DMX 2 IN 1

Easy to install and compact DMX unit. A powerful 3 channel dimmer and a 135 Watt power supply are combined in one housing. This makes installation quick and easy. Controllable with all 3 channel control panels and DMX Controllers.

- aluminium housing
- suitable for indoor use
- short-circuit proof and overload protection
- supported DMX 512
- dimmable from 0 - 100%
- flicker free
- with integrated 3-channel DMX dimmer



item	colour	voltage	power	electricity	max. inrush current	dimensions L x W x H	price
843274	■ black	12V	135W	0-11250 mA	23A/320µs	196 x 75 x 40 mm	169,95 €
843275	■ black	24V	0-5630 mA	23A/320µs	196 x 75 x 40 mm	169,95 €	

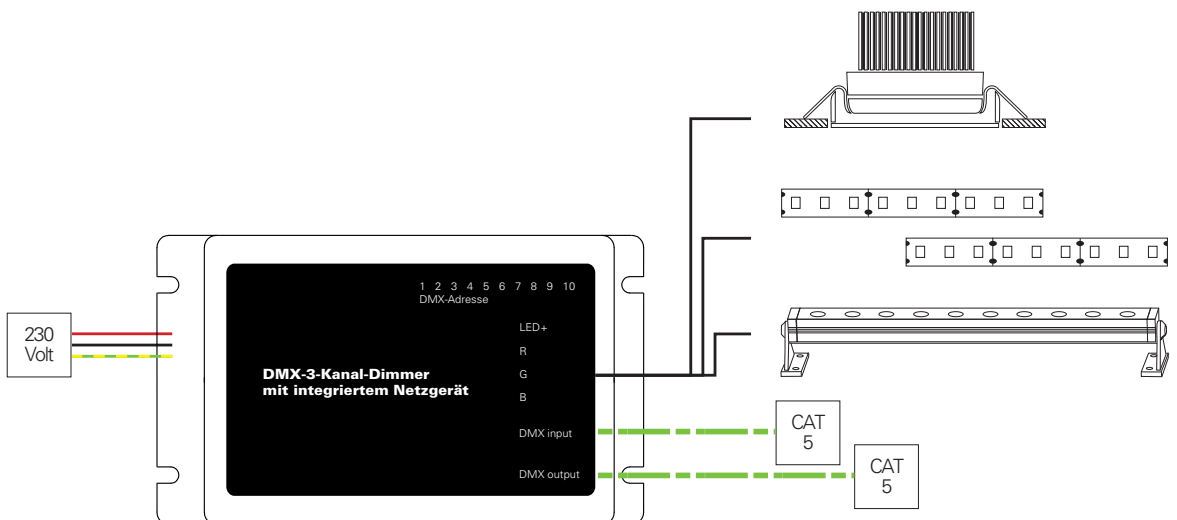

electr. data			dimmmable via					usage / design			electrical limit values			power supply	
current strength	power	voltage	leading edge / cut-off	touch dimmer [push]	DALI	KNX	CASAMBI-APP	indoor	outdoor	design	capacitive load	max. quantity per automatic circuit breaker	item number	page	
350 mA	1,1-4,0 W	3-12V						x	x	mini	14.32pF	B10A=17, B16A=28, C10A=37, C16A=59	872026	743	
350 mA	2,1-4,0 W	6-12V	x					x	x	mini	10.00nF	B10A=35, B16A=56, C10A=74, C16A=118	872132	746	
350 mA	0,7-6,0 W	2-18V						x		flat	40.44nF	B10A=17, B16A=28, C10A=37, C16A=59	872628	744	
350 mA	3,2-8,0 W	9-23V						x		round	200uF	B10A=17, B16A=28, C10A=37, C16A=59	862212	743	
350 mA	3,9-9,0 W	11-26V	x					x		basic		B10A=17, B16A=28, C10A=37, C16A=59	862202	747	
350 mA	6,0-10,0 W	17-29V						x		mini		B10A=57, B16A=92, C10A=57, C16A=92	862239	744	
350 mA	6,3-12,0 W	18-35V	x					x		basic	20,65pF	B10A=17, B16A=28, C10A=37, C16A=59	862203	747	
350 mA	0,7-12,0 W	2-35V						x		flat	194,0uF	B10A=11, B16A=18, C10A=24, C16A=39	862223	744	
350 mA	6,3-12,0 W	18-37V	x					x	x	octo	190uF	B10A=35, B16A=56, C10A=74, C16A=118	862235	747	
350 mA	0,7-18,0 W	2-52V						x		basic	147nF	B10A=17, B16A=28, C10A=37, C16A=59	180512	745	
350 mA	9,8-20,0 W	28-57V	x					x		basic		B10A=11, B16A=18, C10A=24, C16A=39	862204	747	
350 mA	0,7-20,0 W	2-57V						x		flat	195uF	B10A=11, B16A=18, C10A=24, C16A=39	862224	744	
450 mA	9,9-19,0 W	22-42V	x					x		quick		B10A=11, B16A=18, C10A=24, C16A=39	862257	748	
500 mA	1,0-4,0 W	2-8V						x	x	mini	19.8pF	B10A=17, B16A=28, C10A=37, C16A=59	872065	743	
500 mA	2,0-4,0 W	4-8V	x					x	x	mini	4.75nF	B10A=35, B16A=56, C10A=74, C16A=118	872014	746	
500 mA	1,0-6,0 W	2-12V						x		flat	38.48nF	B10A=17, B16A=28, C10A=37, C16A=59	862130	744	
500 mA	3,0-8,0 W	6-16V						x		round	62.96nF	B10A=11, B16A=18, C10A=24, C16A=39	862128	743	
500 mA	1,0-12,0 W	2-24V						x		flat	298uF	B10A=11, B16A=18, C10A=24, C16A=39	862225	744	
500 mA	6,5-10,0 W	13-20V						x		mini		B10A=57, B16A=92, C10A=57, C16A=92	862238	744	
500 mA	6,0-12,0 W	12-24V	x					x	x	octo	186uF	B10A=35, B16A=56, C10A=74, C16A=118	862236	747	
500 mA	1,0-18,0 W	2-38V						x		basic	147nF	B10A=17, B16A=28, C10A=37, C16A=59	180513	745	
500 mA	1,0-20,0 W	2-40V						x		flat	292uF	B10A=11, B16A=18, C10A=24, C16A=39	862226	744	
500 mA	10,0-20,0 W	20-40V	x					x		basic		B10A=11, B16A=18, C10A=24, C16A=39	862205	747	
500 mA	15,0-30,0 W	30-60V						x		basic	366nF	B10A=11, B16A=18, C10A=24, C16A=39	862196	745	
500 mA	20,0-40,0 W	40-80V						x		basic	356nF	B10A=8, B16A=14, C10A=18, C16A=29	862197	745	
500 mA	20,0-40,0 W	40-80V	x					x		basic	29.84nF	B10A=35, B16A=56, C10A=35, C16A=56	862136	747	

electr. data			dimmable via					usage / design			electrical limit values			power supply	
current strength	power	voltage	leading edge / cut-off	touch dimmer [push]	DALI	KNX	CASAMBI-APP	indoor	outdoor	design	capacitive load	max. quantity per automatic circuit breaker	item number	page	
700 mA	1,7-4,0 W	2-6V						x	x	mini	82pF	B10A=70, B16A=112, C10A=140, C16A=224	872131	743	
700 mA	2,0-4,0 W	2,5-6V	x					x	x	mini	10nF	B10A=35, B16A=56, C10A=74, C16A=118	872134	746	
700 mA	1,4-6,0 W	2-9V						x		flat	40.44nF	B10A=17, B16A=28, C10A=37, C16A=59	862048	744	
700 mA	4,2-8,0 W	6-12V						x		round	46.24nF	B10A=11, B16A=18, C10A=24, C16A=39	862129	743	
700 mA	1,4-12,0 W	2-17V						x		flat	427uF	B10A=11, B16A=18, C10A=24, C16A=39	862227	744	
700 mA	7,0- 12,0 W	10-17V	x					x	x	octo	188uF	B10A=35, B16A=56, C10A=74, C16A=118	862237	747	
700 mA	1,4-18,0 W	2-26V						x		basic	147nF	B10A=17, B16A=28, C10A=37, C16A=59	180514	745	
700 mA	1,4-20,0 W	2-29V						x		flat	295uF	B10A=11, B16A=18, C10A=24, C16A=39	862228	744	
700 mA	9,8-20,0 W	14-28V	x					x		basic		B10A=11, B16A=18, C10A=24, C16A=39	862207	747	
700 mA	9,1-30,0 W	13-43V						x		basic		B10A=11, B16A=18, C10A=24, C16A=39	862198	745	
700 mA	20,3-35,0 W	29-57V						x		basic	359,3nF	B10A=8, B16A=14, C10A=18, C16A=29	862199	745	
700 mA	19,6-40,0 W	28-56V	x					x		basic		B10A=35, B16A=56, C10A=35, C16A=56	862208	747	
900mA	19,8-40,0 W	22-44V						x		basic	13.5pF	B10A=8, B16A=14, C10A=18, C16A=29	862157	745	
900mA	19,8-40,0 W	22-44V	x					x		basic	30nF	B10A=35, B16A=56, C10A=35, C16A=56	862264	747	
1050 mA	9,8-22,0 W	9-20V	x					x		basic	40.72pF	B10A=11, B16A=18, C10A=24, C16A=39	872647	747	
1050 mA	9,5-90,0 W	9-28V						x		basic	27.9nF	B10A=35, B16A=56, C10A=35, C16A=56	862133	745	
1050 mA	20,0-40,0 W	19-38V						x		basic		B10A=8, B16A=14, C10A=18, C16A=29	862201	745	
1050 mA	20,0-40,0 W	19-38V	x					x		basic		B10A=35, B16A=56, C10A=35, C16A=56	862209	747	
1050 mA	23,5-45,0 W	22-43V	x					x		basic	33,46nF	B10A=35, B16A=56, C10A=35, C16A=56	862210	747	
1050 mA	23,1-45,0 W	22-43V	x					x		quick	33,46nF	B10A=35, B16A=56, C10A=35, C16A=56	862258	748	
1300 mA	26,0-50,0 W	20-39V	x					x		basic		B10A=35, B16A=56, C10A=35, C16A=56	862211	747	
1400 mA	19,6-40,0 W	14-28V	x					x		basic	20.8nF	B10A=35, B16A=56, C10A=35, C16A=56	862138	747	
1500 mA	40,0-60,0 W	27-42V	x					x		quick		B10A=25, B16A=41, C10A=25, C16A=41	862259	748	

power supplies design

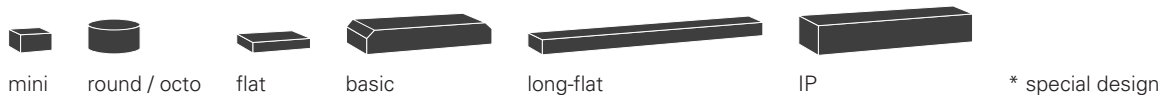

electr. data			dimmable via					usage / design			electrical limit values			power supply	
current strength	power	voltage	leading edge / cut-off	touch dimmer [push]	DALI	KNX	CASAMBI-APP	indoor	outdoor design	capacitive load	max. quantity per automatic circuit breaker	item number	page		
MULTI*	3,2-20,0 W	9-40V	x					x	basic		B10A=46, B16A=74, C10A=93, C16A=149	862141	749		
MULTI*	3,2-12,0 W	15-54V		x	x			x	basic		B10A=23, B16A=37, C10A=46, C16A=74	862190	751		
MULTI*	5,0-25,0 W	20-60V		x	x			x	basic		B10A=23, B16A=37, C10A=46, C16A=74	862191	751		
MULTI*	8,75-45,0 W	21-70V		x	x			x	basic		B10A=12, B16A=20, C10A=25, C16A=40	862192	751		
MULTI*	14,7-45,0 W	14-43V		x	x			x	basic		B10A=12, B16A=20, C10A=25, C16A=40	862193	751		
MULTI*	26,3-75,5 W	25-71V		x	x			x	basic		B10A=3, B16A=5, C10A=6, C16A=10	862194	751		
MULTI*	2,1-25,2 W	6-54V		x	x			x	*		B10A=16, B16A=26, C10A=27, C16A=44	862246	752		
MULTI*	0,70 - 42,00 W	2-100V		x	x			x	*		B10A=16, B16A=26, C10A=27, C16A=44	862247	752		
MULTI*	1,0-60,3 W	2-90V		x	x			x	*		B10A=15, B16A=25, C10A=20, C16A=32	862248	752		
MULTI*	2,1-25,2 W	6-54V		x		x		x	*		B10A=16, B16A=26, C10A=27, C16A=44	862174	753		
MULTI*	0,7-42,0 W	2-100V		x		x		x	*		B10A=16, B16A=26, C10A=27, C16A=44	862175	753		
MULTI*	1,0-60,3 W	2-90V		x		x		x	*		B10A=15, B16A=25, C10A=20, C16A=32	862176	753		
MULTI*	2,1-25,2 W	6-54V		x			x	x	*		B10A=16, B16A=26, C10A=27, C16A=44	862243	754		
MULTI*	0,7-42,0 W	2-100V		x			x	x	*		B10A=16, B16A=26, C10A=27, C16A=44	862244	754		
MULTI*	1,0-60,3 W	2-90V		x			x	x	*		B10A=15, B16A=25, C10A=20, C16A=32	862245	754		

* Due to the large number of possible settings, please refer to the detailed technical data on the specified product page.

TIPS AND TRICKS FOR CURRENT-STABLE POWER SUPPLIES

In contrast to voltage-stable power supplies [CV], current-stable power supply units, often abbreviated to CC [constant current], the output current is stable. This important factors that must be taken into focus during planning and installation.

- Do not connect LEDs to CC power supply units below voltage, as this can damage them and cause them to fail after a short period of operation.
- if possible: 1 luminaire = 1 power supply
- if necessary: operate max. 2 luminaires in a series connection on one power supply unit. However, the voltage range and the power of the power supply must be checked carefully.

Netzgerätedaten prüfen! Check driver data!

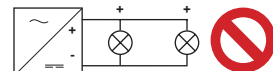
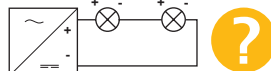
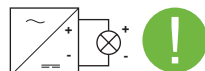

Installationshinweis für Netzgerät stromstabil [CC]: LED nicht unter Spannung anschließen!
installation instruction for power supply constant current [CC]: Don't connect LED under voltage!

POWER SUPPLIES

DC | CC
not dimmable

IP

DEKO-LIGHT POWER SUPPLIES | DESIGN MINI

- plastic housing
- suitable for indoor and outdoor use
- short-circuit proof and overload protection



item	colour	electricity	power	voltage	max. inrush current	dimensions L x W x H	price
872026	■ black	350mA	1,10-4,00W	3-12V	10A/300µs	38 x 27 x 21 mm	12,95 €
872065	■ black	500mA	1,00-4,00W	2-8V	10A/300µs	38 x 27 x 21 mm	12,95 €
872131	■ black	700mA	1,70-4,00W	2-6V	10A/100µs	38 x 27 x 21 mm	12,95 €



DEKO-LIGHT POWER SUPPLIES | DESIGN ROUND

- plastic housing
- suitable for indoor use
- short-circuit proof and overload protection



item	colour	electricity	power	voltage	max. inrush current	dimensions L x W x H	price
862212	■ black	350mA	3,20-8,00W	9-23V	10A/300µs	53 x 22 mm	20,95 €
862128	■ black	500mA	3,00-8,00W	6-16V	8A/300µs	53 x 22 mm	20,95 €
862129	■ black	700mA	4,20-8,00W	6-12V	8A/300µs	53 x 22 mm	20,95 €



POWER SUPPLIES

DC | CC
not dimmable

HEP POWER SUPPLIES G5S10W

- plastic housing
- suitable for indoor use
- flicker free
- short-circuit proof and overload protection



item	colour	electricity	power	voltage	max. inrush current	dimensions L x W x H	price
862239	<input type="checkbox"/> white	350mA	6,0-10,0W	17 - 29V	4,7A/30µs	58 x 39 x 20 mm	26,95 €
862238	<input type="checkbox"/> white	500mA	6,5-10,0W	13 - 20V	4,7A/30µs	58 x 39 x 20 mm	26,95 €



design example

DEKO-LIGHT POWER SUPPLIES | DESIGN FLAT

- plastic housing
- suitable for indoor use
- flicker free
- short-circuit proof and overload protection

item	colour	electricity	power	voltage	max. inrush current	dimensions L x W x H	price
872628	<input checked="" type="checkbox"/> black	350mA	0,70-6,00W	2-18V	10A/300µs	98 x 46 x 11 mm	17,95 €
862223	<input checked="" type="checkbox"/> black	350mA	0,70-12,00W	2-35V	10A/100µs	128 x 50 x 13 mm	24,95 €
862224	<input checked="" type="checkbox"/> black	350mA	0,70-20,00W	2-57V	10A/100µs	154 x 50 x 14 mm	28,95 € NEW
862130	<input checked="" type="checkbox"/> black	500mA	1,00-6,00W	2-12V	10A/300µs	98 x 46 x 11 mm	17,95 €
862225	<input checked="" type="checkbox"/> black	500mA	1,00-12,00W	2-24V	10A/100µs	128 x 50 x 13 mm	24,95 €
862226	<input checked="" type="checkbox"/> black	500mA	1,00-20,00W	2-40V	10A/100µs	154 x 50 x 14 mm	28,95 € NEW
862048	<input checked="" type="checkbox"/> black	700mA	1,40-6,00W	2-9V	10A/300µs	98 x 46 x 11 mm	17,95 €
862227	<input checked="" type="checkbox"/> black	700mA	1,40-12,00W	2-17V	10A/100µs	128 x 50 x 14 mm	24,95 € NEW
862228	<input checked="" type="checkbox"/> black	700mA	1,40-20,00W	2-29V	10A/100µs	128 x 50 x 14 mm	28,95 € NEW



POWER SUPPLIES

DC | CC

not dimmable



design example

DEKO-LIGHT POWER SUPPLIES | DESIGN BASIC

- plastic housing
- suitable for indoor use
- flicker free
- short-circuit proof and overload protection

item	colour	electricity	power	voltage	max. inrush current	dimensions L x W x H	price
180512	■ black	350mA	0,70-18,00W	2-52V	10A/300µs	115 x 45 x 21 mm	23,95 €
180513	■ black	500mA	1,00-18,00W	2-38V	10A/300µs	115 x 45 x 21 mm	23,95 €
862196	■ black	500mA	15,00-30,00W	30-60V	8A/300µs	127 x 43 x 28 mm	26,95 €
862197	■ black	500mA	20,00-40,00W	40-80V	20A/300µs	127 x 43 x 28 mm	29,95 €
180514	■ black	700mA	1,40-18,00W	2-26V	10A/300µs	115 x 45 x 21 mm	23,95 €
862198	■ black	700mA	9,10-30,00W	13-43V	8A/300µs	142 x 50 x 24 mm	26,95 €
862199	■ black	700mA	20,30-40,00W	29-57V	20A/300µs	127 x 43 x 28 mm	29,95 €
862157	■ black	900mA	19,80-40,00 W	22-44V	20A/300µs	127 x 43 x 28 mm	29,95 €
862133	■ black	1050mA	9,50-30,00W	9-28V	5A/300µs	142 x 50 x 24 mm	26,95 €
862201	■ black	1050mA	12,60-40,00W	12-38V	20A/300µs	142 x 50 x 24 mm	29,95 €





DEKO-LIGHT POWER SUPPLIES | DESIGN MINI

- plastic housing
- suitable for indoor and outdoor use
- short-circuit proof and overload protection
- dimmable with compatible [C-capable] trailing or leading edge phase dimmers

item	colour	electricity	power	voltage	max. inrush current	dimensions L x W x H	price
872132	■ black	350mA	2,10-4,00W	6-12V	5A/100µs	50 x 31 x 21 mm	19,95 €
872014	■ black	500mA	2,00-4,00W	4-8V	5A/300µs	50 x 27 x 21 mm	19,95 €
872134	■ black	700mA	2,00-4,00W	2,5-6V	5A/100µs	50 x 31 x 21 mm	19,95 €



POWER SUPPLIES

DC | CC
dimnable

IP

DEKO-LIGHT POWER SUPPLIES | DESIGN OCTO

- plastic housing
- suitable for indoor and outdoor use
- short-circuit proof and overload protection
- dimmable with compatible [C-capable] phase cut-off dimmers



item	colour	electricity	power	voltage	max. inrush current	dimensions L x W x H	price
862235	■ black	350mA	6,30-12,00W	18-37V	5A/100µs	50 x 48 x 24 mm	29,95 €
862236	■ black	500mA	6,00-12,00W	12-24V	5A/100µs	50 x 48 x 24 mm	29,95 €
862237	■ black	700mA	7,00-12,00W	10-17V	5A/100µs	50 x 48 x 24 mm	29,95 €



DEKO-LIGHT POWER SUPPLIES | DESIGN BASIC

- plastic housing
- suitable for indoor use
- short-circuit proof and overload protection
- overheat control
- dimmable with compatible [C-capable] phase cut-off dimmers



design example

item	colour	electricity	power	voltage	max. inrush current	dimensions L x W x H	price
862202	■ black	350mA	3,90-9,00W	11- 26V	10A/300µs	115 x 39 x 22 mm	28,95 €
862203	■ black	350mA	6,30-12,00W	18-35V	10A/300µs	115 x 39 x 22 mm	36,95 €
862204	■ black	350mA	9,80-20,00W	28,57V	15A/300µs	127 x 44 x 28 mm	39,95 €
862205	■ black	500mA	10,00-20,00W	20-40V	15A/300µs	127 x 44 x 28 mm	39,95 €
862136	■ black	500mA	20,00-40,00W	40-80V	5A/300µs	166 x 52 x 24 mm	46,95 €
862207	■ black	700mA	9,80-20,00W	14-28V	15A/300µs	127 x 44 x 28 mm	39,95 €
862208	■ black	700mA	19,60-40,00W	28-56V	5A/300µs	166 x 52 x 24 mm	46,95 €
862264	■ black	900mA	19,60-40,00W	22-44V	5A/100µs	166 x 52 x 25 mm	46,95 € NEW
872647	■ black	1050mA	9,80-22,00W	9-20V	15A/300µs	127 x 44 x 28 mm	39,95 €
862209	■ black	1050mA	20,00-40,00W	19-38V	5A/300µs	166 x 52 x 25 mm	46,95 €
862210	■ black	1050mA	23,50-45,00W	22-43V	5A/100µs	166 x 52 x 25 mm	49,95 €
862211	■ black	1300mA	26,00-50,00W	20-39V	5A/300µs	166 x 52 x 25 mm	51,95 €
862138	■ black	1400mA	19,60-40,00W	14-28V	5A/300µs	166 x 52 x 24 mm	46,95 €



POWER SUPPLIES

DC | CC
dimnable



design example



quick installation
with through-wiring

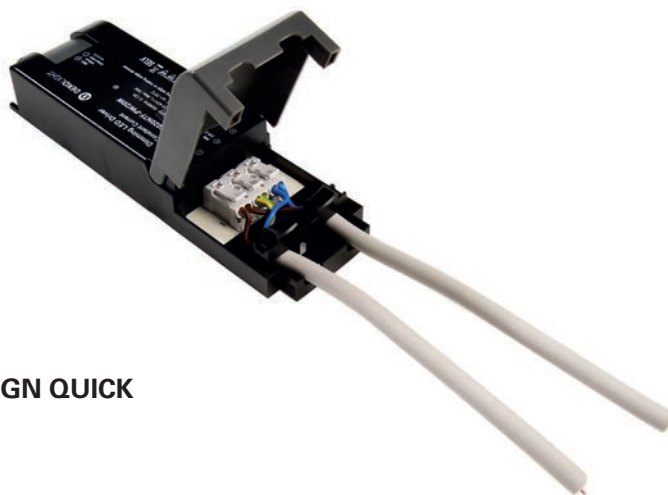

DEKO-LIGHT POWER SUPPLIES | DESIGN QUICK

- plastic housing
- suitable for indoor use
- flicker free
- short-circuit proof and overload protection
- overheat control
- particularly easy and quick to install
due to integrated 3-pole through-wiring
- no additional installation material necessary
- dimmable with compatible [C-capable]
phase cut-off dimmers

item	colour	electricity	power	voltage	max. inrush current	dimensions L x W x H	price
862257	■ black	450mA	9,90-19,00W	22-42V	5A/300µs	208 x 60 x 32 mm	36,95 €
862258	■ black	1050mA	23,10-45,00W	22-43V	5A/300µs	208 x 60 x 32 mm	46,95 €
862259	■ black	1500mA	40,00-63,00W	27-42V	5A/300µs	208 x 60 x 32 mm	56,95 €



POWER SUPPLIES

DC | CC
dimmissible



HEP POWER SUPPLY G6LT15W350LR-Z

- dimmable via phase cut-off
- suitable for indoor use

item	colour	electricity	power	voltage	max. inrush current	dimensions L x W x H	price
862266	<input type="checkbox"/> white	350mA	9,1-15,0W	26 - 43V	10A/40µs	85 x 40,4 x 22 mm	32,95 €



DEKO-LIGHT POWER SUPPLY | BASIC MULTI-CURRENT

- plastic housing
- suitable for indoor use
- flicker free
- short-circuit proof and overload protection
- current range adjustable
- dimmable with compatible [C-capable] trailing or leading edge dimmers



item	colour	electricity	power	voltage	max. inrush current	dimensions L x W x H	price
862141	<input type="checkbox"/> white	350mA	3,20 - 14,00W	9-40V	15A/90µs	150 x 43 x 28 mm	41,95 €
		400mA	3,60 - 16,00W	9-40V			
		450mA	4,00 - 18,00W	9-40V			
		500mA	4,50 - 20,00W	9-40V			
		550mA	5,00 - 19,80W	9-36V			
		600mA	5,40 - 19,80W	9-33V			
		650mA	5,90 - 19,50W	9-30V			
		700mA	6,30 - 19,60W	9-28V			



POWER SUPPLIES

DC | CC
dimmable



DEKO-LIGHT MULTI-CURRENT DALI 2.0 POWER SUPPLIES DALI 2 IE-12D | IE-25D | IE-45D | IE-45HD | IE-75D

A must for every electrician: the new MULTI-CC DALI 2.0 power supplies from DEKO-LIGHT are a real all-purpose weapon for universal use.

They can be controlled via DALI1 or DALI2 [fully upward and downward compatible] or via Intelli-Push. In this case, the multi-current-power supplies do not require any additional control components and are controlled by means of cost-effective 230V standard push-buttons. With the new Intelli-Push function, they also have a pioneering synchronisation option if one of the connected power supplies no longer runs synchronously with the others.

In addition, the MULTI-power supplies can also be operated undimmed without control as a reliable and universal power supplier. With a total of five models, the new DALI series covers a CC current range from 180mA to 1600mA and power ratings from 4 to 75 watts.

- plastic housing
- compact housing design
- suitable for indoor use
- flicker free
- short-circuit proof and overload protection
- overheat control
- current range adjustable via DIP switch
- DALI 2 BUS ready according to IEC 62386
- fully downward compatible with DALI 1
- dimming range: 1-100%
- dimmable via DALI or touch dimmer function [push] new Intelli-Push function [key combination synchronises all connected power supplies]
- can also be operated without control as universal power supply unit universal power supply [no dimming function]
- 3.2-75 watts and 37 CC variants in only 3 different housing sizes



design example 114 x 52 x 24 mm



design example 133 x 71 x 24 mm



design example 159 x 79 x 30 mm

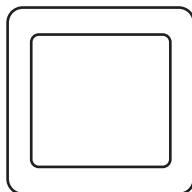

controllable with DALI2, DALI1 or by touch dim using a regular 230V push-button

TOUCH-DIM / INTELLI-PUSH VIA 230V PUSH BUTTON WITHOUT ADDITIONAL CONTROL:

press button short switch lamp on/off

press button long dim lamp bright/dark/bright

press button for 15 seconds

All connected power supplies are synchronised to the same brightness.

item	colour	electricity	power	voltage	max. inrush current	dimensions L x W x H	price
862190	■ black	180mA	3,20 - 9,80W	18 - 54V	30A/300µs	114 x 52 x 24 mm	59,95 €
		230mA	4,00 - 12,00W	18 - 52V			
		260mA	4,00 - 12,00W	15 - 46V			
		300mA	4,50 - 12,00W	15 - 42V			
		350mA	4,20 - 12,00W	15 - 34V			
		400mA	6,00 - 12,00W	15 - 30V			
		450mA	5,40 - 12,00W	15 - 27V			
		500mA	7,50 - 12,00W	15 - 24V			
862191	■ black	260mA	5,00 - 15,50W	20 - 60V	30A/300µs	114 x 52 x 24 mm	64,95 €
		350mA	7,00 - 20,00W	20 - 60V			
		400mA	8,00 - 24,00W	20 - 60V			
		450mA	9,00 - 25,00W	20 - 55V			
		500mA	10,00 - 25,00W	20 - 50V			
		550mA	11,00 - 25,00W	20 - 45V			
		600mA	12,00 - 25,00W	20 - 42V			
		700mA	14,00 - 25,00W	20 - 36V			
862192	■ black	350mA	8,75 - 24,50W	25 - 70V	55A/100µs	133 x 71 x 24 mm	69,95 €
		500mA	12,50 - 35,00W	25 - 70V			
		600mA	15,00 - 42,00W	25 - 70V			
		700mA	17,50 - 45,00W	25 - 64V			
		800mA	20,00 - 45,00W	25 - 56V			
		900mA	22,50 - 45,00W	25 - 50V			
		1050mA	25,00 - 45,00W	21 - 43V			
		862193	■ black	1050mA			
1150mA	16,10 - 45,00W			14 - 39V			
1200mA	16,80 - 45,00W			14 - 38V			
1300mA	18,20 - 45,00W			14 - 35V			
1400mA	19,60 - 45,00W			14 - 32V			
1500mA	21,00 - 45,00W			14 - 30V			
1600mA	22,40 - 45,00W			14 - 28V			
862194	■ black			1050mA	26,30 - 74,50W	25 - 71V	55A/300µs
		1150mA	28,80 - 74,80W	25 - 65V			
		1200mA	30,00 - 74,40W	25 - 62V			
		1300mA	32,50 - 75,50W	25 - 58V			
		1400mA	35,00 - 74,20W	25 - 53V			
		1500mA	37,50 - 75,00W	25 - 50V			
		1600mA	40,00 - 75,20W	25 - 47V			



POWER SUPPLIES

DC | CC
dimnable



design example

MEANWELL LCM DALI-POWER SUPPLIES 25DA2 | 40DA2 | 60DA2

- current range via DIP switch adjustable
- Dali Bus ready according to IEC 62386
- dimmable via DALI2, DALI1 or Intelli-Push [Touch-Dim via 230V push-button]
- master/slave operation of several power supplies via Sync cable [accessories]
- suitable for indoor use

item	colour	electricity	power	voltage	max. inrush current	dimensions L x W x H	price
862246	<input type="checkbox"/> white	350mA	2,10 - 18,90W	6 - 54V	20A/260µs	105 x 68 x 23 mm	89,95 €
		500mA	3,00 - 25,20W	6 - 50V			
		600mA	3,60 - 25,20W	6 - 42V			
		700mA	4,20 - 25,20W	6 - 36V			
		900mA	5,40 - 25,20W	6 - 28V			
		1050mA	6,30 - 25,20W	6 - 24V			
862247	<input type="checkbox"/> white	350mA	0,70 - 35,00W	2 - 100V	20A/260µs	124 x 82 x 23 mm	104,95 €
		500mA	1,00 - 40,00W	2 - 80V			
		600mA	1,20 - 40,00W	2 - 67V			
		700mA	1,40 - 40,00W	2 - 57V			
		900mA	1,80 - 40,50W	2 - 45V			
		1050mA	2,10 - 42,00W	2 - 40V			
862248	<input type="checkbox"/> white	500mA	1,00 - 45,00W	2 - 90V	20A/260µs	124 x 82 x 23 mm	109,95 €
		600mA	1,20 - 54,00W	2 - 90V			
		700mA	1,40 - 60,30W	2 - 86V			
		900mA	1,80 - 60,30W	2 - 67V			
		1050mA	2,10 - 59,90W	2 - 57V			
		1400mA	2,80 - 59,00W	2 - 42V			



POWER SUPPLIES

DC | CC
dimmable



design example

MEANWELL LCM KNX-POWER SUPPLIES 25KN | 40KN | 60KN

- current range via DIP switch adjustable
- KNX/EIB BUS eady
- suitable for indoor use
- flicker free

item	colour	electricity	power	voltage	max. inrush current	dimensions L x W x H	price
862174	☐ white	350 mA	2,10 - 18,90W	6 - 54V	20A/260µs	105 x 68 x 23 mm	134,95 €
		500 mA	3,00 - 25,20W	6 - 50V			
		600 mA	3,60 - 25,20W	6 - 42V			
		700 mA	4,20 - 25,20W	6 - 36V			
		900 mA	5,40 - 25,20W	6 - 28V			
		1050 mA	6,30 - 25,20W	6 - 24V			
862175	☐ white	350 mA	0,70 - 35,00W	2 - 100V	20A/260µs	124 x 82 x 23 mm	144,95 €
		500 mA	1,00 - 40,00W	2 - 80V			
		600 mA	1,20 - 40,00W	2 - 67V			
		700 mA	1,40 - 40,00W	2 - 57V			
		900 mA	1,80 - 40,50W	2 - 45V			
		1050 mA	2,10 - 42,00W	2 - 40V			
862176	☐ white	500 mA	1,00 - 45,00W	2 - 90V	20A/260µs	124 x 82 x 23 mm	154,95 €
		600 mA	1,20 - 54,00W	2 - 90V			
		700 mA	1,40 - 60,30W	2 - 86V			
		900 mA	1,80 - 60,30W	2 - 67V			
		1050 mA	2,10 - 59,90W	2 - 57V			
		1400 mA	2,80 - 59,00W	2 - 42V			



POWER SUPPLIES

DC | CC
dimnable



design example

MEANWELL LCM CASAMBI POWER SUPPLIES 25BLE | 40BLE | 60BLE

- suitable for indoor use
- current range via DIP switch adjustable
- dimmable via CASAMBI app or touch dim via 230V push-button
- flicker free

item	colour	electricity	power	voltage	max. inrush current	dimensions L x W x H	price
862243	<input type="checkbox"/> white	350mA	2,10 - 18,90W	6 - 54V	20A/260µs	105 x 68 x 23 mm	239,95 €
		500mA	3,00 - 25,20W	6 - 50V			
		600mA	3,60 - 25,20W	6 - 42V			
		700mA	4,20 - 25,20W	6 - 36V			
		900mA	5,40 - 25,20W	6 - 28V			
		1050mA	6,30 - 25,20W	6 - 24V			
862244	<input type="checkbox"/> white	350mA	0,70 - 35,00W	2 - 100V	20A/260µs	124 x 82 x 23 mm	249,95 €
		500mA	1,00 - 40,00W	2 - 80V			
		600mA	1,20 - 40,00W	2 - 67V			
		700mA	1,40 - 40,00W	2 - 57V			
		900mA	1,80 - 40,50W	2 - 45V			
		1050mA	2,10 - 42,00W	2 - 40V			
862245	<input type="checkbox"/> white	500mA	1,00 - 45,00W	2 - 90V	20A/260µs	124 x 82 x 23 mm	259,95 €
		600mA	1,20 - 54,00W	2 - 90V			
		700mA	1,40 - 60,30W	2 - 86V			
		900mA	1,80 - 60,30W	2 - 67V			
		1050mA	2,10 - 59,90W	2 - 57V			
		1400mA	2,80 - 59,00W	2 - 42V			



POWER SUPPLIES

DC | CC
dimnable



TCI POWER SUPPLY JOLLY MD PUSH

- suitable for indoor use
- constant current [CC] or constant voltage [CV] adjustable via DIP switch
- dimmable via leading edge or push [Touch dim via 230V push button]
- master/slave operation of several power supplies via sync cable [accessories]

item	colour	operating mode	electricity	power	voltage	dimensions L x W x H	price
561201	<input type="checkbox"/> white	stromkonstant	350mA	0,70 - 16,50W	2 - 47V	165 x 48 x 35 mm	94,95 €
			500mA	1,00 - 23,50W	2 - 47V		
			550mA	1,10 - 25,90W	2 - 47V		
			700mA	1,40 - 32,00W	2 - 46V		
			750mA	1,50 - 32,00W	2 - 43V		
		spannungskonstant	12V	10W			
			24V	20W			
			28V	22W			



Zubehör

- 561202** SYNC cable for synchronisation of max. 10 power supply units with push function, length 150 cm **10,95 €**

electr. data		dimmable via				usage / design			electrical limit values		power supply	
current strength	power	electronic power supply	conventional transformer	leading edge	leading edge / cut-off	indoor	outdoor design	capacitive load	max. quantity per automatic circuit breaker	item number	page	
electronic transformers:												
12V	0,0-70,0 W	x			x	x	basic	97.79nF	B10A=8, B16A=14, C10A=18, C16A=29	180515	756	
12V	0,0-105,0 W	x			x	x	basic	139.58nF	B10A=5, B16A=9, C10A=12, C16A=19	180529	756	

wound transformers:

12V	11,5-20,0 W		x	x		x	*			000097	757
12V	34,5-60,0 W		x	x		x	*			000099	757
12V	43,5-75,0 W		x	x		x	x	*		000140	757
12V	60,5-105,0 W		x	x		x		*		000107	757
12V	86,5-150,0 W		x	x		x		*		000103	757
12V	86,5-150,0 W		x	x		x	x	*		000141	757
12V	115,0-200,0 W		x	x		x		*		000104	757
12V	172,5-300,0 W		x	x		x		*		000106	757
12V	172,5-300,0 W		x	x		x	x	*		000142	757
12V	287,5-500,0 W		x	x		x		*		000109	757

DEKO-LIGHT TRANSFORMER ULTRA HALOGEN 12 VOLT / AC

- electronic transformer [12V]
 - lamp protection voltage
 - plastic housing
 - suitable for indoor use
 - flicker free
 - short-circuit proof and overload protection
 - dimmable with leading edge phase dimmers [C-capable]
- 180515:** 0-70W halogen or 0-50W / max. 6x LED
180529: 0-105W halogen or 0-50W / max. 6x LED



design example

item	colour	voltage	power	electricity	max. inrush current	dimensions L x W x H	price
180515	■ black	12V	0 - 70W	0-5830 mA	20A/300µs	115 x 45 x 28 mm	17,95 €
180529	■ black	12V	0 - 105W	0-8750mA	30A/300µs	115 x 45 x 28 mm	22,95 €



POWER SUPPLIES

AC | CV
dimmissible

ABN TRANSFORMER 12 VOLT / AC

- conventional transformer
- lamp protection voltage
- dimmable via leading edge
- suitable for indoor use



design example

item	colour	voltage	power	dimensions L x W x H	price
000097	<input type="checkbox"/> white	20VA	11,50 - 20,00 W	82 x 56 x 50 mm	79,95 €
000099	<input type="checkbox"/> white	60VA	34,50 - 60,00 W	100 x 70 x 61 mm	109,95 €
000107	<input type="checkbox"/> white	105VA	60,50 - 105,00 W	107 x 78 x 66 mm	139,95 €
000103	<input type="checkbox"/> white	150VA	86,50 - 150,00 W	130 x 88 x 78 mm	159,95 €
000104	<input type="checkbox"/> white	200VA	115,00 - 200,00 W	130 x 88 x 88 mm	189,95 €
000106	<input type="checkbox"/> white	300VA	172,50 - 300,00 W	130 x 88 x 103 mm	209,95 €
000109	<input type="checkbox"/> white	500VA	287,50 - 500,00 W	177 x 107 x 130 mm	369,95 €



optional accessories transformer housing Pyra

000110	for 105 W	19,95 €
000111	for 150-300 W	19,95 €



ABN TRANSFORMER 12 VOLT / AC

- conventional transformer
- lamp protection voltage
- 1,9 m connection cable [primary]
- 0,5 m connection cable [secondary]
- dimmable via leading edge
- suitable for indoor and outdoor use



design example

item	colour	voltage	power	dimensions L x W x H	price
000140	<input checked="" type="checkbox"/> black	75VA	43,50 - 75,00 W	108 x 81 x 66 mm	149,95 €
000141	<input checked="" type="checkbox"/> black	150VA	86,50 - 150,00 W	130 x 93 x 78 mm	189,95 €
000142	<input checked="" type="checkbox"/> black	300VA	172,50 - 300,00 W	130 x 93 x 102 mm	249,95 €





CONTROLLER

- 762 RF-smart
- 774 RF control
- 778 Casambi Bluetooth
- 780 quick finder | DMX controller
- 781 quick finder | DMX dimmer
- 782 DMX wall controller
- 786 DMX controller
- 788 DMX dimmer
- 792 DALI PWM dimmer



RF-smart | Starter-Set
page 763

RF-smart | TRIAC-Dimmer
page 764

RF-smart | LED-Dimmer
page 765

RF-smart | Repeater
page 766



RF-smart | remote control
page 767

RF-smart | remote control
page 768

RF-smart | wall-mounted
remote control
page 769

RF-smart | illuminant
from page 770



RF-smart | floodlight
page 772

RF-smart | Spot
page 773

RF controller | 1 - 4 channel
from page 774

RF touchpanel | 2 - 4 channel
from page 776



Casambi Bluetooth
page 778

Casambi Bluetooth
page 778

Casambi Bluetooth
page 779

Casambi Bluetooth
page 779



DMX wall controller
page 782

DMX wall controller
page 782

DMX wall controller
page 783

DMX wall controller
page 784



DMX wall controller
page 784

DMX wall controller
page 785

DMX controller
page 786



DMX controller
page 787



DMX dimmer
page 788



DMX dimmer
page 788



DMX dimmer
page 789



DMX dimmer
page 789



DMX dimmer
page 790



DMX dimmer
page 791



DALI PWM dimmer
page 792



DALI PWM dimmer
page 792



DALI PWM dimmer
page 793



DALI PWM dimmer
page 793

controller

DEKO-LIGHT RF-SMART

We are pleased to introduce you to the new multifunctional RF-smart control system from DEKO-LIGHT. In addition to controlling and dimming devices with 230V mains voltage, LED dimmers for controlling LED strips with 1-5 channels [single/CCT/RGB/RGBW/RGBW+CCT] and a voltage of 12V to 48V are available. For outdoor use, you will also find dimmers in IP67 version. The system is perfectly complemented by matching luminaires with integrated RF module, such as outdoor floodlights, an outdoor spotlight with a particularly narrow beam angle and LED retrofit bulbs for common bulb sockets.

In the most basic configuration level, you control RF-smart components with the corresponding RF radio remote controls. Here, not only are starter remote controls available with functions and a control zone, but also battery-operated wall-mounted remote controls with up to eight individually controllable zones are available. This selection already offers you and your customers a multitude of possibilities.

The integrated RF autosync function for important functions - such as the range extension of RF remote controls or the synchronisation of running automatic programmes when using several dimmers - obviates the need for additional installation work and costs.

But there is more: most RF-smart components are also equipped with a Zigbee 3.0-compatible radio module that can be used to realise a wide range of smart home functions [compatible with the most important smart home systems, including Amazon Echo [Alexa], Google Assistant, Tuya and more]. In this way, you are free to choose whether to control the connected RF-smart components via smartphone, tablet and/or your voice. The Zigbee 3.0 radio standard offers comprehensive compatibility with a wide range of apps from different providers for an almost limitless variety of applications. Speaking of limitless: thanks to controlling via app and respective functions, you can control connected RF-smart luminaires worldwide without installing additional components!

Thanks to sophisticated technology, installation and initial commissioning are extremely simple. Directly after the electrical connection, all necessary function tests of the connected luminaires or devices can be carried out. The two dimmer modules are seamlessly complemented by integrated push inputs. With these isolated push-button inputs, you can in most cases use an existing electrical installation, including the existing switch system, to switch the connected RF-smart dimmers on/off and, if necessary, dim them using standard push-buttons.

RF-smart represents a simple, super-fast installation and commissioning and at the same time offers a maximum of convenience in controlling.





DEKO-LIGHT RF-SMART STARTER-SET 1 230V TRIAC DIMMER + RF-REMOTE CONTROL

- set consisting of:
1x TRIAC DIMMER 230V [843503]
1x RF-REMOTE CONTROL Single/CCT white [843508]
- operation with 2x AAA batteries [not included in delivery]
- for technical data see item codes mentioned above

item	colour	controlling of	price
843500	<input checked="" type="checkbox"/> <input type="checkbox"/> black + white	230V components	99,95 €



DEKO-LIGHT RF-SMART STARTER-SET 2 LED DIMMER + RF-REMOTE CONTROL SINGLE/CCT

- set consisting of:
1x LED DIMMER 5-IN-1 [843505]
1x RF-REMOTE CONTROL Single/CCT white [843508]
- operation with 2x AAA batteries [not included in delivery]
- for technical data see item codes mentioned above

item	colour	controlling of	price
843501	<input checked="" type="checkbox"/> <input type="checkbox"/> black + white	Single/CCT	99,95 €



DEKO-LIGHT RF-SMART STARTER-SET 3 LED DIMMER + RF-REMOTE CONTROL RGB/RGBW/RGB+CCT

- set consisting of:
1x LED DIMMER 5-IN-1 [843505]
1x RF-REMOTE CONTROL Single/CCT white [843510]
- operation with 2x AAA batteries [not included in delivery]
- for technical data see item codes mentioned above

item	colour	controlling of	price
843502	<input checked="" type="checkbox"/> <input type="checkbox"/> black + white	RGB/RGBW/RGB+CCT	99,95 €





DEKO-LIGHT RF-SMART TRIAC DIMMER 230V

- plastic
- Last-State-Memory [last setting is stored]
- adjustable function mode [dimmer or on/off switch]
- adjustment function for minimum brightness
- Push-Dim connection [push-button for on/off + brightness]
- Intelli-Push function
- remote control synchronisation when operating several RF-smart dimmers [repeater function]
- controllable with RF-smart radio remote control [2.4GHz, range approx. 30m, not included]
- controllable with all Zigbee 3.0 compatible controllers / apps e.g. Amazon Echo [Alexa], Google Assistant, Tuya [corresponding gateway required, outdoor range up to 100m]
- controller dimensions L x W x H: 25 x 49 x 49 mm
- power: max. 300W / 1,36A



item	colour	controlling of	price
843503	■ black	230V components	69,95 €



DEKO-LIGHT RF-SMART OUTDOOR TRIAC DIMMER 230V

- plastic
- Last-State-Memory [last setting is stored]
- adjustable function mode [dimmer or on/off switch]
- adjustment function for minimum brightness
- remote control synchronisation when operating several RF-smart dimmers [repeater function]
- controllable with RF-smart radio remote control [2.4GHz, range approx. 30m, not included]
- controllable with all Zigbee 3.0 compatible controllers / apps e.g. Amazon Echo [Alexa], Google Assistant, Tuya [corresponding gateway required, outdoor range up to 100m]
- controller dimensions L x W x H: 170 x 155 x 65 mm
- power: max. 300W / 1,36A
- outdoor installation distributor IP67 with up to 4 cable entries from 4-14mm as well as 2 blind plugs



item	colour	controlling of	price
843504	■ black	230V components	89,95 €



DEKO-LIGHT RF-SMART LED DIMMER 5-IN-1, 5 CHANNEL SINGLE/CCT/RGB/RGBW/RGB+CCT

- plastic
- 16 million colours and colour temperature adjustable [depending on the selected channel mode]
- 8 automatic programmes pre-installed
- programme speed adjustable via remote control
- flicker-free [picture/video recordings]
- Last-State-Memory [last setting is stored]
- Push-Dim connection [push-button for on/off + brightness]
- Intelli-Push function
- programme and remote control synchronisation when operating several several RF-smart dimmers [master/slave and repeater function]
- controllable with RF-smart radio remote control [2.4GHz, range approx. 30m, not included]
- controllable with all Zigbee 3.0 compatible controllers / apps e.g. Amazon Echo [Alexa], Google Assistant, Tuya [corresponding gateway required, outdoor range up to 100m]
- controller dimensions L x W x H: 23 x 47 x 120 mm
- power: max. 20A/controller, max. 10A/channel
- 12V= 240W, 24V= 480W, 48V= 960W

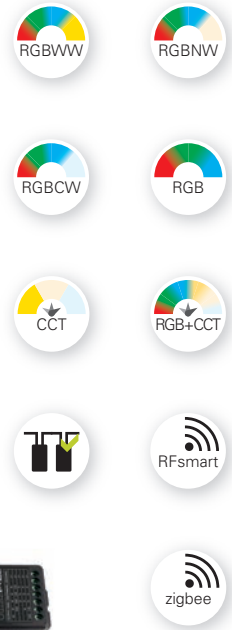

item	colour	controlling of	price
843505	■ black	Single/CCT /RGB/RGBW/RGB+CCT	69,95 €



DEKO-LIGHT RF-SMART OUTDOOR LED DIMMER 5-IN-1, 5 CHANNEL SINGLE/CCT/RGB/RGBW/RGB+CCT

- plastic
- 16 million colours and colour temperature adjustable [depending on the selected channel mode]
- 8 automatic programmes pre-installed
- programme speed adjustable via remote control
- flicker-free [picture/video recordings]
- Last-State-Memory [last setting is stored]
- programme and remote control synchronisation when operating several several RF-smart dimmers [master/slave and repeater function]
- controllable with RF-smart radio remote control [2.4GHz, range approx. 30m, not included]
- controllable with all Zigbee 3.0 compatible controllers / apps e.g. Amazon Echo [Alexa], Google Assistant, Tuya [corresponding gateway required, outdoor range up to 100m]
- controller dimensions L x W x H: 30 x 88 x 200 mm
- power: max. 20A/controller, max. 10A/channel
- 12V= 240W, 24V= 480W, 48V= 960W
- 20 cm connection cable pre-assembled



item	colour	controlling of	price
843506	■ black	Single/CCT /RGB/RGBW/RGB+CCT	109,95 €





DEKO-LIGHT RF-SMART RF-REPEATER

- plastic
- extends the range of an RF remote control by approx. 30m
- supports remote control and programme synchronisation when operating several RF-smart components [repeater function]
- supports up to 12 RF remote controls
- also suitable for outdoor use
- incl. 1m connection cable with IP44 plug
- controller dimensions L x W x H: 103 x 34 x 34 mm

item	colour	price
843507	<input type="checkbox"/> white	34,95 €



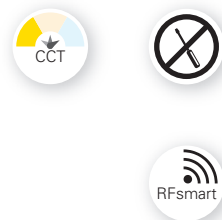

DEKO-LIGHT RF-SMART RF-REMOTE CONTROL SINGLE/CCT

- plastic
- hand-held remote control
- incl. magnetic holder for additional wall mounting
- dimensions L x Ø: 24 x 70 mm
- brightness dimmable
- colour temperature adjustable if necessary
- RF radio remote control [2.4GHz, range approx. 30m]
- battery operation 3V [2x AAA not included in delivery]

item	colour	controlling of	differently controllable zones	price
843508	<input type="checkbox"/> white	Single/CCT	1	38,95 €
843509	<input checked="" type="checkbox"/> black	Single/CCT	1	38,95 €

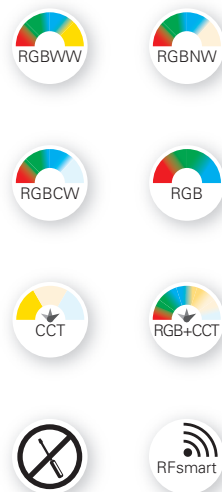

DEKO-LIGHT RF-SMART RF-REMOTE CONTROL RGB/RGBW/RGB+CCT

- plastic
- hand-held remote control
- incl. magnetic holder for additional wall mounting
- dimensions L x Ø: 24 x 70 mm
- brightness dimmable
- colours and, if necessary, saturation and colour temperature adjustable
- automatic programmes selectable
- colour temperature adjustable if necessary
- RF radio remote control [2.4GHz, range approx. 30m]
- battery operation 3V [2x AAA not included in delivery]

item	colour	controlling of	differently controllable zones	price
843510	<input type="checkbox"/> white	RGB/RGBW/RGB+CCT	1	38,95 €
843511	<input checked="" type="checkbox"/> black	RGB/RGBW/RGB+CCT	1	38,95 €





**DEKO-LIGHT RF-SMART
RF-REMOTE CONTROL 8 ZONES
SINGLE/CCT/RGB/RGBW/RGB+CCT**

- plastic
- hand-held remote control
- dimensions L x W x H: 19 x 153 x 47 mm
- brightness, if necessary, colours, saturation, colour temperature adjustable
- automatic programmes and speed selectable
- RF-smart dimmer and/or luminaires can be divided into up to 8 differently controllable zones
- RF radio remote control [2.4GHz, range approx. 30m]
- battery operation 3V [2x AAA not included in delivery]
- incl. wall mounting bracket

item	colour	controlling of	differently controllable zones	price
843512	■ black	Single/CCT/RGB/RGBW/RGB+CCT	up to 8	49,95 €





DEKO-LIGHT RF-SMART RF-WALL REMOTE CONTROL 4 ZONES SINGLE/CCT/RGB/RGBW/RGB+CCT

- plastic
- wall remote control [surface-mounted]
- dimensions L x W x H: 16 x 86 x 86 mm
- brightness, if necessary, colours, saturation, colour temperature adjustable
- automatic programmes and speed selectable
- RF-smart dimmer and/or luminaires can be divided into up to 4 differently controllable zones
- RF radio remote control [2.4GHz, range approx. 30m]
- battery operation 3V [2x AAA not included in delivery]

item	colour	controlling of	differently controllable zones	price
843513	<input type="checkbox"/> white	Single/CCT/RGB/RGBW/RGB+CCT	up to 4	69,95 €



DEKO-LIGHT RF-SMART RF-WALL REMOTE CONTROL 8 ZONES SINGLE/CCT/RGB/RGBW/RGB+CCT

- plastic
- wall remote control [surface-mounted]
- dimensions L x W x H: 20 x 106 x 146 mm
- brightness, if necessary, colours, saturation, colour temperature adjustable
- automatic programmes and speed selectable
- RF-smart dimmer and/or luminaires can be divided into up to 8 differently controllable zones
- delayed auto-off function with 60s time delay
- RF radio remote control [2.4GHz, range approx. 30m]
- battery operation 3V [2x AAA not included in delivery]

item	colour	controlling of	differently controllable zones	price
843514	<input type="checkbox"/> white	Single/CCT/RGB/RGBW/RGB+CCT	up to 8	109,95 €





DEKO-LIGHT RF-SMART ILLUMINANT GU10 RGB+CCT RF CONTROLLABLE

- plastic
- dimensions L x Ø: 57 x 50 mm
- brightness and colour saturation dimmable
- 16 million colours and colour temperature adjustable
- 18 automatic programmes preinstalled
- programme and remote control synchronisation when operating several RF-smart lamps [repeater function]
- controllable with RF-smart radio remote controls [2.4GHz, range approx. 30m, not included in delivery]
- controllable with RF remote control only [no Zigbee functionality]

item	colour	colour temp.	light current	power	equivalent to	EEL energy consumption	price
843515	<input type="checkbox"/> white	RGB WW CW 2700-6000 K	300 lm	4 W	35 W	F 4 kWh/1000h	34,95 €





DEKO-LIGHT RF-SMART ILLUMINANT E27 A60 RGB+CCT RF CONTROLLABLE

- plastic
- dimensions L x Ø: 100 x 57 mm
- brightness and colour saturation dimmable
- 16 million colours and colour temperature adjustable
- 18 automatic programmes preinstalled
- programme and remote control synchronisation when operating several RF-smart lamps [repeater function]
- controllable with RF-smart radio remote controls [2.4GHz, range approx. 30m, not included in delivery]
- controllable with RF remote control only [no Zigbee functionality]

item	colour	colour temp.	light current	power	equivalent to	beam angle	EEL energy consumption	price
843516	<input type="checkbox"/> white	<input checked="" type="checkbox"/> RGB <input checked="" type="checkbox"/> WW <input checked="" type="checkbox"/> CW 2700-6000 K	550 lm	6 W	55 W	220°	F 6 kWh/1000h	34,95 €



DEKO-LIGHT RF-SMART ILLUMINANT E27 MAX RGB+CCT RF CONTROLLABLE

- plastic
- dimensions L x Ø: 140 x 74 mm
- brightness and colour saturation dimmable
- 16 million colours and colour temperature adjustable
- 18 automatic programmes preinstalled
- programme and remote control synchronisation when operating several RF-smart lamps [repeater function]
- controllable with RF-smart radio remote controls [2.4GHz, range approx. 30m, not included in delivery]
- controllable with RF remote control only [no Zigbee functionality]

item	colour	colour temp.	light current	power	equivalent to	beam angle	EEL energy consumption	price
843517	<input type="checkbox"/> white	<input checked="" type="checkbox"/> RGB <input checked="" type="checkbox"/> WW <input checked="" type="checkbox"/> CW 2700-6000 K	1100 lm	12 W	100 W	220°	F 12 kWh/1000h	64,95 €





DEKO-LIGHT RF-SMART FLOOD RGB+CCT RF + ZIGBEE

- aluminium diecast / plastic
- brightness and colour saturation dimmable
- 16 million colours and colour temperature adjustable
- 18 automatic programmes preinstalled
- programme and remote control synchronisation when operating several RF-smart lamps [repeater function]
- controllable with RF-smart radio remote controls [2.4GHz, range approx. 30m, not included in delivery]
- controllable with all Zigbee 3.0 compatible controllers / apps such as Amazon Echo [Alexa], Google Assistant, Tuya [corresponding gateway required, outdoor range up to 100m]
- incl. 1.5 m connection cable with IP44 plug

item	colour	colour temp.	light current	power	dimensions L x W x H	EEI	price
843518	■ anthracite	RGB 2700-6000 K	3300 lm	30 W	167 x 40 x 227 mm	E	249,95 €
843519	■ anthracite	RGB 2700-6000 K	4800 lm	50 W	220 x 48 x 311 mm	F	349,95 €
843520	■ anthracite	RGB 2700-6000 K	10000 lm	100 W	295 x 60 x 403 mm	F	549,95 €



accessories

930659 wall bracket / display arm | black **59,95 €**

matching remote controls and further RF-smart components on page 763-771

suitable mounting accessories for outdoor use from page 827

suitable energy distributors/plug-in socket towers on page 453



With the kind support of Loxone Lichtinstallation Eurotec-Ibiza@fotoeichhorn



DEKO-LIGHT RF-SMART SPOT RGB+CCT RF + ZIGBEE

- aluminium diecast / plastic
- brightness and colour saturation dimmable
- 16 million colours and colour temperature adjustable
- 18 automatic programmes preinstalled
- programme and remote control synchronisation when operating several RF-smart lamps [repeater function]
- controllable with RF-smart radio remote controls [2.4GHz, range approx. 30m, not included in delivery]
- controllable with all Zigbee 3.0 compatible controllers / apps such as Amazon Echo [Alexa], Google Assistant, Tuya [corresponding gateway required, outdoor range up to 100m]
- incl. 1.5 m connection cable with IP44 plug
- incl. ground spike
- very narrow beam angle, ideal for column lighting or similar

item	colour	colour temp.	light current	power	dimensions L x W x H	price
843521	■ anthracite	2700-6000 K	1700 lm	25 W	170 x 65 x 180 mm	239,95 €

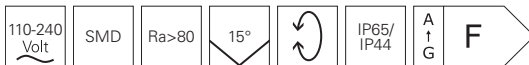

accessories

930659 wall bracket / display arm | black **59,95 €**

matching remote controls and further RF-smart components on page 763-771
 suitable mounting accessories for outdoor use from page 827
 suitable energy distributors/plug-in socket towers on page 453



DEKO-LIGHT RF

With the DEKO-LIGHT RF system, which has been proven for many years and is easy to install, the radio remote controls can be used to control corresponding receiver systems within a radius of approx. 20 metres. The possibility of connecting only one radio remote control to several controllers also extends the system in a simple way.

Attention: A 100% synchronous control [programme sequence, colour change] of several controller boxes with only one radio remote control can only be realised by a connection via network cable [master-slave function]. The memory function saves the last setting after a power failure. Please note that the components of the RF system are not compatible with the new RF-smart system.



DEKO-LIGHT RF CONTROLLER SET RF SINGLE

- for controlling 1-channel LED stripes
- set consists of:
controller, remote control and wall bracket
- dimmable
- 4 effect programs
- adjustable programme speed
- max. 8 remote controls / 2 touch panels per system range
- memory function
- master/slave function
- dimensions controller L x W x H: 115 x 57 x 25 mm
- not compatible/combinable with RF-smart system
- max. 7,5A each channel
- power: 2x 90W [180W] at 12V DC,
2x 180W [360W] at 24V DC,
2x 360W [720W] at 48V DC

item	colour	price
843056	■ black	104,95 €

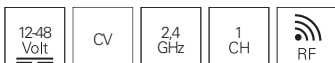

accessories for 843056

843064	controller	89,95 €
843014	remote control	32,95 €
843013	wall bracket	10,95 €



DEKO-LIGHT RF CONTROLLER SET RF WHITE

- for controlling WW/CW LED stripes
- set consists of:
controller, remote control and wall bracket
- WW oder CW dimmable as single colour
- 9 effect programs
- adjustable programme speed
- max. 8 remote controls / 2 touch panels per system range
- memory function
- master/slave function
- dimensions controller L x W x H: 115 x 57 x 25 mm
- not compatible/combinable with RF-smart system
- max. 7,5A each channel
- power: 2x 90W [180W] at 12V DC,
2x 180W [360W] at 24V DC,
2x 360W [720W] at 48V DC

item	colour	price
843057	■ black	109,95 €

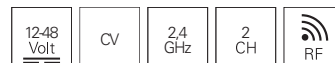

accessories for 843057

843065	controller	89,95 €
843015	remote control	32,95 €
843013	wall bracket	10,95 €
843019	touch panel	96,95 €

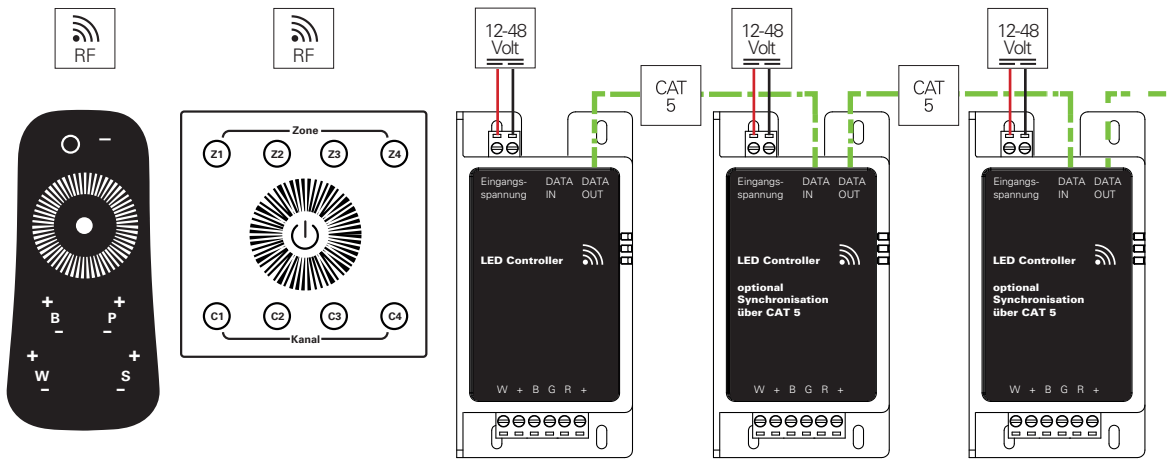

outputs for LED stripes/luminaires



DEKO-LIGHT RF CONTROLLER SET RF COLOR

- for controlling RGB LED stripes
- set consists of:
controller, remote control and wall bracket
- R/G/B dimmable as single colour
- 13 effect programs
- adjustable programme speed
- max. 8 remote controls / 2 touch panels
per system range
- memory function
- master/slave function
- dimensions controller L x W x H: 115 x 57 x 25 mm
- not compatible/combinable with RF-smart system
- max. 5,0A each channel
- power: 3x 60W [180W] at 12V DC,
3x 120W [360W] at 24V DC,
3x 240W [720W] at 48V DC

item	colour	price
843058	■ black	114,95 €

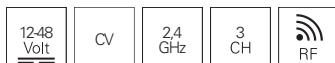

accessories for 843058

843066	controller	96,95 €
843016	remote control	32,95 €
843013	wall bracket	10,95 €
843020	touch panel	96,95 €

DEKO-LIGHT RF CONTROLLER SET RF COLOR & WHITE

- for controlling RGB + white LED stripes
- set consists of:
controller, remote control and wall bracket
- R/G/B + white dimmable as single colour
- 12 effect programs
- adjustable programme speed
- max. 8 remote controls / 2 touch panels
per system range
- memory function
- master/slave function
- dimensions controller L x W x H: 115 x 57 x 25 mm
- not compatible/combinable with RF-smart system
- max. 5,0A each channel
- power: 4x 45W [180W] at 12V DC,
4x 90W [360W] at 24V DC,
4x 180W [720W] at 48V DC

item	colour	price
843059	■ black	119,95 €

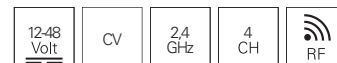

accessories for 843059

843067	controller	96,95 €
843017	remote control	32,95 €
843013	wall bracket	10,95 €
843021	touch panel	96,95 €

DEKO-LIGHT TOUCH PANEL RF WITH 4-ZONE-FUNCTION

The respective receiving systems are controlled within a range of 20 m through the touch panel. The system can be expanded in a simple manner by connecting one single touch panel to several controller boxes. Note: A 100% synchronous controlling [program sequence, colour change] of several control boxes with one single remote control per

zone can be implemented only with an available network cable connection [Master-Slave function]. The memory effect saves the most recent setting after a power failure. The unit is mounted in a 68mm single device box.



DEKO-LIGHT WALL TOUCH PANEL RF WHITE

- control of the controller via radio, no additional control lines necessary
- for controlling WW/CW LED stripes / luminaires
- 4 zones
- independent dimming of individual zones
- all zones can be switched on/off together
- 9 effect programs
- adjustable programme speed
- memory function
- dimensions L x W x H: 86,5 x 86,5 x 31,1 mm
- not compatible/combinable with RF-smart system

item	colour	price
843019	<input type="checkbox"/> white	96,95 €

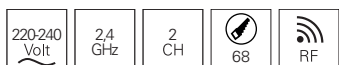

DEKO-LIGHT WALL TOUCH PANEL RF COLOR

- control of the controller via radio, no additional control lines necessary
- for controlling RGB LED stripes / luminaires
- 4 zones
- independent dimming of individual zones
- all zones can be switched on/off together
- 13 effect programs
- adjustable programme speed
- memory function
- dimensions L x W x H: 86,5 x 86,5 x 31,1 mm
- not compatible/combinable with RF-smart system

item	colour	price
843020	<input type="checkbox"/> white	96,95 €

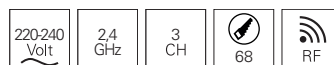

accessories for 843019

843065 controller **89,95 €**

accessories for 843020

843066 controller **96,95 €**

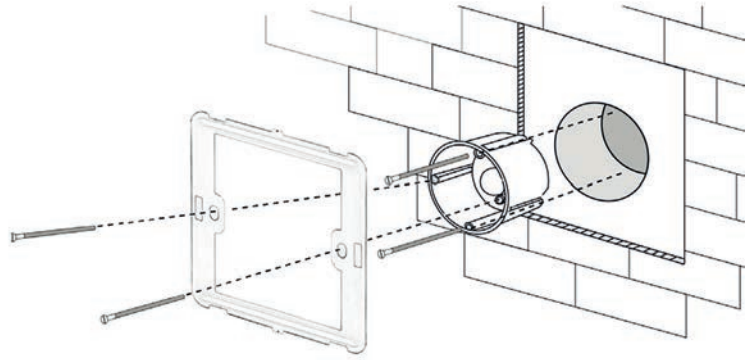

DEKO-LIGHT WALL TOUCH PANEL RF COLOR & WHITE

- control of the controller via radio,
no additional control lines necessary
- for controlling RGB + white LED stripes / luminaires
- 4 zones
- independent dimming of individual zones
- all zones can be switched on/off together
- 12 effect programs
- adjustable programme speed
- memory function
- dimensions L x W x H: 86,5 x 86,5 x 31,1 mm
- not compatible/combinable with RF-smart system

item	colour	price
843021	<input type="checkbox"/> white	96,95 €

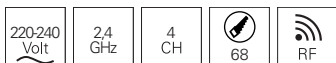

accessories for 843021

843067	controller	96,95 €
---------------	------------	----------------

SMART HOME CAN BE SO SIMPLE

Install the Casambi module in the distribution box, suspended ceiling or similar – install the app from the Playstore/iTunes, connect the module to your mobile phone and the app, set it up and off you go!

CASAMBI BLUETOOTH CBU-TED | 230V SWITCHING/DIMMING

With this module 230V components can be directly dimmed or switched [configuration via mobile app].

- suitable for R-loads [light bulb, high-voltage halogen]
- suitable for C-loads [dimmable high-voltage LED, electrical power supplies]
- power in switching operation: light bulb, high-voltage halogen, high-voltage LED, electrical ballasts: max. 150W
- power in dimming mode: dimmable high-voltage LED, electrical ballasts: max. 50W / max. 2 components
- dimensions L x W x H: 40,4 x 36,3 x 14 mm



item	colour	price
843008	<input type="checkbox"/> white	144,95 €



CASAMBI BLUETOOTH CBU-ASD | DALI/0-10V | 1-10V

The module generates either a DALI, 0-10V or 1-10V control signal with which 1 ballast/power supply or similar can be operated [configuration via mobile app].

- dimensions L x W x H: 56,5 x 35,8 x 22,3 mm

item	colour	price
843011	<input type="checkbox"/> white	149,95 €



CASAMBI BLUETOOTH CBU-PWM4 | LED 1-4 CHANNEL DIMMER

With this module you can control 12V/24V LED stripes, lamps etc. with 1-4 channels [WW, CW, WW-CW, RGB, RGBW], which can be controlled by PWM [configuration via mobile app].

- dimensions L x W x H: 72,6 x 30 x 18 mm
- power 144W at 24V, 72W at 12V

item	colour	price
843037	<input type="checkbox"/> white	179,95 €







CASAMBI BLUETOOTH WAND-CONTROLLER XPRESS

- Bluetooth-wall controller compatible with Casambi-System
- mounting with screws or adhesive pad
- independent mounting, as battery operated [3V button cell] and no cabling necessary
- setup and programming via Casambi-App
- plastic
- L x W x H: 90 x 90 x 12 mm

item	colour	price
843050	<input type="checkbox"/> white	399,95 €
843049	<input checked="" type="checkbox"/> black	399,95 €



DMX controller		max. number of zones	DMX channels per zone	1-channel-modus [single]	2-channel-modus [CW-WW]	3-channel-modus [RGB]	4-channel-modus [RGBW]	5-channel-modus [RGBW-A]	6-channel-modus [RGB-CW-WW-A]
843005 TC-2 	wall controller for dimming of 1-DMXchannel with 4 programmable keys	1	1	yes	-	-	-	-	-
843000 Art-4 RGB/RGBW 	controller can next to 4-channel RGBW also for 3-channel RGB components used become	1	3/4	-	-	yes	yes	-	-
843003 Art-9 RGB/RGBW 	controller can next to 4-channel RGBW also for 3-channel RGB components used become	1	3/4	-	-	yes	yes	-	-
843004 Touch 16CH Pro 	the 4 zones of the controller can be any be mixed [1- / 2- / 3- / 4-channel]	4	1-4	yes [zone-mix available]	yes [zonemix available]	yes [zonemix available]	yes [zonemix available]	-	-
861203 X-Fade-6 II 	simple wall controller for the simple and manual Dimming from up to 6 DMX channels	-	1-6	yes	manual regulati-on [max. 3x 2 CH]	manual regulati-on [max. 2x 3 CH]	manual regulati-on [max. 1x 4 CH]	-	-
843001 Touch 16C 	wall controller for controlling up to 16 DMX channels	4	1-4	yes [max. 16x 1 CH]	manual colour-setting [max. 8x 2 CH]	manual colour-setting [max. 4x 3 CH]	manual colour-setting [max. 4x 4 CH]	-	-
843046 LED EASY Operator 	comfotable controller with programmable keys, programs ideal for gastronomy, events and more comprehensive installations	4	1-6	yes [max. 4x 1 CH]	yes [max. 4x 2 CH]	yes [max. 4x 3 CH]	yes [max. 4x 4 CH]	yes [max. 4x 5 CH]	yes [max. 4x 6 CH]
843047 LED Color Chief 	top controller with programmable keys, programs and USB backup ideal for gastronomy, events and more comprehensive installations	8	1-6	yes [max. 8x 1 CH]	yes [max. 8x 2 CH]	yes [max. 8x 3 CH]	yes [max. 8x 4 CH]	yes [max. 8x 5 CH]	yes [max. 8x 6 CH]

DMX dimmer		available channel mode	compatible with 1-channel-controllers	compatible with 2-channel-controllers	compatible with 3-channel-controllers	compatible with 4-channel-controllers	compatible with 5-channel-controllers	compatible with 6-channel-controllers	flicker free
843336 LED Dimmer 2 	simple DMX dimmer with high PWM rate [deployment in areas, in those filmed will]	1/2	yes	yes	-	-	-	-	yes
843273 Dimmer R-DMX 3+1 	DMX dimmer with remote configuration possibility [R-DMX] especially for the events sector	3/4	-	-	yes	yes	-	-	-
843337 LED Dimmer 4 	simple DMX dimmer with high PWM rate [deployment in areas, in which will be filmed]	4	-	-	yes	yes	-	-	yes
843279 MULTI-LED Dimmer 	simple programming via display, multi-mode: DMX, auto programs, manual control without Controller	1/2/3/4	yes	yes	yes	yes	-	-	yes
843054 LED-Dimmer DMX für [CC] stromstabile luminaires 	DMX dimmer 24-50V, 4x60W, programming via display	1/2/3/4	yes	yes	yes	yes	yes [required two times]	yes [required two times]	yes



DEKO-LIGHT CONTROLLER TC-2

The TC-2 controller is a touch panel, allowing the storage and retrieval of up to 4 storage locations. Scenes and atmospheres are created quickly in a user-friendly manner with the aid of the intuitive controller. It suits both hotels and auditoriums, as well as the home and living space.

- touch interface
- optional DMX512 or analogous 0-10V
- fade time setting from 0.01 to 10s
- dimming steps 0-100%
- LED Display
- 4 storage locations
- DMX out / DC in / 0-10V out: connection terminals
- dimensions L x W x H: 86 x 86 x 15,3 mm

item	colour	price
843005	■ black	189,95 €

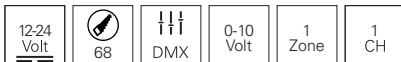

accessories

872128 power supply Mini 24V/4W **12,95 €**



DEKO-LIGHT X-FADE-6

The X-Fade 6 is a modern wall controller on the DMX basis for LED dimmers. Up to 6 faders can be directly controlled and connected to RGB dimmers. For example, 2 RGB stripes are addressed and also 6 single one-colour stripes can be controlled in 6 different zones. The X-Fade 6 is further used as a standard 6 channel DMX Controller, which enables the control of DMX dimmers or devices with up to 6 channels. Additionally, up to 6 different programs can be retrieved. Each program can contain up to 100 steps. Programs can also be controlled automatically. [A mounting box is required for the assembly of the controller.]

- incl. IR-remote control
- 6 programmable scenes
- fade time setting
- DMX out / DC in: connection terminals
- dimensions L x W x H: 86 x 86 x 16,3 mm

item	colour	price
861203	■ black	199,95 €



accessories

872128 power supply Mini 24V/4W **12,95 €**

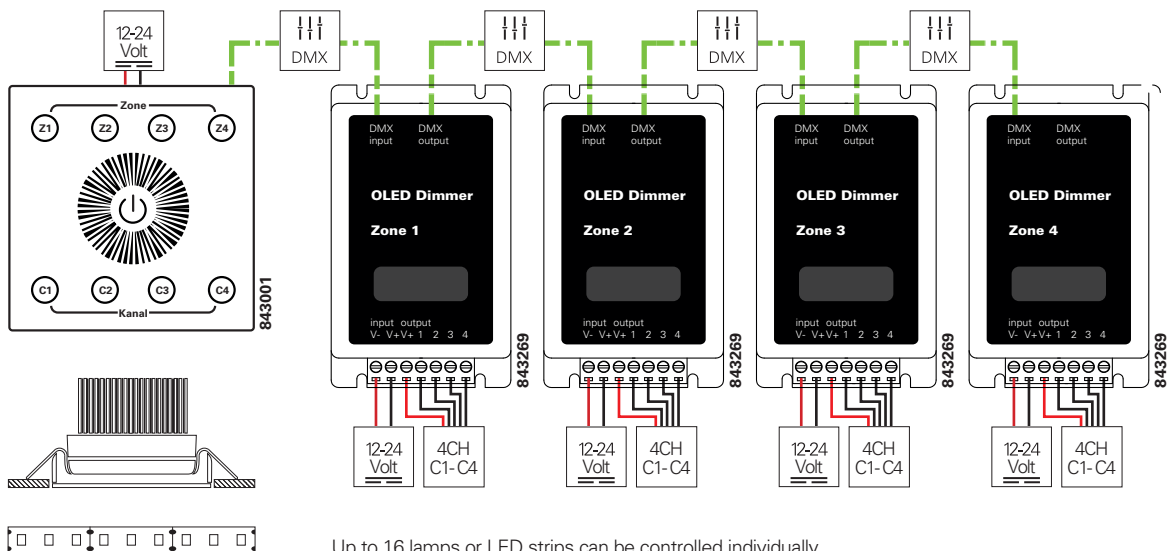

Up to 16 lamps or LED strips can be controlled individually.

DEKO-LIGHT LED DMX TOUCH 16C

The LED DMX TOUCH 16C is provided with 4 zones with 4 channels each. In total, 16 single channels are available. At the selection of one of the zones (Z1-Z4), the touchwheel controls all 4 channels of this zone. At the selection of one channel (C1-C4) in one zone, the touchwheel controls this selected channel. If neither a zone nor a channel is selected, the touchwheel controls all zones, including their channels. Please note that the controller was specifically designed for warm and/or cold white end devices. By its functions, it is only conditionally implemented for RGB or RGBW end devices.



- background illumination and touch signal tone optionally connectable
- memory function: the DMX Touch 16C memorizes the most recent brightness setting of all zones and channels
- DMX out: CAT5 [RJ45] opt. connection terminals
- dimensions L x W x H: 86 x 86 x 17,4 mm

item	colour	price
843001	■ black	119,95 €

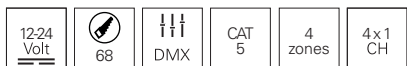

accessories

872128	power supply Mini 24V/4W	12,95 €
930697	Data cable RJ45 for connecting controller or further dimmers, length 2.0 m	3,95 €

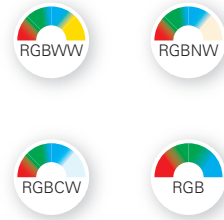
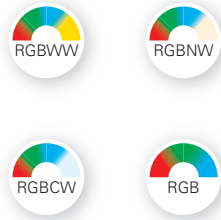

DEKO-LIGHT ART 4 | RGB/RGBW

The ART 4 controller is a touch panel for playing and editing colour programs, specifically for RGBW end devices. Up to 4 atmospheres and up to 4 scenes can be saved and retrieved. The ART-4 contains 4 function menus: Selection of integrated programs, colour, brightness, speed setting. Scenes and atmospheres are created in a quick and user-friendly manner. As a design element, the ART 4 controller is ideally suited in the environment and is an appropriate choice both for hotels and auditoriums and the home and living space.

- PWM out for the direct control of LED stripes
- control element and controller via touchwheel
- fade times of 0-4 seconds possible
- DMX out / DC in: connection terminals
- dimensions L x W x H: 86 x 86 x 15,3 mm
- integrated PWM dimmer 12/24V, 4 x 2A

DEKO-LIGHT ART 9 | RGB/RGBW

The ART 9 controller is a touch panel for playing and editing colour programs, specifically for RGBW end devices. Up to 9 atmospheres and up to 9 scenes can be saved and retrieved. The ART-4 contains 4 function menus: Selection of integrated programs, colour, brightness, speed setting. Scenes and atmospheres are created in a quick and user-friendly manner. As a design element, the ART 9 controller is ideally suited in the environment and is an appropriate choice both for hotels and auditoriums and the home and living space.

- PWM out for the direct control of LED stripes
- control element and controller via touchwheel
- fade time setting for switch on/off and colour change
- function memory and power failure protection
- DMX out / DC in: connection terminals
- dimensions L x W x H: 172 x 86 x 15,3 mm
- integrated PWM dimmer 12/24V, 4 x 2A

item	colour	price
843000	■ black	229,95 €



item	colour	price
843003	■ black	234,95 €



accessories

872128 power supply Mini 24V/4W **12,95 €**

accessories

872128 power supply Mini 24V/4W **12,95 €**

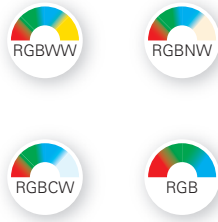

DEKO-LIGHT TOUCH 16CH PRO

The Touch 16CH Pro controller is a touch panel, allowing the storage and retrieval of up to 4 zones with 4 channels each. Scenes and atmospheres are created quickly in a userfriendly manner with the aid of the intuitive controller. It suits both hotels and auditoriums, as well as the home and living space. As a design element, the Touch 16Ch Pro is ideally implemented in the living space.

- colour mode for setting the colours in each individual zone
- program mode for the colour change and fader setting for each zone
- time mode for setting the start and end time of the programs
- 14 pre-installed or 8 auto-created programs can be assigned to one scene
- internal clock to switch the zones time-dependently with the saved programs
- DMX out / DC in: connection terminals
- dimensions L x W x H: 86 x 86 x 15,3 mm

item	colour	price
843004	 black	359,95 €



accessories

872128	power supply Mini 24V/4W	12,95 €
---------------	--------------------------	----------------



EUROLITE DMX-CONTROLLER LED COLOR CHIEF

The COLOR CHIEF is an innovative and easy to use DMX controller, which is optimally tailored to the needs and requirements of gastronomy, bars, event locations, event rooms, etc. . It is suitable for controlling e. g. LED stripes, lights, spotlights, light effects and all other components with 1-6 colours [WW, CW, WW-CW, RGB, RGBW, RGB-

WAUV] or up to 30 channels, which can be controlled with DMX via corresponding controller/dimmer. 24 different and directly selectable scene buttons allow access to previously stored lighting scenes or program sequences. The USB interface can be used to save the created programming to a USB memory stick and, if necessary, to restore it.

- easy control of LED stripes, lights, headlights or similar with 1-6 colors or simple lighting effects with up to 30 channels
- for up to 8 different device groups/zones
- fast and easy programming
- extensive, already pre-installed device library with many common applications
- additional devices can be easily added manually
- 8 colour effects directly selectable
- three additional channels are freely assignable per device [e.g. for special functions, movements, etc.]
- colour wheel selection
- 24 memory slots for permanently stored lighting moods
- USB port for data storage / restoration of programming

- clock control with programmed chases via music signal
- total dimming, fade time between individual scenes comfortably adjustable
- 3-pin XLR connector
- firmware-Update via USB
- operation as rack installation [19 "/ 3 height units] or desktop unit
- control: DMX / max. 240 channels
- power supply: power cable with power adapter [included]
- weight: 2,2 kg
- protection class: IP20
- connection power: 10 W
- dimensions L x W x H: 483 x 132 x 85 mm

item	colour	price
843047	■ black	469,95 €



accessories

882271	adapter DMX plug to CAT5	54,95 €
---------------	--------------------------	----------------

786 CONTROLLER | DMX controller

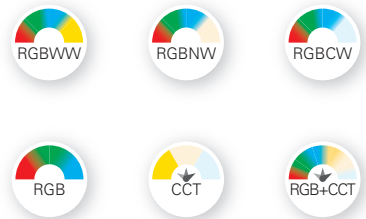

EUROLITE DMX-CONTROLLER LED EASY DELUXE

The LED EASY DELUXE is a very simple and intuitive DMX controller that can be used for a wide range of applications. No matter if commercial or private, wherever LED stripes, lights, spotlights with 1-6 colours [WWW, CW, WWW-CW, RGB,

RGBW, RGBW-A-UV] and DMX are controlled via corresponding controller/dimmer, this new DXM controller finds its application. It is very easy to directly select 12 different stored light moods/scenes using a rotary control.

- easy control of LED stripes, lamps, spotlights etc. with 1-6 colours
- for up to 4 different device groups/zones
- quick and easy commissioning thanks to pre-installed programs
- single DMX channels for red, green, blue, white, amber and UV
- 12 memory slots for permanently stored lighting moods
- 4 colour controls with 12 colours each
- 4 brightness controls
- function buttons for blackout, auto, music control and strobe effect
- fader for overall brightness, sequence and fade time
- 3-pin XLR connector
- operation as a tabletop device or built-in device
- control: DMX / max. 24 channels
- power supply: power cable with power adapter [included]
- weight: 1,2 kg
- protection class: IP20
- connection power: 10 W
- dimensions L x W x H: 260 x 140 x 65 mm

item	colour	price
843046	■ black	239,95 €

100-240 Volt	DMX	4 zones	16 CH
--------------	-----	---------	-------

accessories

882271	adapter DMX plug to CAT5	54,95 €
---------------	--------------------------	----------------



DEKO-LIGHT MULTI DIMMER 4 4 CHANNEL 3-IN-CONTROL / PWM DIMMER

- DMX control / mode
- automatic / program mode
- manual dimmer mode
- use as 1, 2, 3 or 4 channel dimmer
- 24 color change programs preset
- manual mode allows to dim the 4 channels on the fixture individually [manual color setting]
- flicker-free for video recording [2 kHz]
- master/slave function
- easy and user-friendly programming via 4-button control menu and display
- after power failure dimmer automatically shows last mode, program or colour setting
- DMX signal / master-slave pluggable via CAT5
- dimensions L x W x H: 116 x 57 x 26,8 mm
- max. 20A [4x 5A each channel]
- power: 4x 60W [240W] at 12V,
4x 120W [480W] at 24V,
4x 240W [960W] at 48V

item	colour	price
843279	■ black	114,95 €



accessories

930697	Data cable RJ45 for connecting controller or further dimmers, length 2.0 m	3,95 €
---------------	--	---------------



DEKO-LIGHT R-DMX 3+1

RDM means »Remote Device Management«. This remote device management enables the control of the RDMX 3+1 from the control panel. This provides a great advantage, specifically for inaccessible installations or sites that are difficult to reach. If RDM is not available, the DMX address assignment can also be set manually via the DIP switch.

- complies with the DMX 512/1990, RDM protocol/2009
- supports automatic DMX addressing
- incl. top-hat rail adapter
- incl. 2m CAT5 cable [RJ45]
- flicker free
- connection: screw terminals
- dimensions L x W x H: 120 x 43 x 23 mm
- max. 4A each channel
- power: 4x 48W [192W] at 12V,
4x 96W [384W] at 24V

item	colour	price
843273	■ black	86,95 €



accessories

930697	Data cable RJ45 for connecting controller or further dimmers, length 2.0 m	3,95 €
---------------	--	---------------



DEKO-LIGHT LED DMX DIMMER 2

- simple and powerful 1-2 channel dimmer
- to be used as a single device or in connection with a control panel in an assembly
- flicker free
- connection: screw terminals
- control: DMX, 0-10V, manual, automatic
- dimensions L x W x H: 115 x 57 x 25 mm
- max. 6A each channel
- power: 2x 72W [144W] at 12V,
2x 144W [288W] at 24V



item	colour	price
843336	■ black	79,95 €



DEKO-LIGHT LED DMX DIMMER 4

- simple and powerful 4 channel dimmer
- to be used as a single device or in connection with a 4 channels DMX wall controller
- flicker free
- connection: screw terminals
- control: DMX, manual, automatic
- dimensions L x W x H: 115 x 57 x 25 mm
- max. 3A each channel
- power: 4x 36W [144W] at 12V,
4x 72W [288W] at 24V



item	colour	price
843337	■ black	86,95 €





DEKO-LIGHT POWER SUPPLY WITH INTEGRATED 3-CHANNEL DMX DIMMER

- compact DMX combi device for simple and quick installation
- powerful 3 channel dimmer and power supply combined in one housing
- controlled with all 3 channels DMX control panels
- supports DMX512
- dimmable from 0 - 100%
- soft dimming without flickering
- dimensions L x W x H: 196 x 75 x 40 mm
- power: 3x 45W



item	colour	Ausgangsspannung	power	price
843274	■ black	12V	135 W	169,95 €
843275	■ black	24V	135 W	169,95 €



accessories

930697	Data cable RJ45 for connecting controller or further dimmers, length 2.0 m	3,95 €
---------------	--	---------------



With the kind support of SH-Lichttechnik, Prüflingen und Becks Reutlingen



DEKO-LIGHT LED DMX/R-DMX DIMMER 4 CC

- controls 4 independent constant current [CC] LED-luminaires via all common DMX and RDM DMX controllers
- constant current for each channel individually adjustable from 200 - 1600 mA in 50 mA steps
- output voltage for CC-compatible luminaires: 1 - 42V
- all settings via a simple menu via OLED display
- flicker free
- short-circuit proof and overload protection
- connection: screw terminals
- dimensions L x W x H: 135 x 69 x 36 mm
- power: max. 4x 60W



item	colour	price
843054	■ black	119,95 €



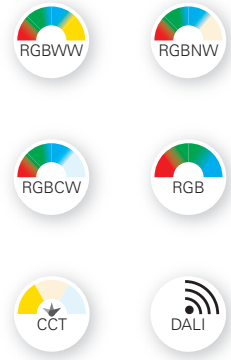

DEKO-LIGHT DALI MULTI LED PWM-DIMMER 1-4 CHANNEL

Innovative and adjustable multi-LED Dali dimmer that can be set to the individually required number of channels [1-4] by means of DIP switches. The highlight of the dimmer exclusively available at DEKO-LIGHT: it occupies only the set number of channels in the Dali bus and thus saves a lot of otherwise unnecessarily occupied system resources. The dimmer is suitable for 12V-48V Stripes and with a frequency of 2 kHz flicker-free and therefore also for the event technology in theaters, Stutdi etc. best suited.

- for controlling 1-4 channel LED stripes [single, WW/CW, RGB, RGBW components]
- required channel mode can be set individually by DIP switch
- dimmer occupies only set number of DALI channels
- controllable/dimmable via DALI 1 or DALI 2
- Device Type DT6
- flicker free [2 2 kHz]
- overload / short circuit indication / switch-off
- dimensions L x W x H: 180 x 52 x 20 mm
- power: 20A [max. 4x5 A]
4x 60W [240W] at 12V,
4x 120W [480W] at 24V,
4x 240W [960W] at 48V

item	colour	price
843070	<input type="checkbox"/> white	134,95 €

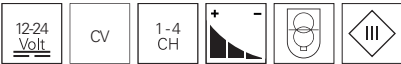

DEKO-LIGHT DALI LED PWM-DIMMER 1/2 CHANNEL

- for controlling 1-2 channel LED stripes [single, WW/CW components]
- dimmable via Dali Bus according to IEC 62386
- overload / short circuit indication / switch-off
- dimensions L x W x H: 167 x 51 x 23 mm
- max. 5A each channel
- power: 2x 120W [240W] at 12 V,
2x 240W [480W] at 24 V



item	colour	Typ	price
843051	<input type="checkbox"/> white	DT6 / 2 DALI addresses	109,95 €
843071	<input type="checkbox"/> white	DT8 / 1 DALI adresse	109,95 €



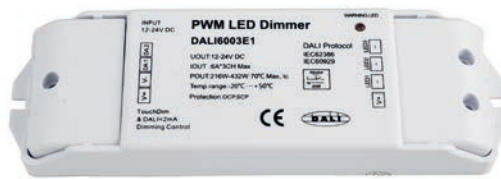

DEKO-LIGHT DALI LED PWM-DIMMER 3 CHANNEL

- for controlling 3 channel LED stripes [RGB components]
- dimmable via Dali Bus according to IEC 62386
- Device Type DT6
- overload / short circuit indication / switch-off
- dimensions L x W x H: 167 x 51 x 23 mm
- max. 6A each channel
- power: 3x 72W [216W] at 12V,
3x 144W [432W] at 24V

item	colour	price
843052	<input type="checkbox"/> white	114,95 €

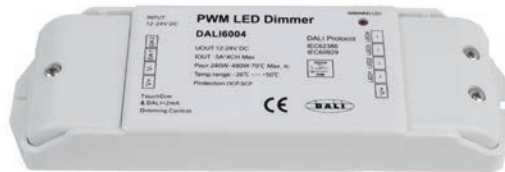

DEKO-LIGHT DALI LED PWM-DIMMER 4 CHANNEL

- for controlling 1-4 channel LED stripes [single, WW/CW, RGB, RGBW components]
- dimmable via Dali Bus according to IEC 62386
- Device Type DT6
- overload / short circuit indication / switch-off
- each channel L x W x H: 167 x 51 x 23 mm
- max. 5A each channel
- power: 4x 60W [240W] at 12V,
4x 120W [480W] at 24V

item	colour	price
843010	<input type="checkbox"/> white	129,95 €





ILLUMINANTS

- 798 G4 | G53 QR111
- 799 MR16/GU5,3
- 800 G9 | GU10
- 802 E14
- 803 E27
- 806 R7s | GX53



G4
page 798



G4
page 798



G53 QR111
page 798



MR16/GU5,3
page 799



MR16/GU5,3
page 799



G9
page 800



GU10
page 800



GU10
page 801



E14
page 802



E27
page 803



E27
page 803



E27
page 804



E27
page 804



E27
page 804



E27
page 805



E27
page 805



R7S
page 806



R7S
page 806



GX53
page 807



illuminants

OSRAM PARATHOM LED PIN G4

- plastic
- dimensions L x Ø: 36 x 13 mm



item	colour	colour temp.	light current	power	equivalent to	beam angle	EEL energy consumption	price
180213	<input checked="" type="checkbox"/> colourless	<input checked="" type="checkbox"/> 2700 K	200 lm	1,8 W	20 W	320°	F 2 kWh/1000h	8,95 €

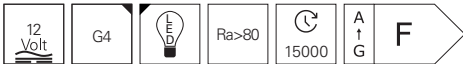

PHILIPS COREPRO LEDCAPSULE G4

- plastic
- dimensions L x Ø: 40 x 15 mm



item	colour	colour temp.	light current	power	equivalent to	beam angle	EEL energy consumption	price
180193	<input type="checkbox"/> silver	<input checked="" type="checkbox"/> 2700 K	315 lm	2,7 W	28 W	300°	F 3 kWh/1000h	19,95 €

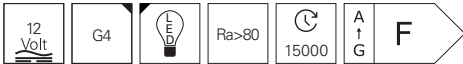

LEDVANCE LED AR111 DIMMABLE

- plastic
- dimensions L x Ø: 55 x 111 mm



item	colour	colour temp.	light current	power	equivalent to	beam angle	EEL energy consumption	price
180256	<input checked="" type="checkbox"/> grey	<input checked="" type="checkbox"/> 2700 K	450 lm	7,4 W	35 W	24°	G 8 kWh/1000h	39,95 €
180257	<input checked="" type="checkbox"/> grey	<input checked="" type="checkbox"/> 3000 K	450 lm	7,4 W	35 W	24°	G 8 kWh/1000h	39,95 €

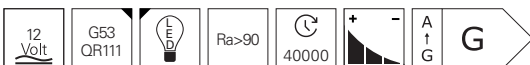



LEDVANCE LED MR16

- glass
- dimensions L x Ø: 46 x 51 mm

item	colour	colour temp.	light current	power	equivalent to	beam angle	EEL energy consumption	price
180254	<input checked="" type="checkbox"/> colourless	3000 K	210 lm	2,6 W	20 W	36°	F 3 kWh/1000h	9,95 €
180183	<input checked="" type="checkbox"/> colourless	4000 K	230 lm	2,6 W	20 W	36°	G 3 kWh/1000h	9,95 €
180177	<input checked="" type="checkbox"/> colourless	3000 K	350 lm	3,8 W	35 W	36°	F 5 kWh/1000h	12,95 €
180175	<input checked="" type="checkbox"/> colourless	4000 K	350 lm	3,8 W	35 W	36°	F 5 kWh/1000h	12,95 €

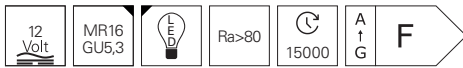

LEDVANCE LED MR16 DIMMABLE

- glass
- dimensions L x Ø: 44 x 50 mm

item	colour	colour temp.	light current	power	equivalent to	beam angle	EEL energy consumption	price
180263	<input checked="" type="checkbox"/> colourless	3000 K	230 lm	3,4 W	20 W	36°	G 4 kWh/1000h	13,95 €
180197	<input checked="" type="checkbox"/> colourless	4000 K	230 lm	3,4 W	20 W	36°	G 4 kWh/1000h	13,95 €
180255	<input checked="" type="checkbox"/> colourless	3000 K	345 lm	5,0 W	35 W	36°	G 5 kWh/1000h	14,95 €
180265	<input checked="" type="checkbox"/> colourless	4000 K	345 lm	5,0 W	35 W	36°	G 5 kWh/1000h	14,95 €
180266	<input checked="" type="checkbox"/> colourless	3000 K	621 lm	8,0 W	50 W	36°	G 9 kWh/1000h	19,95 €

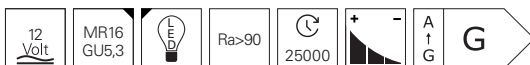

LEDVANCE LED P PIN G9

• plastic



item	colour	colour temp.	light current	power	equivalent to	beam angle	EEL	energy cons.	dimensions L x Ø	price
180267	colourless	2700 K	200 lm	1,9 W	20 W	360°	F	2 kWh/1000h	46 x 15 mm	7,95 €
180268	colourless	2700 K	320 lm	2,6 W	30 W	360°	E	3 kWh/1000h	47 x 15 mm	9,95 €
180269	colourless	2700 K	470 lm	4,2 W	40 W	360°	E	5 kWh/1000h	52 x 19 mm	12,95 €



LEDVANCE LED GU10

• glass
• dimensions L x Ø: 52 x 50 mm



item	colour	colour temp.	light current	power	equivalent to	beam angle	EEL	energy consumption	price
180275	silver	2700 K	350 lm	4,3 W	50 W	36°	F	5 kWh/1000h	7,95 €

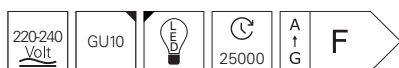

PHILIPS MASTER VALUE LED GU10 DIMMABLE

• glass
• dimensions L x Ø: 54 x 50 mm



item	colour	colour temp.	light current	power	equivalent to	beam angle	EEL	energy cons.	price
180209	silver	2700 K	270 lm	3,7 W	35 W	36°	F	4 kWh/1000h	13,95 €
180208	silver	2700 K	355 lm	4,8 W	50 W	36°	F	5 kWh/1000h	14,95 €
180049	silver	2700 K	355 lm	4,9 W	50 W	60°	F	5 kWh/1000h	14,95 €
180099	silver	3000 K	365 lm	4,9 W	50 W	36°	F	5 kWh/1000h	14,95 €
180050	silver	3000 K	365 lm	4,9 W	50 W	60°	F	5 kWh/1000h	14,95 €
180053	silver	4000 K	380 lm	4,9 W	50 W	36°	F	5 kWh/1000h	14,95 €
180051	silver	4000 K	380 lm	4,9 W	50 W	60°	F	5 kWh/1000h	14,95 €
180139	silver	3000 K	575 lm	6,2 W	80 W	36°	F	7 kWh/1000h	18,95 €
180149	silver	4000 K	575 lm	6,2 W	80 W	36°	F	7 kWh/1000h	18,95 €

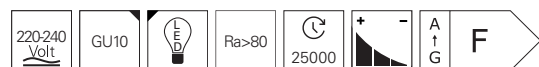

OSRAM PARATHOM LED GU10 DIMMABLE

- glass
- dimensions L x Ø: 52 x 50 mm



item	colour	colour temp.	light current	power	equivalent to	beam angle	EEL	energy cons.	price
180204	□ silver	ww 2700 K	575 lm	8,3 W	80 W	36°	G	9 kWh/1000h	14,95 €

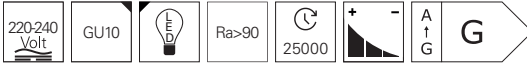

PHILIPS MASTER VALUE DT LED GU10 DIM-TO-WARM

- glass
- dimensions L x Ø: 54 x 50 mm
- dtw: dimming changes the colour temperature from 2700 to 2000 K



item	colour	colour temp.	light current	power	equivalent to	beam angle	EEL	energy consumption	price
180212	□ silver	dtw 2000-2700 K	270 lm	3,7 W	35 W	36°	F	4 kWh/1000h	14,95 €
180113	□ silver	dtw 2000-2700 K	355 lm	4,9 W	50 W	36°	F	5 kWh/1000h	16,95 €

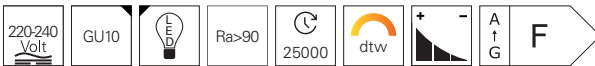

DEKO-LIGHT RF-SMART LED ILLUMINANT GU10 RGB+CCT RF CONTROLLABLE

- plastic
- dimensions L x Ø: 57 x 50 mm
- brightness and colour saturation dimmable
- 16 million colours and colour temperature adjustable
- 18 automatic programmes preinstalled
- programme and remote control synchronisation when operating several RF-smart lamps [repeater function]
- controllable with RF-smart radio remote controls [2.4GHz, range approx. 30m, not included in delivery]
- controllable with RF remote control only [no Zigbee functionality]



item	colour	colour temp.	light current	power	equivalent to	EEL	energy consumption	price
843515	□ white	rgb ww cw 2700-6000 K	300 lm	4 W	35 W	F	4 kWh/1000h	34,95 €



matching remote controls and further RF-smart components on page 763-773



PHILIPS COREPRO LEDCANDLE E14

- glass
- dimensions L x Ø: 97 x 35 mm

item	colour	colour temp.	light current	power	equivalent to	beam angle	EEl energy consumption	price
180238	<input type="checkbox"/> milky	<input checked="" type="checkbox"/> 2700 K	470 lm	4,3 W	40 W	360°	F 5 kWh/1000h	9,95 €

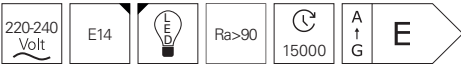

PHILIPS CLASSIC LEDCANDLE E14 DIM-TO-WARM

- glass
- dimensions L x Ø: 97 x 35 mm
- dtw: dimming changes the colour temperature from 2700 to 2000 K

item	colour	colour temp.	light current	power	equivalent to	beam angle	EEl energy consumption	price
180248	<input checked="" type="checkbox"/> colourless	<input checked="" type="checkbox"/> 2200-2700 K	470 lm	3,4 W	40 W	270°	D 4 kWh/1000h	13,95 €

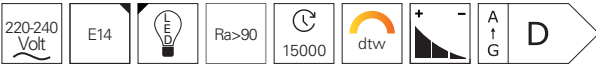



PHILIPS COREPRO LEDBULB E27 A60 DIMMABLE

- glass
- dimensions L x Ø: 104 x 60 mm

item	colour	colour temp.	light current	power	equivalent to	beam angle	EEL energy consumption	price
180214	<input type="checkbox"/> milky	<input checked="" type="checkbox"/> 2700 K	470 lm	3,4 W	40 W	150°	D 4 kWh/1000h	12,95 €

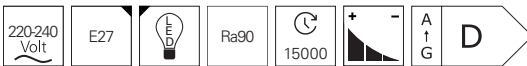

LEDVANCE LED RETROFIT E27 A60 DIMMABLE

- glass
- dimensions L x Ø: 105 x 60 mm

item	colour	colour temp.	light current	power	equivalent to	beam angle	EEL energy consumption	price
180253	<input checked="" type="checkbox"/> colourless	<input checked="" type="checkbox"/> 2700 K	806 lm	7,0 W	60 W	360°	E 7 kWh/1000h	8,95 €

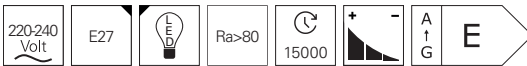

LEDVANCE LED CLASSIC E27 A75 DIMMABLE

- glass
- dimensions L x Ø: 105 x 60 mm

item	colour	colour temp.	light current	power	equivalent to	beam angle	EEL energy consumption	price
180277	<input type="checkbox"/> milky	<input checked="" type="checkbox"/> 2700 K	1055 lm	7,5 W	75 W	300°	D 8 kWh/1000h	12,95 €

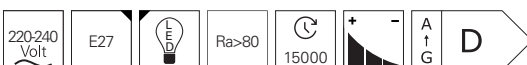



PHILIPS MASTER LEDSPOT E27 PAR 30 DIMMABLE

- glass
- dimensions L x Ø: 88 x 95 mm

item	colour	colour temp.	light current	power	equivalent to	beam angle	EEl energy consumption	price
180278	<input checked="" type="checkbox"/> colourless	ww 3000 K	760 lm	9,5 W	80 W	25°	F 10 kWh/1000h	42,95 €
180249	<input checked="" type="checkbox"/> colourless	nw 4000 K	820 lm	9,5 W	80 W	25°	F 10 kWh/1000h	42,95 €

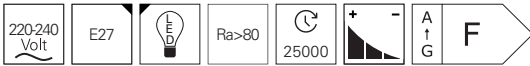

PHILIPS CLASSIC LEDLUSTER E27 P45 DIM-TO-WARM

- glass
- dimensions L x Ø: 78 x 45 mm
- dtw: dimming changes the colour temperature from 2700 to 2000 K

item	colour	colour temp.	light current	power	equivalent to	beam angle	EEl energy consumption	price
180279	<input checked="" type="checkbox"/> colourless	dtw 2200-2700 K	340 lm	2,5 W	25 W	270°	D 3 kWh/1000h	12,95 €
180245	<input checked="" type="checkbox"/> colourless	dtw 2200-2700 K	470 lm	3,5 W	40 W	270°	D 4 kWh/1000h	13,95 €

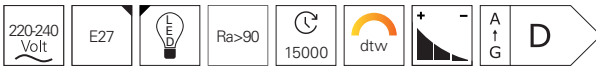

DEKO-LIGHT LED E27 RF RGBW MIT REMOTE CONTROL

- aluminium diecast
- dimensions L x Ø: 120 x 60 mm
- dimmable / colours adjustable via radio remote control
- not compatible/controllable with RF-smart system

item	colour	colour temp.	light current	power	equivalent to	EEl energy consumption	price
180136	<input type="checkbox"/> silver	RGB ww 3000 K	520 lm	8 W	60 W	G 8 kWh/1000h	49,95 €

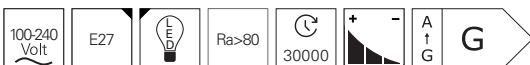



DEKO-LIGHT RF-SMART LED ILLUMINANT E27 RGB+CCT RF CONTROLLABLE

- plastic
- dimensions L x Ø: 100 x 57 mm
- brightness and colour saturation dimmable
- 16 million colours and colour temperature adjustable
- 18 automatic programmes preinstalled
- programme and remote control synchronisation when operating several RF-smart lamps [repeater function]
- controllable with RF-smart radio remote controls [2.4GHz, range approx. 30m, not included in delivery]
- controllable with RF remote control only [no Zigbee functionality]

item	colour	colour temp.	light current	power	equivalent to	beam angle	EEL energy consumption	price
843516	<input type="checkbox"/> white	2700-6000 K	550 lm	6 W	55 W	220°	F 6 kWh/1000h	34,95 €



matching remote controls and further RF-smart components on page 763-773



DEKO-LIGHT RF-SMART LED ILLUMINANT E27 MAX RGB+CCT RF CONTROLLABLE

- plastic
- dimensions L x Ø: 140 x 74 mm
- brightness and colour saturation dimmable
- 16 million colours and colour temperature adjustable
- 18 automatic programmes preinstalled
- programme and remote control synchronisation when operating several RF-smart lamps [repeater function]
- controllable with RF-smart radio remote controls [2.4GHz, range approx. 30m, not included in delivery]
- controllable with RF remote control only [no Zigbee functionality]

item	colour	colour temp.	light current	power	equivalent to	beam angle	EEL energy consumption	price
843517	<input type="checkbox"/> white	2700-6000 K	1100 lm	12 W	100 W	220°	F 12 kWh/1000h	64,95 €



matching remote controls and further RF-smart components on page 763-773



OSRAM HALOLINE R7S 78MM DIMMABLE

- glass
- dimensions L x Ø: 74,9 x 12 mm

item	colour	colour temp.	light current	power	beam angle	EEL	energy consumption	price
332269	<input checked="" type="checkbox"/> colourless	2800 K	750 lm	48W	360°	G	48 kWh/1000h	10,95 €
332270	<input checked="" type="checkbox"/> colourless	2950 K	1400 lm	80W	360°	G	80 kWh/1000h	10,95 €
332271	<input checked="" type="checkbox"/> colourless	2950 K	2250 lm	120W	360°	G	120 kWh/1000h	10,95 €

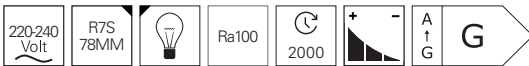

PHILIPS COREPRO LED R7S 118MM DIMMABLE

- plastic
- dimensions L x Ø: 118 x 29 mm

item	colour	colour temp.	light current	power	equivalent to	beam angle	EEL energy consumption	price
180097	<input type="checkbox"/> silver	3000 K	1600 lm	14W	100 W	360°	E 14 kWh/1000h	45,95 €

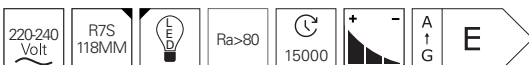



ISOLED LED GX53

- plastic
- dimensions L x Ø: 28 x 75 mm

item	colour	colour temp.	light current	power	equivalent to	beam angle	EEL energy consumption	price
180196	<input type="checkbox"/> white	<input checked="" type="checkbox"/> 3000 K	500 lm	6W	35 W	120°	D 6 kWh/1000h	21,95 €
180195	<input type="checkbox"/> white	<input checked="" type="checkbox"/> 4000 K	525 lm	6W	35 W	120°	D 6 kWh/1000h	21,95 €

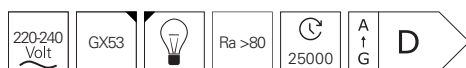



ACCESSORIES

- 812 indoor | dimming and switching
- 813 indoor | other
- 814 indoor | low voltage
- 815 indoor | low voltage | plug-in connector
- 817 outdoor | low voltage DC | WEIPU HQ plug-in connector
- 820 indoor | DMX cable
- 823 indoor | high voltage
- 824 indoor | high voltage | plug systems
- 825 outdoor | high voltage | plug systems
- 827 outdoor | cable connectors
- 830 indoor / outdoor | mounting material for LED stripes and profiles
- 831 outdoor | mounting accessories
- 837 indoor / outdoor | chemical products



□
indoor
dimming
from page 812



□
indoor
other
page 813



□
indoor
low voltage
page 814



□
indoor
low voltage
plug-in connector
from page 815



□
outdoor
low voltage DC
WEIPU HQ plug-in connector
from page 817



□
indoor / outdoor
DMX cable
page 820



□
indoor
high voltage
cable connectors
from page 823



□
indoor
high voltage
plug systems
page 824



□
outdoor
high voltage
plug systems
page 825



□
outdoor
cable connectors
from page 827

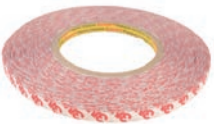

□
indoor / outdoor
mounting material for LED
stripes and profiles
page 830



□
outdoor
mounting accessories
page 831



□
indoor / outdoor
chemical products
from page 832



accessories

DIMMING VIA PHASE CONTROL/CUT-OFF

Please always ensure that the dimmer used is suitable for new installations and especially when retrofitting existing systems. You will find information on the housing as well as in the technical data sheets for which type of load, power and quantity of ballasts they are suitable.

types of electrical loads:

[R] = Ohmic load = light bulb, high-voltage halogen etc.
 [L] = Inductive load* = wound transformers
 [C] = Capacitive load* = high voltage LED, all electrical transformers

*Unless otherwise stated, max. 5 [C-load] or 2 [L-load] ballasts/lamps per dimmer.

DIMMER | PHASE CUT-OFF

suitable for dimming of:

- R loads [light sources] 10 - 350 W
- C loads [electrical ballasts] 10 - 350 W
- max. 5 electronic ballast
- adjustable minimum load / brightness
- perfectly matched to DEKO-LIGHT power supplies
- suitable for 68 mm flush-mounted / cavity wall sockets

item	colour	price
930060	<input type="checkbox"/> white	66,95 €

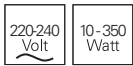

HIGH FREQUENCY MOTION SENSOR | MD1200

- angle of coverage 360°
- detection range 1 - 10 m
- switching time 5 sec - 30 min
- daylight threshold 5 - 2000 Lux
- suitable for switching all common illuminants / electronic ballast [R- / L- / C-loads]
- max. 5 electronic ballast
- dimensions L x W x H: 75 x 42 x 28 mm

item	colour	price
930036	<input type="checkbox"/> white	39,95 €



OVERVOLTAGE PROTECTION WITH CONTROL DISPLAY

Compact overvoltage protection that effectively prevents the premature failure of LED lights due to problems in power grids. For protection of 1-phase operated, non-dimmable LED lighting systems. Control LED to indicate correct operation. Depending on the connection there is the possibility of load circuit disconnection in case of a fault. IP67 design for direct installation in luminaires or upstream in junction boxes.

- plastic
- dimensions L x W x H: 37 x 30 x 20 mm

item	colour	price
843055	■ black	19,95 €

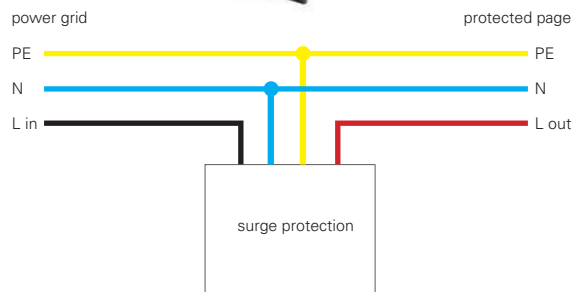
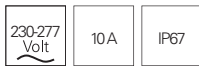

SAFETY SPACER

For the safe installation of downlights in ceilings with insulating material. Creates the required distance to the luminaire to ensure better air circulation. Please observe the installation instructions for the respective luminaire.

- for ceiling mounting rings from Ø 62 to 90 mm
- height 80 mm

item	colour	price
829063	■ black	5,95 €

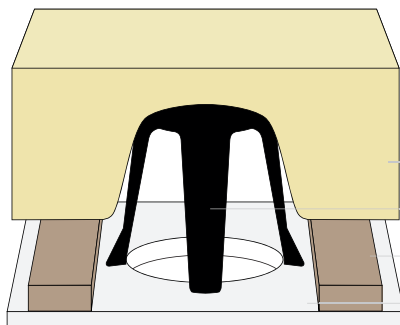

- glass wool
- safety spacer
- wood structure
- plasterboard





GU5,3 SOCKET

- ceramics
- thermo resistant connection cable

item	colour	connection cable	price
100200	<input type="checkbox"/> white	15 cm	0,95 €
100250	<input type="checkbox"/> white	50 cm	1,65 €



LOW VOLT SCREW DISTRIBUTOR SIX-WAY

- for fast cabling of up to 6 voltage-stable [CV] components on one power supply
- dimensions L x W: 63,5 x 26,0 mm
- 25 cm connection cable

item	colour	price
930006	<input type="checkbox"/> white	8,95 €



MINI-AMP CONNECTION CABLE | EXTENSION CABLE

- 2-pole version
- ready-to-plug-in installation of pre-assembled component
- simple and reverse polarity protected installation

item	colour	version	dimensions L	price
940032	<input type="checkbox"/> white	connection cable - plug	30 cm	2,95 €
940036	<input type="checkbox"/> white	connection cable - plug	100 cm	3,95 €
940040	<input type="checkbox"/> white	connection cable - plug	200 cm	4,95 €
940044	<input type="checkbox"/> white	extension - plug/socket	50 cm	5,95 €
940048	<input type="checkbox"/> white	extension - plug/socket	100 cm	6,95 €
940052	<input type="checkbox"/> white	extension - plug/socket	200 cm	7,95 €

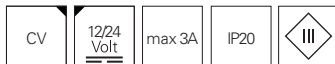

MINI-AMP MULTIPLE DISTRIBUTOR | PLUG - SOCKET

- 2-pole version
- ready-to-plug-in installation of pre-assembled component
- simple and reverse polarity protected installation

item	colour	version	connectings	price
940064	<input type="checkbox"/> white	three-way / 20 cm	1x plug, 3x socket	6,95 €
940065	<input type="checkbox"/> white	six-way / 20 cm	1x plug, 6x socket	7,95 €

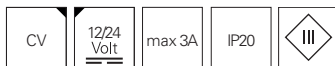

MINI-AMP INSERT SWITCH | PLUG - SOCKET

- 2-pole version
- ready-to-plug-in installation of pre-assembled component
- simple and reverse polarity protected installation

item	colour	dimensions L	price
940066	<input type="checkbox"/> white	2x 100 cm	12,95 €

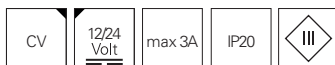

MINI-AMP ADAPTER MR16/GU5,3 | SOCKET - PLUG

- 2-pole version
- ready-to-plug-in installation of pre-assembled component
- easy mounting

item	colour	dimensions L	price
940067	<input type="checkbox"/> white	50 cm	4,95 €

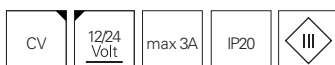





WEIPU HQ SOCKET / PLUG | 2-POLE

item	colour	version	price
940059	■ black	socket with screw cap	13,95 €
940060	■ black	plug	13,95 €
940058	■ black	socket special design	13,95 €

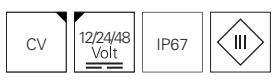

WEIPU HQ SOCKET / PLUG | 4-POLE

item	colour	version	price
940063	■ black	socket with screw cap	14,95 €
940062	■ black	plug	14,95 €
940061	■ black	socket special design	14,95 €

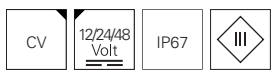

WEIPU HQ SOCKET / PLUG | 5-POLE

item	colour	version	price
940056	■ black	socket with screw cap	15,95 €
940057	■ black	plug	15,95 €

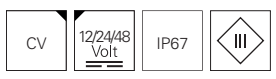

WEIPU CABLE

When planning and installing low-voltage DC systems, always pay attention to the cable lengths. A total length of 10 metres must not be exceeded. Excessive lengths can lead to voltage losses within the cables, e.g. to different colour renditions of RGB spotlights or visible brightness differences. Malfunctions such as flashing, flickering or flashing of the lamps can also occur. Furthermore, each radiator should be supplied with a separate connection cable if possible. Avoid installations with more than 3 radiators within one cable harness.

WEIPU HQ

Our new Weipu HQ cable series provides the highest quality cables and connectors, as well as higher cable crossections for even more reliability and durability for the power supply and operation of the corresponding spotlights.

WEIPU HQ SUPPLY CABLE | SOCKET 2-POLE

item	colour	dimensions L	price
940037	■ black	1 m	22,95 €
940038	■ black	3 m	22,95 €
940039	■ black	5 m	22,95 €



IP

WEIPU HQ SUPPLY CABLE | SOCKET 4-POLE

item	colour	dimensions L	price
940033	■ black	1 m	27,95 €
940034	■ black	3 m	42,95 €
940035	■ black	5 m	55,95 €



IP

WEIPU HQ SUPPLY CABLE | SOCKET | 5-POLE

item	colour	dimensions L	price
940029	■ black	1 m	31,95 €
940030	■ black	3 m	47,95 €
940031	■ black	5 m	59,95 €



IP

WEIPU HQ CONNECTION CABLE | 2-POLE

item	colour	dimensions L	price
940049	■ black	1 m	34,95 €
940050	■ black	3 m	42,95 €
940051	■ black	5 m	49,95 €



WEIPU HQ CONNECTION CABLE | 4-POLE

item	colour	dimensions L	price
940045	■ black	1 m	42,95 €
940046	■ black	3 m	56,95 €
940047	■ black	5 m	68,95 €



WEIPU HQ CONNECTION CABLE | 5-POLE

item	colour	dimensions L	price
940041	■ black	1 m	47,95 €
940042	■ black	3 m	60,95 €
940043	■ black	5 m	72,95 €



WEIPU JUNCTION BOX

- 2 outgoing plug sockets
- dimensions L x W x H: 57 x 57 x 38 mm

item	colour	Pole	connection cable	price
730300	■ black	2	30 cm	64,95 €
730301	■ black	4	30 cm	68,95 €
940010	■ black	5	100 cm	78,95 €





DMX-CONNECTION CABLE

- XLR-cable
- 3-pole plug / socket

item	colour	dimensions L	price
819066	■ black	1 m	9,95 €
819070	■ black	5 m	21,95 €
819072	■ black	10 m	34,95 €



DMX-CABLE ADAPTER | CAT5 AUF DMX XLR

item	colour	version	price
882271		DMX-plug to CAT5	54,95 €
882272		DMX-socket to CAT5	54,95 €



illustr. shows DMX-plug

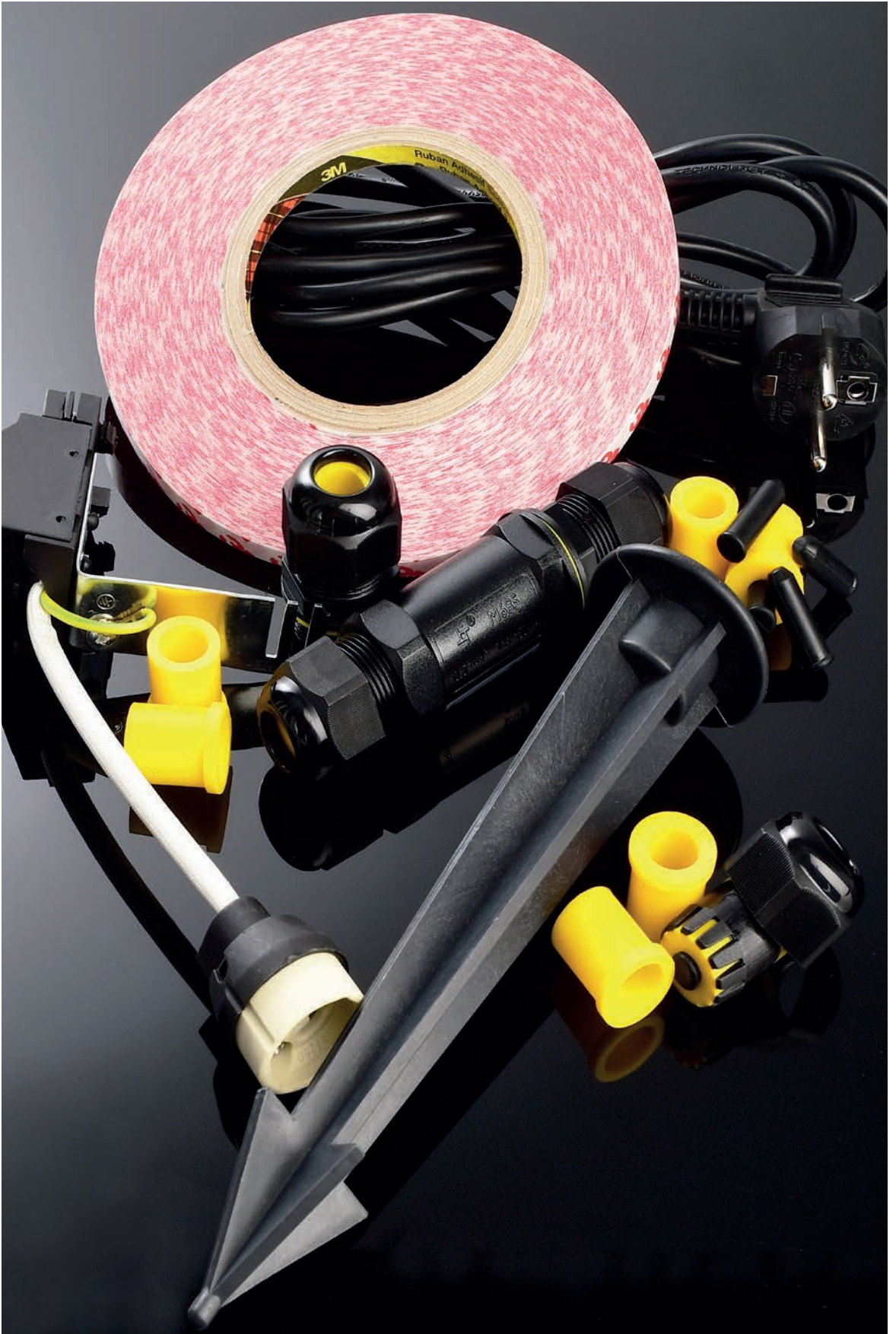

CERAMIC CLAMPS

- 2-pole, with fixing hole
- cable bis max. 2,5mm²
- dimensions L x W x H: 21 x 18 x 10 mm

item	colour	price
100301	<input type="checkbox"/> white	2,25 €

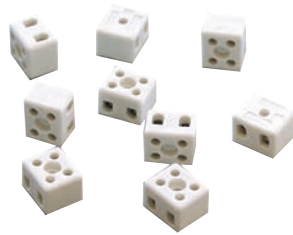

GU10 SOCKET

- ceramics
- 15 cm connection cable

item	colour	price
100202	<input type="checkbox"/> white	1,95 €



GU10 SOCKET

- spacer combined with junction box
- separate connection for protective conductor
- 10 cm cable

Essential: screw fitting mandatory for using with assembling frame between spacer VDE.

item	colour	price
100204	<input type="checkbox"/> white	3,95 €





CONNECTION CABLE WITH 230V MAINS PLUG

- plastic
- universally usable
- cable H07RN-F, 3x 1,5mm²
- open cable ends



item	colour	dimensions L	price
930587	■ black	2950 mm	19,95 €

220-240 Volt	max. 16 A	IP44
-----------------	--------------	------



DEKOLIGHT QUICK CONNECT BOX 2-WAY 230V

- plastic
- universally applicable for quick connection or wiring of power supply units or luminaires
- 3-pole plug-in terminals for rigid or flexible cables [e.g. NYM] from 0.5 to 1.5mm²
- 15cm pre-installed 3-core cable for connection to SKI/SKII power supplies/luminaires
- open cable ends
- quick release fastener secured with additional screw
- for insertion into ceilings with min. 68mm round cut-out and starting from a ceiling gap of 25mm

item	colour	dimensions L x W x H	price
930694	■ black	80 x 40 x 25 mm	5,95 €

220-240 Volt	max. 16 A	IP20
-----------------	--------------	------

WIELAND GST18i3 PLUG | SOCKET | DISTRIBUTOR BLOCK

• high voltage, 3-pole, for wire cross section 0,75 - 2,5 mm²

item	colour	version	price
800105	■ black	plug	8,95 €
800100	■ black	socket	8,95 €
800115	■ black	distributor block, 1 input, 5 outputs	27,95 €

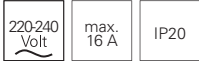

WIELAND GST18i3 SUPPLY CABLE WITH SCHUKO PLUG

• high voltage, 3-pole, for wire cross section 3 x 1,5 mm²

item	colour	dimensions L	price
800116	■ black	200 cm	19,95 €

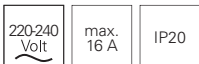

WIELAND GST18i3 SUPPLY CABLE WITH SOCKET | PLUG

• high voltage, 3-pole, for wire cross section 3 x 1,5 mm²

item	colour	version	dimensions L	price
800109	■ black	socket	100 cm	10,95 €
800111	■ black	socket	300 cm	16,95 €
800112	■ black	plug	100 cm	11,95 €
800114	■ black	plug	300 cm	16,95 €

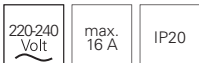

WIELAND GST18i3 EXTENSION LINE

• high voltage, 3-pole, for wire cross section 3 x 1,5 mm²

item	colour	dimensions L	price
800106	■ black	100 cm	16,95 €
800107	■ black	200 cm	18,95 €
800108	■ black	300 cm	22,95 €



WIELAND RST20i3 PLUG | SOCKET DISTRIBUTOR BLOCK | PROTECTIVE CAP

• high voltage, 3-pole, for wire cross section 1,5 mm² - 4,0 mm²

item	colour	version	price
800024	■ black	plug	16,95 €
800023	■ black	socket	16,95 €
800025	■ black	distributor block, 1 input, 3 outputs	27,95 €
800026	■ black	protective cap for plug	3,95 €
800027	■ black	protective cap for socket	3,95 €

220-240 Volt	max. 16 A	IP68
-----------------	--------------	------



IP

WIELAND RST20i3 SUPPLY CABLE WITH SCHUKO PLUG

• high voltage, 3-pole, for wire cross section 3 x 1,5 mm²
• mains plug IP44 / socket IP68

item	colour	dimensions L	price
800028	■ black	400 cm	69,95 €

220-240 Volt	max. 16 A	IP68
-----------------	--------------	------



IP

WIELAND RST20i3 SUPPLY CABLE

• high voltage, 3-pole
• with socket and open end
• cable type H07RN-F3
• G1/5 1,5 mm²

item	colour	dimensions L	price
800033	■ black	200 cm	29,95 €

220 Volt	max. 16 A	IP68
-------------	--------------	------



IP

WIELAND RST20i3 CONNECTION CABLE SOCKET | PLUG

• high voltage, 3-pole
• cable type H07RN-F3
• G1/5 1,5 mm²

item	colour	dimensions L	price
800029	■ black	200 cm	34,95 €
800036	■ black	400 cm	48,95 €

220 Volt	max. 16 A	IP68
-------------	--------------	------



IP

MULTI OUTDOOR CABLE DISTRIBUTORS

The more luminaires and accompanying lighting solutions are planned and project, the more complex the cable management becomes. A wide variety of cable and wire cross-sections come together and have to be connected as efficiently as possible. In outdoor areas, there are requirements added to protect cables against external influences. With the new, multifunctional cable connectors and distributors, you are perfectly equipped for these tasks.

All multi-outdoor cable distributors are supplied with the appropriate adapter sleeves in order to be able to insert different cable cross-sections, depending on the model.

waterproof cable glands

supplied blind plugs for unused cable entries
cable entries

access to cables via screwed, waterproof cover





OUTDOOR CABLE CONNECTORS GELBOX IPX8

- set consisting of 2 gel boxes
- silicone
- dimensions L x W x H: 38 x 30 x 26 mm
- suitable for 3 x 2,5mm² / 5 x 2,5mm²



item	colour	price
930402	 colourless	28,95 €



MULTI OUTDOOR CABLE CONNECTORS | CONNECTION SLEEVE

- waterproof cable glands M25
- for 2 cable 4-14 mm [adapter grommets included]
- for 2-5 cores 0,5-4 mm²
- L x W x H: 112,53 x 29,50 x 32,56 mm
- observe installation instructions



item	colour	price
930571	 black/yellow	9,95 €

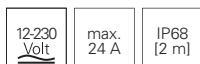

MULTI OUTDOOR Y-CABLE CONNECTORS | CONNECTION SLEEVE

- waterproof cable glands M25
- for 3 cable 4-14 mm [adapter grommets included]
- for 2-3 cores 0,5-4 mm²
- L x W x H: 139,71 x 71,88 x 32,56 mm
- observe installation instructions



item	colour	price
930573	 black/yellow	10,95 €

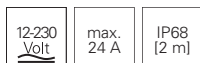

IP

MULTI OUTDOOR CABLE DISTRIBUTOR 2-FOLD

- waterproof cable glands M20
- for 2 cable 5-12 mm [adapter grommets included]
- for cores 0,5-2,5 mm²
- Ø x H: 65,33 x 46,31 mm
- cover: quick screw connection [screwless]
- observe installation instructions



item	colour	price
930578	■ black	6,95 €



MULTI OUTDOOR CABLE DISTRIBUTOR 2-FOLD

- waterproof cable glands M20
- for 2 cable 5-12 mm [adapter grommets included]
- for cores 0,5-2,5 mm²
- L x W x H: 138,20 x 42,77 x 35,70 mm
- cover verschraubt [screws included in delivery]
- observe installation instructions



item	colour	price
930712	■ black/yellow	9,95 €



IP

MULTI OUTDOOR CABLE DISTRIBUTOR 4-FOLD

- waterproof cable glands M25
- for 2-4 cable 4-14 mm [adapter grommets included]
- for cores 0,5-4,0 mm²
- L x W x H: 112,54 x 93,30 x 35,30 mm
- cover verschraubt [screws included in delivery]
- observe installation instructions



item	colour	price
930575	■ black/yellow	11,95 €



IP



MULTI OUTDOOR CABLE DISTRIBUTOR 4-FOLD

- waterproof cable glands M25
- for 2-4 cable 4-14 mm [adapter grommets included]
- for cores 0,5-4,0 mm²
- L x W x H: 170 x 155 x 65 mm
- cover verschraubt [screws included in delivery]
- observe installation instructions

item	colour	price
930735	black/yellow	19,95 € NEW

12-230 Volt	max. 24 A	IP68 [2 m]
----------------	--------------	---------------



Multi outdoor
Cable distributor
with integrated
230V RF-smart
Dimmer/Switch
page 764
843504



MULTI OUTDOOR STRAIGHT JOINT CAPSULE 4-FOLD

- spacious socket
- for 2-4 cable 6-14 mm
- for cores bis 2,5 mm²
- Ø x L: 70 x 190 mm
- FDM1: humic acid and corrosion resistant
- quick screw connection [screwless]
- incl. 8 cable ties 150,00 x 2,20 mm
- observe installation instructions

item	colour	price
730275	black/yellow	39,95 €

12-230 Volt	max. 24 A	IP68 [1 m]
----------------	--------------	---------------



MULTI OUTDOOR CABLE DISTRIBUTOR 10-FOLD

- waterproof cable glands M25
- for 2-10 cable 4-14 mm [adapter grommets included]
- for cores 0,5-4,0 mm²
- L x W x H: 182,95 x 135,30 x 49,10 mm
- cover verschraubt [screws included in delivery]
- observe installation instructions

item	colour	price
930574	black/yellow	39,95 €

12-230 Volt	max. 24 A	IP68 [2 m]
----------------	--------------	---------------



ASSEMBLY SET FOR IP65/IP67 LED-STRIPES

- set consists of:
15 silicone retaining clips
30 stainless steel screws
5 end caps
- delivery without silicone/adhesive

item	colour	for stripes with outer dimension	price
840392	<input checked="" type="checkbox"/> colourless	8-10 mm	4,95 € NEW
840293	<input checked="" type="checkbox"/> colourless	11-12 mm	4,95 €
840294	<input checked="" type="checkbox"/> colourless	13-15 mm	4,95 €
840295	<input checked="" type="checkbox"/> colourless	17-19 mm	4,95 €



end cap seal		
930104	natural stone sealant	39,95 €

3M™ DOUBLE-SIDED TAPE

- for mounting aluminium profiles or LED strips [not IP65/67 silicone strips] on smooth surfaces

item	colour	dimensions L x W x H	price
930345	<input type="checkbox"/> white	50000 x 08 x 0,20 mm	27,95 €
930346	<input type="checkbox"/> white	50000 x 10 x 0,20 mm	29,95 €
930347	<input type="checkbox"/> white	50000 x 12 x 0,20 mm	31,95 €
930348	<input type="checkbox"/> white	50000 x 15 x 0,20 mm	38,95 €
930349	<input type="checkbox"/> white	50000 x 20 x 0,20 mm	48,95 €
930350	<input type="checkbox"/> white	50000 x 25 x 0,20 mm	56,95 €

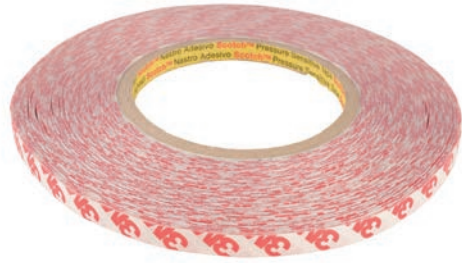

3M™ DOUBLE-SIDED TAPE FOR SILICONE SURFACES

- special adhesive tape for use on LED stripes in silicone hoses and silicone casting
- high solvent resistance
- high temperature resistance
- high initial liability
- high bond strength on most silicone surfaces and hard-to-stick substrate

item	colour	dimensions L x W x H	price
930405	<input type="checkbox"/> white	55000 x 10 x 0,127 mm	209,95 €
930406	<input type="checkbox"/> white	55000 x 12 x 0,127 mm	249,95 €



GROUND SPIKE IN CONNECTION WITH INSERT NUT

- plastic / metal
- for ground anchoring of surface-mounted luminaires in the ground

item	colour	Ø	dimensions L x Ø	price
700230	■ black	M5	200 x 50 mm	4,95 €
930426	■ black	M5	170 x 40 mm	9,95 €
700229	■ black	M6	160 x 43 mm	4,95 €
730349	■ black	M6	210 x 45 mm	6,95 €
930427	■ black	M10	219 x 45 mm	11,95 €



design example

WALL BRACKET / DISPLAYARM

- metal
- dimensions L: 80 cm
- carrying capacity max. 4,5 kg
- for mounting surface-mounted luminaires at a distance to the object / advertising sign
- optimal for the illumination of advertising signs on facades
- due to different applications delivery without mounting material

item	colour	price
930659	■ black	59,95 €



ISOLATING SPRAY

- spray can, 400 ml
- spray forms a flexible, UV-resistant protective coating for LED strips, connecting leads, electronic components and electrical connections

item	colour	price
930663	<input checked="" type="checkbox"/> colourless	45,95 €



GEL ADHESIVE FOR GLUING END CAPS

- cyanoacrylate instant adhesive
- tube 3g
- high initial adhesion
- very good adhesion to almost all substrates such as metals, steel, stainless steel, galvanised steel, aluminium, plastics [e.g. ABS, GRP, hard PC] or ceramic materials
- curing time: 8-12 Stunden
- observe safety and processing instructions

item	colour	price
930593	<input checked="" type="checkbox"/> colourless	5,95 €



MOUNTING GLUE

- bond+seal power
- cartridge, 310 ml
- highly resilient, elastic 1-component construction adhesive
- very good adhesion on almost all surfaces like e.g. metals, steel, stainless steel, galvanised steel, aluminium, plastics [e.g. ABS, GFK, rigid PVC] or ceramic materials
- UV-resistant
- approved according to NSF food law [NSF, P1 registered: 136996]
- high initial strength
- overpaintable with all commercial paint systems [except alkyd resin varnishes]

item	colour	price
930105	<input type="checkbox"/> white	35,95 €



NATURAL STONE SEALANT

- cartridge, 310 ml
- suitable for gluing profile covers and for use in wet rooms
- does not attack the surface of LEDs/strips
- permanently elastic
- high resistance to weathering, UV, ageing and colour
- excellently suited for heavy outdoor use

item	colour	price
930104	<input checked="" type="checkbox"/> colourless	39,95 €



SEALANT SMOOTHING AGENT

- spray can, 400 ml
- universally suitable for clean stripping for all types of sealants [e.g. silicones, polyurethane sealants etc.]
- easy processing from the aerosol can
- through uniform cross-linking of the surface the sealant joint hardens faster and the surface is improved

item	colour	price
930103	<input checked="" type="checkbox"/> colourless	39,95 €



**AT HOME EVERYWHERE – OUR LIGHTING SOLUTIONS
ARE AT HOME IN EVERY APPLICATION.
LET YOURSELF BE INSPIRED BY SELECTED PROJECT REFERENCES
FROM A WIDE VARIETY OF AREAS.**



With the kind support of Licht und Klein, Bergisch Gladbach



EXTERIOR

Whether free-standing luminaires, surface-mounted luminaires, underwater luminaires, recessed wall luminaires or wall washers - the outdoor area of a property, store or hotel should leave a lasting impression on visitors. Our example project shows a private house with an extensive outdoor area, which was staged with a great sense of noble elegance and lots of outdoor luminaires.



LIVING ROOM

Atmospheric light in living spaces is indispensable to create a harmonious ambience. With our extensive product portfolio, we cover everything from pendant luminaires to ceiling and furniture recessed luminaires to wall luminaires that you need to perfectly stage your four walls. Refine your premises with recessed wall luminaires and set professional lighting accents to create a cosy atmosphere for your living space.





LINEAR LIGHT

In order to emphasize and highlight design elements in architecture or even to deliberately arouse emotions through the interplay of light and shadow, linear light is increasingly becoming the focus of attention. The office building of an architectural firm is impressive proof of this. A modern, open building – stylishly illuminated with linear lighting solutions from DEKO-LIGHT.





Foto: Daniel Wieser - Architektur fotografie, Karlsruhe



Foto: Daniel Wieser - Architektur fotografie, Karlsruhe



Mit freundlicher Unterstützung von SH-Lichttechnik / Becks Reutlingen



HOTEL AND GASTRONOMY

Bars, restaurants and hotels only become a cozy place where guests like to come again and again with the right lighting. For this reason, the versatile lighting and profile portfolio of DEKO-LIGHT was used for the lighting design of the extensive restaurant areas.



STORE AND TRADE FAIR CONSTRUCTION

An individual and well thought-out lighting design not only enhances the visual value of a retail environment, but also has a sales-promoting effect. Flexibility is the key here, because the layout and displays of a store can change again and again. With our D LINE track systems and matching store fitting and display luminaires, you are ideally equipped to set the lighting stage for your sales areas.

With the kind support of WIBU-SYSTEMS AG, Karlsruhe



OFFICE AND BUSINESS PREMISES

A pleasant atmosphere at work not only boosts the mood of employees, but also their motivation and productivity. For an ultra-modern new company building in Karlsruhe, only luminaires and lighting technology from DEKO-LIGHT are used in an area of over 16,000 m² – from recessed ceiling luminaires in the corridors to custom solutions in the foyer area.

With the kind support of WIBU-SYSTEMS AG, Karlsruhe







COMMERCIAL

Commercial spaces are highly functional and place the highest demands on lighting efficiency. In our example project, the hall lighting for a BOSCH car service provider was implemented with TriProof LED surface-mounted ceiling luminaires, which with their IP65 protection class are convincing even in the adjacent car wash.



LIGHT COLOUR SELECTABLE

Luminaires with the designation "CCT Dip" allow you to change the light colour via a small dip switch [usually in the steps 3000K / 4000K / 5000K]. With their high application flexibility, CCT Dip luminaires offer customers who are still unsure about the light colour an enormous decision-making aid - and incidentally reduce your stock requirements.

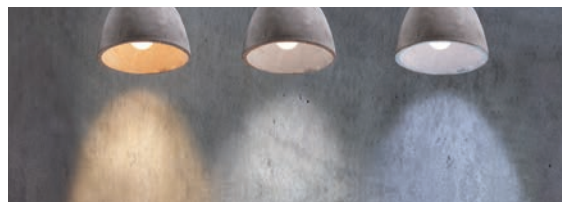

The colour temperature [light colour] is specified in Kelvin [K] and determines how the respective light is perceived.

WW = warm white light	2.300 K to 3.300 K [high red component]
NW = neutral white light	3.300 K to 5.300 K
CW = cool white / daylight white light	5.300 K to 8.000 K [high blue content]

The following guide values apply as orientation for different rooms following guide values apply:

living and sleeping are	WW
kitchen and bathroom	WW NW
offices	NW
industry	NW CW
photo studio / architectural lighting	CW



COLOUR RENDERING INDEX RA

The colour rendering index Ra is the measure of the correspondence of the perceived light colour between an existing lighting situation and a reference light source. The smaller the deviation, the better the colour rendition.

A light source with Ra 100 reproduces all colours exactly. The lower the Ra value, the less precisely the colours are reproduced.

Standard values:	
Incandescent bulb, halogen lamps	up to Ra 100
LED lamps	Ra 75-95
Compact fluorescent and energy-saving lamps	Ra 80-89
Fluorescent lamps	Ra 70-85



RA 70-80 medium colour rendition



RA 80-90 good colour rendition



RA 90-100 very good colour rendition



HCL

HCL stands for "Human Centric Lighting" and means the simulation of lighting situations according to the biological day-night rhythm of humans. HCL matches artificial light indoors to natural daylight and promotes well-being, mood and health. Numerous DEKO-LIGHT luminaires can already be integrated into an HCL control system to adjust the light colours to the biorhythm. In addition, several LED stripes in different light colours can be combined in one profile and thus integrated into the HCL lighting design.

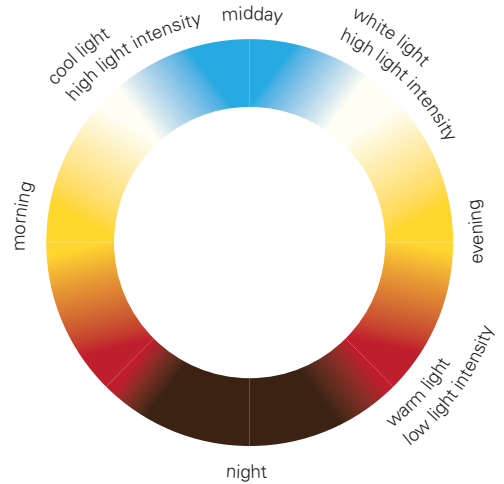

UGR VALUE

The smaller the UGR value, the more glare-free a luminaire emits its light. Especially in office areas, luminaires with a UGR value of less than 19 should be used to avoid disturbing reflections. When determining the UGR value of a complete room, additional factors such as wall colour[s] and surface finishes play a role.



DIM TO WARM

With the dim-to-warm function, you not only adjust the luminous intensity downwards, but by simultaneously changing the light colour [e.g. from 3000 to 2000 K], you obtain a room mood adapted to the new situation. LED luminaires with dim-to-warm technology can therefore be used particularly flexibly.

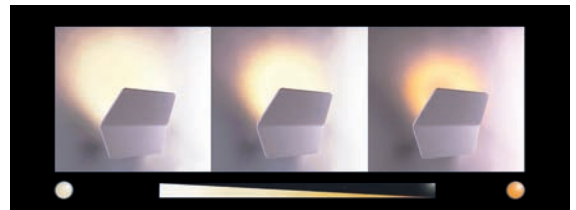

DALI DIMMABLE

Luminaires that can be dimmed via DALI can be perfectly integrated into lighting/property management systems. The great advantage lies in the wiring: via DALI, all luminaires in a line can be individually addressed and controlled. But this variant is also suitable for individual luminaires: DALI dimmers without an address exist for this purpose, which address the power supply unit directly. The good news: most systems on the market already have DALI interfaces.

WHAT IS HOW BRIGHT?

How many lumens do different lamps shine with?

candle	~ 12 lm
100W incandescent bulb	~ 1.340 lm
40W fluorescent lamp	~ 3.000 lm

HOW MANY LUMENS CORRESPOND HOW MANY WATT?

Luminous efficacy is measured in lumens per watt [lm/W] and indicates how efficiently a lamp shines and how energy is converted into light.

guide values:	
incandescent bulb	approx 10 lm/W
halogen lamp	approx 20 lm/W
fluorescent lamp	approx 70-90 lm/W
LED lamp	approx 60-170 lm/W

WHERE DO I NEED HOW MANY LUMENS?

You should plan for these lumens per square metre, so that your home is optimally and comfortably illuminated:

guide values:	
living room	approx 140 lm/m ²
bedroom	approx 140 lm/m ²
children's room	approx 140 lm/m ²
hallway	approx 140 lm/m ²
study	approx 280 lm/m ²
kitchen	approx 280 lm/m ²
bathroom	approx 280 lm/m ²

WHAT DOES »LUX« MEAN?

Lux [lx] is the physical unit of the illuminance of a light source. This photometric quantity indicates how much luminous flux from a light source falls on a given surface.

Of course, the following values do not have to be achieved in the entire room.

guide values:	
bedroom	45 Lux
living room	77 Lux
bathroom	110 Lux
hallway	207 Lux
study/office	300 Lux [at desk: 500 Lux]



IK VALUE

In addition to the IP protection class, you should also keep an eye on the IK value of a luminaire, which is increasingly required within the scope of tenders and for installations in public spaces. The IK value [or IK impact resistance level] indicates how impact-resistant a luminaire or certain components are. IK00 offers no protection against external mechanical stress, IK10 or IK10+ means that the luminaire can withstand a 5 or 10 kg test weight from a distance of 40 or 50 cm.

There are eleven codes, corresponding to the impact energy that an enclosure can withstand. [source: wikipedia.org]

Code	impact energy in joules	corresponds to drop height in mass
IK00	no protection	
IK01	0,14	7 cm - 200 g
IK02	0,20	8 cm - 250 g
IK03	0,35	14 cm - 250 g
IK04	0,50	20 cm - 250 g
IK05	0,70	28 cm - 250 g
IK06	1,0	40 cm - 250 g
IK07	2,0	40 cm - 500 g
IK08	5,0	25 cm - 2000 g
IK09	10,0	20 cm - 5000 g
IK10	20,0	40 cm - 5000 g
IK10+	50,0	50 cm - 10000 g

WHAT IS THE »AVERAGE RATED LIFE« OF AN LED?

The average rated service life of LEDs covers the period from the first time they are switched on until the time when only 50 percent of the LEDs tested are still functioning properly.

A specified service life of 30,000 hours for an LED stripe therefore means that after this period, on average, half of all stripes will have failed.

WHAT DOES »BINNING« MEAN?

Binning guarantees a constant quality of light with the same brightness level and uniform light colour. For this purpose the LEDs of a production batch are sorted and divided into so-called »bins«.

NORM TABLE

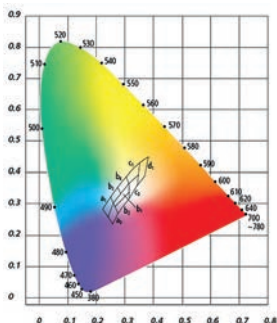

BINNINGS

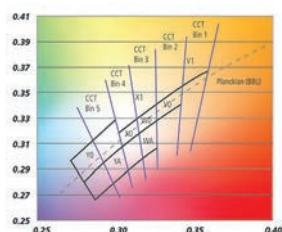

WHITE LEDs

With the kind support of Licht von Klein / www.licht-von-klein.de



IP PROTECTION ZONES

ZONE 3 | IP23

Outside zones 0 to 2, no special IP protection is necessary, provided no cleaning with direct water irradiation takes place.

ZONE 2 | IP44

In the areas 60 cm from zone 1, IP X4 protection applies.

ZONE 1 | IP65

In the wall area of the shower as well as in the tile area exposed to IP X5 is specified for the wall area of the shower and in the tile area exposed to splash water [max. 50 V].

ZONE 0 | IP67

In bathtubs and shower trays, low-voltage [max. 12 V] is absolutely required. The minimum IP protection is IP X7 [protected against water penetration].

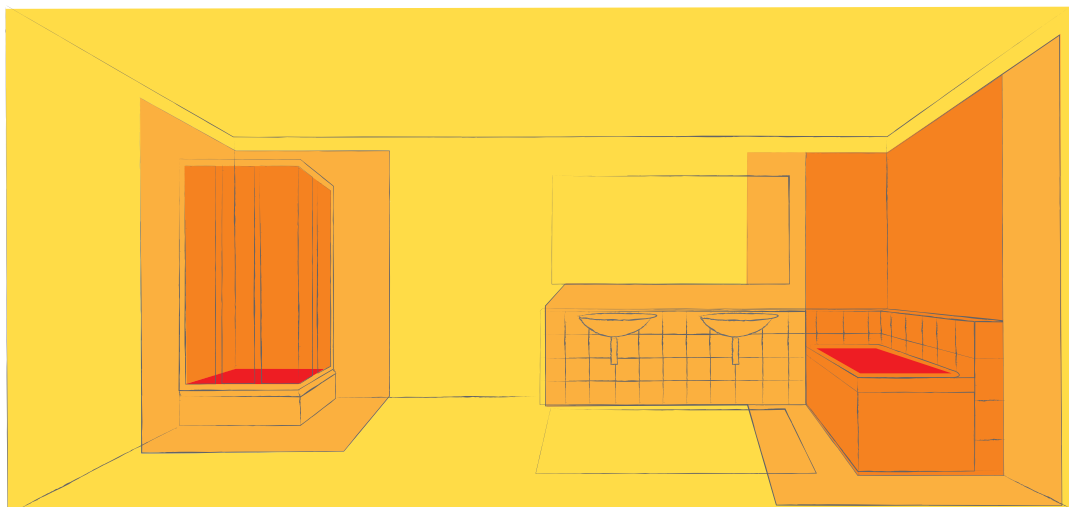
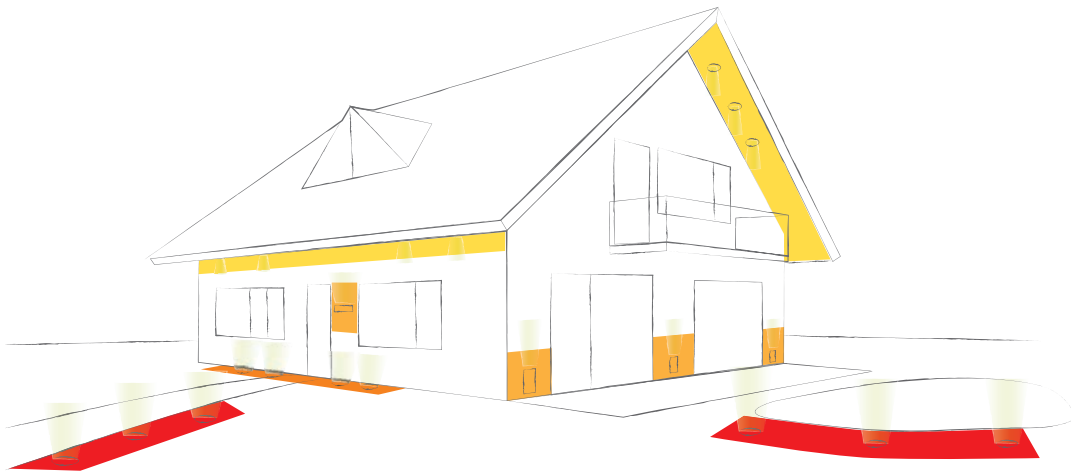

PROTECTION TYPES AND INSULATION CLASSES

Luminaires and other electrical appliances have a housing that protects live parts from contact, moisture or other environmental influences. This protection depends on the respective area of application. In order to have an overview of the suitable application, all devices are assigned to a classified protection type and an insulation class.

IP67

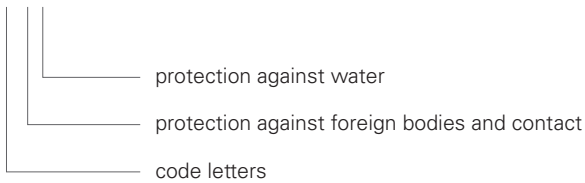

1. digit	protection against foreign bodies and contact	2. digit	protection against water
0	no protection	0	no protection
1	large foreign bodies [Ø > 50 mm] large body parts [e.g. back of the hand]	1	protection against vertically falling dripping water
2	medium-sized foreign bodies [Ø > 12 mm] finger	2	protection against dripping water falling at an angle [up to 15°]
3	small foreign bodies [Ø > 2,5 mm] tools and wires [Ø > 2,5 mm]	3	protection against water spray up to 60° from vertical
4	granular foreign bodies [Ø > 1 mm] tools and wires [Ø > 1 mm]	4	protection against splashing water on all sides
5	dust deposit complete protection against accidental contact	5	protection against jet water
6	dust entry complete protection against accidental contact	6	protection against jet water
		7	protection against temporary immersion
		8	protection against permanent immersion

ELECTRIC CHARACTERISTICS

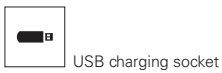
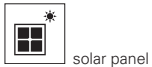
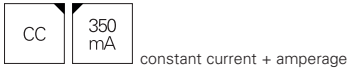
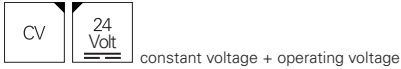
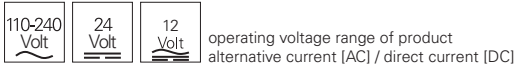

LAMP

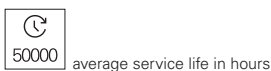
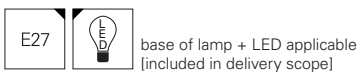
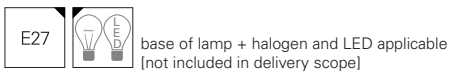
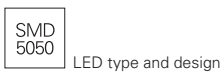
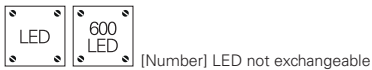
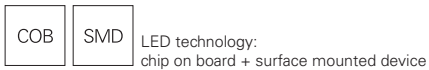

FUNCTIONALITY

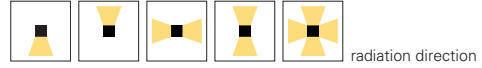
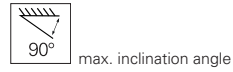
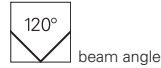

MOUNTING

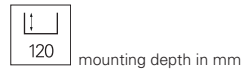
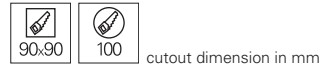

SURFACE

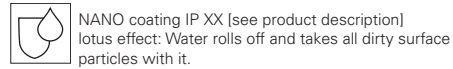

CONTROL



dim to warm function



radio frequency control



Bluetooth control



WiFi control



movement sensor [IR / HF]



DMX control



signal cable



dimmable



number of channels

SAFETY



IP protection class



IK value



walkable



passable



safety lamp control gear



components may be installed on fixtures of materials,
the fire behavior of which is not always known.



max. surface temperature
of lamp control gear



protection class I



protection class II
[protective isolation]



protection class III
[protective low voltage]



no cool beam
In lamps identified as such,
no cold light mirror lamps may be installed.

0							
000097	757	100202	822	180193	798	341198	174
000099	757	100204	822	180195	805	341200	178
000103	757	100250	814	180196	805	341201	178
000104	757	100301	822	180197	799	341202	178
000106	757	110000	100	180204	801	341203	178
000107	757	110001	100	180208	800	341207	176
000109	757	110002	100	180209	800	341208	176
000110	757	110003	101	180212	801	341209	177
000111	757	110004	101	180213	798	341210	177
000140	757	110007	101	180214	803	341215	171
000141	757	110010	102	180238	802	341216	170
000142	757	110017	103	180245	804	341217	170
001621	353	110018	103	180248	802	341223	183
001621	353	110019	103	180249	804	341225	182
001623	353	110020	103	180253	803	341228	195
		110027	99	180254	799	341229	195
		110028	99	180254	799	341232	171
		110029	99	180255	799	341236	193
1		110030	99	180256	798	341237	193
100032	164	110032	96	180257	798	341242	193
100078	162	110033	96	180263	799	341243	193
100079	162	110034	96	180265	800	341244	410
100084	157	110035	96	180266	800	341245	410
100088	157	110036	96	180267	799	341248	184
100089	157	110037	96	180268	799	342024	33
100108	500	110100	104	180269	800	342049	42
100109	500	110101	104	180275	800	342050	42
100111	485	110222	97	180277	803	342051	42
100112	485	110421	105	180278	804	342052	42
100114	486	110427	105	180279	804	342053	42
100116	486	110500	106	180512	108, 116, 118, 120, 123, 131, 134, 137, 138, 745	342054	42
100122	157	110501	106	180513	139, 745	342089	233
100123	160	110503	106	180514	116, 137, 745	342090	233
100124	161	111821	105	180515	756	342091	233
100125	160	122416	78	180529	756	342092	233
100133	489	122417	78			342093	233
100138	160	122420	107			342094	233
100139	160	126070	107			342095	32
100140	154	126073	107	3		342096	32
100141	154	126074	107	332269	806	342101	34
100142	155	131005	462	332270	806	342102	34
100143	154	131006	462	332271	806	342103	34
100144	154	180049	800	341033	182	342104	34
100145	155	180050	800	341035	183	342114	41
100146	156	180051	800	341105	182	342115	41
100147	156	180053	800	341183	180	342116	39
100148	157	180097	806	341184	180	342117	39
100149	154	180099	800	341185	180	342128	33
100150	154	180113	801	341188	172	342129	25
100151	156	180136	804	341189	172	342130	25
100152	165	180139	800	341190	172	342131	25
100153	165	180149	800	341194	172	342132	25
100154	160	180175	799	341195	172	342133	25
100156	165	180177	799	341196	172	342134	25
100157	165	180183	799	341197	174	342135	25
100200	814						

342136.....	25	342213.....	29	346033.....	360	348123.....	76
342144.....	36	342214.....	29	346034.....	360	348124.....	72
342145.....	36	342215.....	31	346035.....	360	348125.....	72
342146.....	229	342216.....	31	346036.....	360	348127.....	77
342147.....	229	342217.....	30	346037.....	360	348128.....	81
342148.....	51	342218.....	30	346044.....	206	348138.....	263
342149.....	51	342219.....	235	346045.....	363	348139.....	263
342150.....	51	342220.....	235	346046.....	363	348140.....	270
342151.....	51	342221.....	235	346047.....	363	348141.....	67
342158.....	230	342228.....	247	346048.....	363	348142.....	67
342159.....	168	342229.....	247	346049.....	363	348143.....	67
342160.....	168	342230.....	247	346050.....	363	348144.....	67
342170.....	23	342231.....	249	346051.....	363	348145.....	67
342171.....	23	342232.....	249	346063.....	243	348146.....	67
342172.....	23	342233.....	249	346064.....	243	348147.....	91
342173.....	23	342234.....	52	346065.....	243	348151.....	271
342174.....	23	342235.....	52	346066.....	245	348152.....	270
342175.....	23	342236.....	52	346067.....	245	348153.....	83
342176.....	23	342237.....	29	346068.....	245	348154.....	83
342177.....	26	342238.....	29	346077.....	365	348155.....	84
342178.....	26	342239.....	31	346078.....	365	348156.....	84
342179.....	27	342240.....	31	346079.....	365	348157.....	84
342180.....	27	342241.....	30	346080.....	365	348158.....	84
342181.....	27	342242.....	30	346081.....	365	348159.....	85
342182.....	27	343016.....	241	346082.....	365	348160.....	85
342183.....	49	343020.....	204	346083.....	365	348161.....	87
342184.....	49	343021.....	204	346084.....	365	348162.....	87
342185.....	49	343022.....	239	348001.....	79	348163.....	88
342186.....	49	343025.....	198	348002.....	79	348164.....	88
342187.....	49	343026.....	198	348004.....	79	348165.....	88
342188.....	49	343028.....	200	348005.....	79	348166.....	88
342189.....	47	343029.....	200	348007.....	436	348167.....	89
342190.....	47	343030.....	237	348009.....	436	348168.....	89
342191.....	47	343031.....	206	348011.....	436	348175.....	72
342192.....	47	343032.....	237	348013.....	80	348176.....	77
342193.....	47	343034.....	237	348022.....	78	348177.....	76
342194.....	47	343035.....	237	348023.....	78	348178.....	75
342195.....	47	346003.....	204	348024.....	78	348179.....	72
342196.....	47	346004.....	204	348025.....	78	348180.....	63
342197.....	47	346009.....	368	348048.....	80	348181.....	63
342198.....	47	346011.....	367	348049.....	80	348182.....	63
342199.....	47	346012.....	367	348051.....	64	348183.....	63
342200.....	47	346013.....	367	348052.....	64	348184.....	63
342201.....	45	346014.....	367	348069.....	436	348185.....	63
342202.....	45	346015.....	198	348070.....	436	348186.....	61
342203.....	45	346016.....	198	348071.....	437	348187.....	61
342204.....	45	346022.....	363	348072.....	437	348188.....	61
342205.....	45	346025.....	360	348085.....	70	348189.....	61
342206.....	45	346026.....	203	348086.....	70	348190.....	61
342207.....	45	346027.....	203	348087.....	71	348191.....	61
342208.....	45	346028.....	203	348099.....	81	348192.....	61
342209.....	45	346029.....	203	348107.....	73	348193.....	61
342210.....	45	346030.....	203	348120.....	435	348194.....	61
342211.....	45	346031.....	203	348121.....	435	348195.....	61
342212.....	45	346032.....	360	348122.....	75	348196.....	61

348197.....	61	565068.....	108	565236.....	119	565366.....	113
348198.....	59	565070.....	108	565245.....	130	565367.....	136
348199.....	59	565071.....	108	565246.....	130	565368.....	136
348200.....	59	565082.....	116	565247.....	123	565369.....	136
348201.....	59	565083.....	116	565248.....	117	565370.....	136
348202.....	59	565084.....	116	565250.....	142	565371.....	127
348203.....	59	565085.....	116	565251.....	142	565372.....	127
348204.....	59	565088.....	116	565252.....	143	565373.....	127
348205.....	59	565089.....	116	565253.....	144	565374.....	127
348206.....	59	565090.....	116	565254.....	144	565375.....	127
348207.....	59	565091.....	116	565255.....	145	565376.....	127
348208.....	59	565094.....	116	565256.....	146	565377.....	127
348209.....	59	565095.....	116	565257.....	146	565378.....	127
348210.....	73	565096.....	116	565258.....	147	565379.....	127
348212.....	91	565097.....	116	565282.....	131	565380.....	127
348213.....	83	565102.....	117	565283.....	131	565381.....	127
348214.....	83	565103.....	117	565284.....	131	565382.....	127
348215.....	83	565108.....	120	565285.....	131	565383.....	127
348216.....	83	565109.....	120	565315.....	111	565384.....	127
348223.....	87	565110.....	120	565316.....	112	565385.....	132
348224.....	87	565111.....	120	565317.....	112	565386.....	132
348225.....	87	565118.....	137	565318.....	113	565387.....	132
348226.....	87	565152.....	137	565320.....	136	565388.....	129
348233.....	75	565153.....	137	565321.....	136	565389.....	129
348234.....	75	565154.....	137	565322.....	136	565390.....	129
348235.....	76	565155.....	137	565323.....	136	565391.....	129
348236.....	76	565156.....	137	565325.....	274	565392.....	129
		565157.....	137	565326.....	274	565393.....	129
4		565158.....	137	565327.....	114	565394.....	129
401003.....	69	565159.....	137	565328.....	115	565395.....	129
401004.....	69	565160.....	137	565329.....	115	565396.....	129
401005.....	69	565161.....	137	565332.....	113	565397.....	129
401006.....	69	565162.....	137	565335.....	131	565398.....	129
401007.....	69	565163.....	137	565336.....	131	565399.....	129
401008.....	69	565172.....	120	565337.....	132	565400.....	129
401011.....	267	565173.....	120	565338.....	132	565401.....	129
401012.....	267	565180.....	134	565339.....	132	565402.....	129
401013.....	267	565181.....	134	565342.....	139	565403.....	129
401014.....	267	565182.....	135	565343.....	138	565404.....	129
401015.....	267	565183.....	135	565344.....	139	565405.....	129
401016.....	267	565184.....	135	565351.....	139	565406.....	129
449200.....	97	565185.....	135	565352.....	140	565407.....	129
449201.....	97	565193.....	121	565353.....	140		
449202.....	97	565194.....	121	565354.....	139	6	
449210.....	98	565195.....	123	565355.....	127	620006.....	213
449211.....	98	565198.....	121	565356.....	127	620007.....	213
449212.....	98	565220.....	151	565357.....	127	620031.....	230
		565221.....	151	565358.....	127	620032.....	230
5		565229.....	118	565359.....	127	620033.....	57
561201.....	755	565230.....	118	565360.....	127	620034.....	57
561202.....	755	565231.....	118	565361.....	138	620035.....	57
563009.....	188	565232.....	118	565362.....	111	620036.....	57
565007.....	134	565233.....	119	565363.....	112	620037.....	57
565010.....	134	565234.....	119	565364.....	112	620038.....	57
565067.....	108	565235.....	119	565365.....	113	620039.....	57

620040	57	686880	96	707056	341	707134	331
620041	57	687062	210	707057	341	707135	331
620042	57	687064	210	707067	343	707136	331
620043	57	687070	210	707068	343	707137	331
620044	57	687071	210	707069	342	707138	331
620045	57	687072	210	707070	342	707139	331
620046	57	687073	210	707079	337	707140	331
620047	57	687074	211	707080	337	707141	335
620048	57	687075	211	707081	337	707142	335
620049	57	687076	211	707082	353	707143	335
620050	57	687077	211	707083	353	707144	335
620051	57	687078	211	707090	339	707145	335
620052	57	687079	211	707091	339	707146	335
620053	57	687096	212	707092	339	707147	336
620054	57	687099	213	707093	339	707148	336
620055	57	687117	210	707094	338	707149	336
620056	57	687118	210	707095	338	707150	336
620057	225	688008	517	707096	338	707151	336
620102	225	688020	516	707097	338	707152	336
620103	225	688021	516	707098	338	707153	336
620104	227	688025	217	707099	338	707154	336
620105	225	688026	217	707100	338	707155	297
620106	225	688027	217	707101	338	707156	297
620107	225	688028	217	707102	338	707161	351
620108	225	688029	218	707103	338	707162	351
620109	225	688030	218	707104	338	707163	296
620110	225	688031	218	707105	338	707164	296
620111	227	688033	218	707106	338	707165	294
620112	227	688034	218	707107	338	707166	294
620113	227	688035	218	707108	338	707167	294
620114	227	688036	218	707109	338	707168	294
620115	227	688037	218	707110	333	707175	295
620116	227	688038	220	707111	333	707176	295
620117	227	688039	220	707112	333	707177	295
620118	227	688040	220	707113	333	707178	295
620119	332	688041	220	707114	333	707183	347
620120	332	688042	220	707115	333	707184	347
620123	413	688043	220	707116	344	707185	298
620124	413	688044	220	707117	344	707186	298
620125	413	688045	220	707118	345	707187	299
620126	413			707119	345	707188	299
620127	413	7		707120	345	710000	309
620128	413	700229	831	707121	345	710001	309
620129	413	700230	831	707122	346	710002	309
620130	413	707036	340	707123	346	710003	309
620136	180	707037	340	707124	348	710004	309
620137	180	707038	340	707125	348	710005	309
620138	180	707039	340	707126	348	710006	309
620139	180	707040	341	707127	348	710007	309
620140	180	707041	341	707128	348	710008	309
686864	96	707042	341	707129	348	710009	311
686867	96	707043	341	707130	331	710010	311
686868	96	707044	352	707131	352	710011	311
686869	96	707054	340	707132	351	710012	311
686871	96	707055	340	707133	351	710013	311

710014.....	311	710077.....	317	720032.....	291	730439.....	483
710015.....	313	710078.....	319	720033.....	291	730447.....	482
710016.....	313	710079.....	317	720034.....	291	730449.....	497
710017.....	313	710081.....	320	720035.....	291	730450.....	266
710018.....	313	710082.....	321	720036.....	290	730454.....	495
710019.....	313	710083.....	321	720037.....	290	730455.....	266
710020.....	313	710084.....	319	730007.....	379	730459.....	484
710024.....	326	710085.....	319	730009.....	378	730468.....	483
710025.....	326	710086.....	319	730032.....	379	730469.....	483
710026.....	326	710087.....	319	730034.....	406	730470.....	480
710027.....	315	710088.....	319	730209.....	491	730474.....	478
710028.....	315	710089.....	311	730211.....	490	730475.....	478
710029.....	315	710090.....	312	730238.....	462	730476.....	478
710030.....	315	710091.....	314	730244.....	496	730477.....	478
710031.....	315	710092.....	316	730248.....	491	730478.....	479
710032.....	315	710093.....	315	730255.....	489	730479.....	479
710033.....	316	710094.....	320	730262.....	501	730480.....	502
710034.....	316	710095.....	320	730266.....	495	730481.....	502
710035.....	316	710096.....	320	730267.....	495	730482.....	502
710036.....	314	710097.....	324	730275.....	829	730483.....	261
710037.....	314	710098.....	324	730276.....	496	730484.....	261
710038.....	314	710099.....	324	730289.....	492	730485.....	261
710039.....	312	710103.....	317	730292.....	501	730486.....	261
710040.....	312	720000.....	284	730296.....	492	730487.....	261
710041.....	312	720001.....	284	730300.....	819	730488.....	261
710042.....	312	720002.....	284	730301.....	819	730489.....	261
710043.....	312	720003.....	284	730328.....	420	730490.....	261
710044.....	312	720004.....	284	730329.....	420	730491.....	261
710045.....	310	720005.....	284	730330.....	427	730492.....	398
710046.....	310	720006.....	285	730331.....	427	730493.....	398
710047.....	310	720007.....	285	730332.....	383	730494.....	398
710048.....	320	720008.....	285	730333.....	383	731005.....	404
710049.....	320	720009.....	285	730336.....	485	731006.....	404
710050.....	320	720010.....	286	730339.....	480	731007.....	404
710051.....	323	720011.....	286	730340.....	480	731008.....	405
710052.....	323	720012.....	287	730349.....	831	731009.....	405
710053.....	323	720013.....	287	730354.....	391	731010.....	405
710054.....	326	720014.....	287	730364.....	389	731011.....	405
710055.....	326	720015.....	287	730365.....	389	731014.....	424
710056.....	326	720016.....	288	730380.....	420	731015.....	421
710057.....	318	720017.....	288	730381.....	424	731016.....	417
710058.....	318	720018.....	288	730382.....	424	731019.....	421
710059.....	318	720019.....	288	730395.....	417	731020.....	421
710060.....	327	720020.....	288	730407.....	434	731021.....	419
710061.....	327	720021.....	288	730408.....	434	731024.....	421
710062.....	327	720022.....	288	730409.....	434	731025.....	421
710063.....	318	720023.....	288	730410.....	434	731026.....	421
710064.....	318	720024.....	288	730419.....	265	731029.....	421
710065.....	318	720025.....	288	730420.....	494	731030.....	421
710066.....	317	720026.....	288	730421.....	494	731031.....	407
710067.....	317	720027.....	288	730424.....	265	731033.....	428
710068.....	317	720028.....	289	730425.....	265	731052.....	434
710069.....	317	720029.....	289	730432.....	501	731053.....	434
710070.....	309	720030.....	289	730434.....	501	731059.....	406
710071.....	309	720031.....	289	730438.....	483	731060.....	427

731071.....	419	732123.....	468	733063.....	380	840124.....	678
731072.....	419	732124.....	469	733064.....	457	840142.....	685
731087.....	426	732125.....	470	733065.....	457	840144.....	699
731088.....	426	732126.....	463	733066.....	455	840147.....	694
731098.....	464	732127.....	468	733067.....	455	840158.....	675
731099.....	423	732128.....	469	733068.....	394	840159.....	675
731100.....	423	732129.....	470	733069.....	394	840164.....	673
731113.....	408	732134.....	467	733070.....	459	840165.....	673
731116.....	373	732136.....	471	733071.....	459	840166.....	673
731119.....	431	732137.....	471	733072.....	397	840167.....	673
731122.....	371	732138.....	255	733073.....	397	840172.....	673
731124.....	429	732139.....	255	763004.....	440	840175.....	676
731127.....	420	732140.....	255	763005.....	440	840178.....	676
731128.....	420	732141.....	255	763006.....	440	840179.....	676
731129.....	428	732142.....	255	763007.....	440	840180.....	676
731130.....	418	732143.....	498	763011.....	440	840186.....	679
731131.....	418	732147.....	506	763012.....	440	840187.....	679
731133.....	416	732148.....	506	763025.....	442	840192.....	677
731134.....	428	732149.....	506	763026.....	444	840193.....	677
731135.....	428	732150.....	506			840194.....	677
731136.....	428	732151.....	506	8		840210.....	676
731137.....	409	732152.....	506	800023.....	825	840236.....	699
731138.....	415	732153.....	506	800024.....	825	840239.....	701
731139.....	415	732154.....	506	800025.....	825	840254.....	693
731140.....	415	732155.....	506	800026.....	825	840256.....	695
731141.....	415	732156.....	252	800027.....	825	840267.....	676
731142.....	272	732157.....	253	800028.....	825	840276.....	693
731143.....	273	732158.....	252	800029.....	825	840283.....	712
731144.....	416	732159.....	253	800033.....	825	840285.....	703
732036.....	462	733004.....	390	800036.....	825	840286.....	707
732037.....	462	733006.....	391	800100.....	824	840287.....	713
732049.....	498	733008.....	391	800105.....	824	840288.....	705
732050.....	499	733012.....	378	800106.....	824	840289.....	709
732064.....	508	733018.....	383	800107.....	824	840290.....	715
732071.....	474	733028.....	378	800108.....	824	840291.....	675
732072.....	475	733037.....	393	800109.....	824	840293.....	830
732074.....	512	733038.....	393	800111.....	824	840294.....	830
732075.....	512	733039.....	393	800112.....	824	840295.....	830
732076.....	512	733040.....	385	800114.....	824	840296.....	665
732079.....	474	733041.....	385	800115.....	824	840304.....	665
732080.....	475	733042.....	385	800116.....	824	840308.....	700
732084.....	257	733043.....	386	819066.....	820	840309.....	700
732085.....	257	733044.....	386	819070.....	820	840317.....	683
732093.....	464	733045.....	386	819072.....	820	840318.....	683
732094.....	464	733046.....	373	829063.....	96, 97, 98, 99,	840319.....	683
732095.....	464	733047.....	388	100, 101, 102, 103, 104,		840320.....	681
732096.....	507	733048.....	388	105, 106, 107, 108, 120,		840321.....	666
732097.....	507	733049.....	371	121, 123, 130, 131, 813		840322.....	666
732098.....	507	733050.....	371	836011.....	448	840323.....	665
732102.....	507	733054.....	453	836014.....	448	840324.....	665
732104.....	467	733055.....	453	836930.....	448	840331.....	678
732105.....	508	733057.....	401	836931.....	448	840332.....	678
732108.....	468	733058.....	401	836958.....	448	840333.....	679
732109.....	469	733061.....	381	840097.....	687	840334.....	679
732110.....	470	733062.....	380	840122.....	678	840337.....	683

840338.....	683	843020.....	775, 776	862037.....	210, 211	862193.....	135, 160, 161,
840339.....	683	843021.....	775, 777	862038.....	210, 211		162, 751
840340.....	683	843037.....	779	862048.....	744	862194.....	160, 751
840349.....	690	843046.....	787	862049.....	142, 144, 146	862196.....	745
840350.....	689	843047.....	786	862074.....	210;211	862197.....	745
840351.....	695	843049.....	779	862093.....	729	862198.....	119, 135, 139,
840352.....	694	843050.....	779	862094.....	729		142, 144, 146, 151, 745
840353.....	700	843051.....	792	862121.....	729	862199.....	143, 145, 147,
840373.....	701	843052.....	793	862122.....	131, 164, 729		745
840374.....	669	843054.....	791	862123.....	729	862201.....	135, 745
840375.....	671	843055.....	813	862124.....	729	862202.....	116, 118, 120,
840376.....	711	843056.....	480, 482, 483,	862125.....	729		123, 131, 137, 747
840378.....	689		489, 492, 774	862126.....	729	862203.....	108, 116, 747
840379.....	690	843057.....	117, 121, 123,	862127.....	730	862204.....	118, 134, 137,
840386.....	717		164, 774	862128.....	743		138, 747
840387.....	717	843058.....	486, 496, 497,	862129.....	743	862205.....	747
840388.....	717		775	862130.....	744	862207.....	116, 119, 137,
840389.....	717	843059.....	117, 130, 131,	862132.....	134		142, 144, 146, 747
840390.....	717		165, 230, 474, 475, 497,	862133.....	745	862208.....	119, 135, 139,
840391.....	717		775	862136.....	747		143, 145, 147, 151, 747
840392.....	830	843064.....	774	862138.....	747	862209.....	135, 747
840393.....	684	843065.....	774, 776	862141.....	749	862210.....	747
840394.....	684	843066.....	775, 776	862157.....	140, 745	862211.....	747
840395.....	684	843067.....	775, 776	862160.....	735, 736	862212.....	743
840396.....	685	843070.....	792	862161.....	735, ;736	862220.....	733
840397.....	685	843071.....	792	862162.....	730	862221.....	733
840398.....	685	843273.....	788	862163.....	730	862222.....	733
840399.....	697	843274.....	739, 790	862164.....	230, 474, 475,	862223.....	137, 744
840400.....	697	843275.....	739, 790		730	862224.....	744
840401.....	684	843279.....	230, 788	862165.....	730	862225.....	744
840402.....	684	843336.....	789	862166.....	117, 121, 123,	862226.....	744
840403.....	684	843337.....	789		130, 164, 165, 730	862227.....	744
840404.....	685	843500.....	763	862167.....	730	862228.....	744
840405.....	685	843501.....	763	862168.....	117, 121, 730	862229.....	728
840406.....	685	843502.....	763	862172.....	729	862230.....	462, 467, 468,
840407.....	697	843503.....	764	862173.....	729		480, 482, 483, 489, 728
840408.....	697	843504.....	764	862174.....	753	862231.....	729
840409.....	681	843505.....	765	862175.....	154, 155, 156,	862232.....	212, 729
840410.....	681	843506.....	765		162, 753	862233.....	117, 121, 123,
840411.....	681	843507.....	766	862176.....	753		131, 729
840412.....	681	843508.....	767	862180.....	325	862234.....	117, 121, 130,
843000.....	230, 784	843509.....	767	862181.....	325		729
843001.....	783	843510.....	767	862182.....	325	862235.....	747
843003.....	784	843511.....	767	862183.....	325	862236.....	139, 747
843004.....	785	843512.....	768	862184.....	325	862237.....	142, 144, 146,
843005.....	782	843513.....	769	862185.....	325		747
843008.....	778	843514.....	769	862190.....	116, 118, 137,	862238.....	744
843010.....	230, 793	843515.....	770, 801		139, 751	862239.....	744
843011.....	778	843516.....	771, 805	862191.....	118, 119, 134,	862240.....	212, 733
843013.....	774, 775	843517.....	771, 805		137, 138, 142, 144, 146,	862241.....	733
843014.....	774	843518.....	510, 772		157, 751	862242.....	733
843015.....	774	843519.....	510, 772	862192.....	119, 135, 139,	862243.....	754
843016.....	775	843520.....	510, 772		140, 143, 145, 147, 151,	862244.....	154, 155, 156,
843017.....	775	843521.....	511, 773		154, 155, 156, 751		162, 754
843019.....	774, 776	861203.....	780, 782			862245.....	754

862246.....	752	872114.....	738	930104.....	645, 647, 649,	930311.....	341
862247.....	752	872115.....	738		651, 653	930312.....	341
862248.....	752	872116.....	731	930105.....	597, 599, 603,	930313.....	341
862249.....	738	872117.....	735		605, 607, 609, 611, 613,	930314.....	341
862250.....	738	872118.....	737		615, 619, 621	930315.....	341
862251.....	738	872119.....	731	930147.....	713	930316.....	341
862252.....	738	872120.....	735	930160.....	210	930317.....	341
862253.....	736	872121.....	737	930167.....	151	930318.....	341
862254.....	736	872122.....	731	930191.....	210	930320.....	341
862255.....	736	872123.....	735	930209.....	210	930321.....	341
862256.....	736	872124.....	737	930212.....	210	930322.....	341
862257.....	157, 748	872125.....	731	930213.....	210	930323.....	341
862258.....	160, 161, 748	872126.....	735	930214.....	210, 211	930324.....	341
862259.....	160, 748	872127.....	212, 728	930215.....	142, 144, 146	930326.....	75, 76, 299
862262.....	736	872128.....	728, 782, 783,	930216.....	142, 144, 146	930327.....	75, 76, 299
862263.....	736		784, 785	930217.....	143, 145, 147	930328.....	75, 76, 139,
862264.....	747	872131.....	743	930218.....	142, 144, 146		299
862265.....	729	872132.....	746	930219.....	142, 144, 145,	930329.....	75, 76, 139,
862266.....	749	872134.....	746		146		299
872011.....	734	872135.....	733	930220.....	143, 147	930330.....	75, 76, 299
872014.....	746	872136.....	733	930230.....	151	930331.....	75, 76, 139,
872026.....	743	872137.....	733	930242.....	210, 211		299
872045.....	732	872138.....	733	930243.....	210	930332.....	75, 76, 139,
872046.....	732	872142.....	733	930244.....	211		299
872065.....	743	872143.....	733	930245.....	211	930333.....	75, 76, 139,
872082.....	730	872628.....	120, 744	930247.....	211		299
872083.....	468, 469, 470,	872629.....	729	930248.....	211	930334.....	73, 171
	471, 480, 482, 483, 486,	872630.....	729	930249.....	211	930335.....	73, 171, 352
	489, 492, 496, 497, 730	872647.....	747	930250.....	211	930336.....	73, 138, 171
872084.....	730	872817.....	734	930251.....	211	930337.....	73, 138, 171,
872085.....	474, 475, 730	882271.....	786, 787, 820	930270.....	123		352
872086.....	730	882272.....	820	930271.....	123	930339.....	73, 138, 171,
872087.....	730			930293.....	257		352
872088.....	730	9		930295.....	257	930340.....	73, 138, 171,
872089.....	730	930006.....	814	930297.....	298, 340		352
872091.....	165, 730	930036.....	812	930298.....	298, 340	930341.....	73, 138, 171,
872093.....	730	930060.....	812	930299.....	298, 340		352
872094.....	470, 471, 730	930071.....	265, 266	930300.....	298, 340	930345.....	559, 545, 830
872097.....	731	930072.....	265, 266	930301.....	297, 298, 337,	930346.....	830
872098.....	731	930084.....	140		340	930347.....	561, 574, 830
872099.....	731	930085.....	140	930302.....	297, 298, 337,	930348.....	563, 565, 575,
872100.....	731	930087.....	140		340		577, 603, 605, 607, 830
872101.....	731	930088.....	140	930303.....	297, 298, 337,	930349.....	567, 579, 830
872102.....	731	930089.....	141		340	930350.....	569, 597, 599,
872103.....	731	930090.....	141	930305.....	298		611, 613, 615, 830
872104.....	731	930091.....	141	930306.....	73, 138, 171,	930363.....	341
872105.....	731	930092.....	141		298, 340, 352	930364.....	298, 340
872106.....	731	930093.....	141	930307.....	73, 138, 171,	930365.....	341
872107.....	731	930094.....	141		298, 340, 352	930366.....	297, 298, 337,
872108.....	731	930095.....	141	930308.....	73, 138, 171,		340
872109.....	738	930096.....	141		298, 340, 352	930371.....	73, 138, 171,
872110.....	738	930097.....	141	930309.....	73, 138, 171,		352
872111.....	738	930103.....	645, 647, 649,		298, 340, 352	930381.....	75, 76, 139,
872112.....	738		651, 653	930310.....	73, 138, 171,		299
872113.....	738				298, 340, 352	930382.....	77, 139

930386.....	333	930470.....	445	930574.....	829	930668.....	154, 155, 156, 157, 165
930387.....	333	930471.....	445	930575.....	828	930669.....	154, 155, 156, 157
930388.....	333	930472.....	445	930577.....	81, 332	930670.....	160, 161, 162, 164
930390.....	77, 139	930473.....	445	930578.....	828	930671.....	160, 161, 162
930391.....	77, 139	930474.....	445	930587.....	468, 469, 470, 471, 823	930672.....	160, 161
930392.....	77, 139	930475.....	445	930590.....	255	930673.....	160
930393.....	77	930476.....	445	930592.....	217, 218, 220	930674.....	154, 155, 156, 157, 160, 161
930394.....	77	930477.....	445	930593.....	703, 705, 707, 709, 711, 712, 713, 715, 717, 832	930675.....	160
930395.....	77, 139	930478.....	445	930594.....	217, 218, 220	930676.....	154, 155, 156, 157
930396.....	77, 139	930480.....	188	930611.....	360	930677.....	89, 346, 347
930397.....	77, 139	930481.....	189	930612.....	360	930678.....	89, 346, 347
930398.....	77, 139	930482.....	188	930613.....	360	930679.....	26, 83, 87, 294, 295, 344, 348
930399.....	77, 139	930483.....	188	930614.....	360	930680.....	27, 84, 88, 345, 349
930402.....	827	930484.....	188	930615.....	360	930681.....	27, 84, 88, 345, 349
930405.....	830	930485.....	188	930616.....	360	930682.....	85, 89, 346, 347
930406.....	830	930486.....	188	930617.....	360	930684.....	85, 89, 346, 347
930410.....	507	930487.....	188	930618.....	361	930685.....	252, 253, 255
930411.....	507	930488.....	188	930619.....	361	930686.....	255
930413.....	443	930489.....	188	930620.....	361	930687.....	255
930414.....	443	930490.....	188	930621.....	361	930688.....	160
930415.....	443	930491.....	188	930622.....	361	930689.....	717
930416.....	443	930492.....	188	930623.....	361	930690.....	717
930417.....	443	930493.....	188	930624.....	361	930691.....	717
930418.....	443	930494.....	189	930625.....	361	930692.....	717
930419.....	443	930495.....	189	930626.....	361	930693.....	717
930420.....	443	930496.....	189	930627.....	361	930694.....	823
930421.....	443	930497.....	189	930628.....	361	930697.....	783, 788, 790
930422.....	443	930498.....	189	930629.....	361	930709.....	45, 59
930423.....	443	930499.....	189	930630.....	361	930710.....	45, 59
930424.....	443	930500.....	189	930631.....	361	930711.....	45, 59
930426.....	467, 468, 831	930501.....	189	930632.....	270, 271	930712.....	828
930427.....	469, 470, 471, 831	930502.....	189	930633.....	270, 271	930713.....	261
930428.....	467	930503.....	189	930634.....	270, 271	930714.....	363
930430.....	467	930504.....	189	930641.....	252, 253, 255	930716.....	363
930431.....	468	930505.....	189	930642.....	255	930727.....	243, 245
930432.....	468	930512.....	676	930652.....	111	930728.....	243, 245
930434.....	469	930513.....	676	930653.....	112	930729.....	243, 245
930435.....	469	930514.....	677	930654.....	112	930731.....	398
930437.....	470	930515.....	677	930655.....	113	930732.....	365
930438.....	470	930516.....	694	930656.....	113	930734.....	365
930441.....	468	930517.....	699	930659.....	510, 511, 772, 773, 831	930735.....	829
930442.....	469, 470	930530.....	711, 712	930663.....	832	930736.....	681
930443.....	711, 712	930531.....	703, 707	930664.....	154, 156, 157, 165	930737.....	681
930444.....	711, 712	930532.....	713, 715	930665.....	154, 155, 156, 157, 160, 161, 162, 164, 165	930738.....	681
930445.....	703, 707	930533.....	705, 709	930666.....	154, 155, 156, 157, 160, 161, 162, 165	930739.....	681
930446.....	703, 707	930544.....	81, 332	930667.....	154, 156, 157, 165		
930447.....	715	930545.....	81, 332				
930448.....	705, 709	930546.....	81, 332				
930449.....	705, 709	930558.....	471				
930451.....	713, 715	930566.....	211				
930460.....	367	930567.....	471				
930461.....	445	930568.....	471				
930468.....	445	930569.....	471				
930469.....	445	930571.....	827				
		930573.....	827				

930740.....	681	940031.....	818	970061.....	566	970470.....	598
930741.....	681	940032.....	815	970063.....	566	970502.....	592
930742.....	252	940033.....	818	970065.....	566	970503.....	592
930743.....	252, 253	940034.....	818	970068.....	566	970520.....	594
930744.....	29, 30, 31, 296, 351	940035.....	818	970080.....	558	970522.....	594
930745.....	29, 30, 31, 296, 351	940036.....	815	970081.....	558	970523.....	594
930746.....	29, 30, 31, 296, 351	940037.....	818	970083.....	558	970550.....	610
930747.....	29, 30, 31, 296, 351	940038.....	818	970085.....	558	970551.....	610
930748.....	29, 30, 31, 296, 351	940039.....	818	970101.....	560	970560.....	612
930749.....	29, 30, 31, 296, 351	940040.....	815	970103.....	560	970561.....	612
930752.....	26, 87, 294, 295, 344, 348	940041.....	819	970105.....	560	970570.....	614
930753.....	26, 87, 294, 295, 344, 348	940042.....	819	970108.....	560	970571.....	614
930754.....	27, 88, 345, 349	940043.....	819	970120.....	562	970572.....	540
930755.....	27, 88, 345, 349	940044.....	815	970121.....	562	970573.....	540
930756.....	26, 83, 87, 294, 295, 344, 348	940045.....	819	970123.....	562	970574.....	540
930757.....	26, 83, 87, 294, 295, 344, 348	940046.....	819	970125.....	562	970575.....	540
930758.....	26, 83, 87, 294, 295, 344, 348	940047.....	819	970128.....	562	970578.....	544
930759.....	27, 84, 88, 345, 349	940048.....	815	970129.....	562	970579.....	544
930760.....	27, 84, 88, 345, 349	940049.....	819	970140.....	564	970580.....	544
930761.....	27, 84, 88, 345, 349	940050.....	819	970141.....	564	970581.....	544
930762.....	85, 89, 346, 347	940051.....	819	970143.....	564	970584.....	542
930763.....	85, 89, 346, 347	940052.....	815	970145.....	564	970585.....	542
930764.....	85, 89, 346, 347	940056.....	817	970147.....	564	970586.....	542
930765.....	298	940057.....	817	970148.....	564	970587.....	542
930767.....	298	940058.....	817	970160.....	566	970600.....	600
930768.....	298, 340	940059.....	817	970161.....	566	970601.....	600
930769.....	341	940060.....	817	970163.....	566	970602.....	600
930770.....	75, 76, 139, 299	940061.....	817	970165.....	566	970723.....	644
930771.....	75, 76, 139, 299	940062.....	817	970168.....	566	970724.....	644
930775.....	253	940063.....	817	970180.....	558	970741.....	648
930776.....	398	940064.....	815	970181.....	558	970762.....	621, 623, 653
940010.....	819	940065.....	815	970183.....	558	970764.....	649, 651
940029.....	818	940066.....	815	970185.....	558	970770.....	583
940030.....	818	940067.....	815	970201.....	568	975001.....	572
		948139.....	431	970202.....	568	975003.....	572
		970000.....	560	970231.....	584	975005.....	572
		970001.....	560	970261.....	582	975008.....	572
		970003.....	560	970262.....	582	975021.....	574
		970005.....	560	970280.....	588	975023.....	574
		970007.....	560	970281.....	588	975025.....	574
		970008.....	560	970284.....	588	975028.....	574
		970020.....	562	970285.....	588	975029.....	574
		970021.....	562	970301.....	602	975041.....	576
		970023.....	562	970303.....	602	975043.....	576
		970025.....	562	970305.....	602	975045.....	576
		970027.....	562	970308.....	602	975061.....	578
		970028.....	562	970401.....	606	975063.....	578
		970029.....	562	970403.....	606	975065.....	578
		970040.....	564	970404.....	606	975081.....	570
		970041.....	564	970431.....	604	975083.....	570
		970043.....	564	970433.....	604	975085.....	570
		970045.....	564	970434.....	604	975101.....	572
		970047.....	564	970437.....	604	975103.....	572
		970048.....	564	970438.....	604	975105.....	572
		970060.....	566	970460.....	596	975108.....	572

975121.....	574	978012.....	563	978252.....	619	978632.....	575
975123.....	574	978020.....	565	978260.....	621	978640.....	577
975125.....	574	978021.....	565	978261.....	621	978641.....	577
975128.....	574	978022.....	565	978270.....	623	978642.....	577
975129.....	574	978030.....	567	978271.....	623	978650.....	579
975141.....	576	978031.....	567	978291.....	585	978651.....	579
975143.....	576	978032.....	567	978301.....	587	978652.....	579
975145.....	576	978040.....	561	978311.....	583	978660.....	559
975148.....	576	978041.....	561	978341.....	609	978661.....	559
975161.....	578	978042.....	561	978351.....	569	978662.....	559
975163.....	578	978050.....	563	978361.....	569	978670.....	559
975165.....	578	978051.....	563	978370.....	611	978671.....	559
975168.....	578	978052.....	563	978380.....	613	978672.....	559
975181.....	570	978060.....	565	978390.....	615	978680.....	571
975183.....	570	978061.....	565	978500.....	561	978681.....	571
975185.....	570	978062.....	565	978501.....	561	978682.....	571
975231.....	586	978070.....	567	978502.....	561	978690.....	571
975331.....	626	978071.....	567	978510.....	563	978691.....	571
975334.....	626	978072.....	567	978511.....	563	978692.....	571
975341.....	634	978080.....	573	978512.....	563	978700.....	603
975344.....	634	978081.....	573	978520.....	565	978701.....	603
975351.....	638	978082.....	573	978521.....	565	978702.....	603
975353.....	638	978090.....	575	978522.....	565	978711.....	585
975360.....	630	978091.....	575	978530.....	567	978721.....	587
975361.....	630	978092.....	575	978531.....	567	979000.....	563
975365.....	630	978100.....	577	978532.....	567	979001.....	563
975371.....	636	978101.....	577	978540.....	561	979002.....	563
975375.....	636	978102.....	577	978541.....	561	979010.....	565
975381.....	640	978110.....	579	978542.....	561	979011.....	565
975385.....	640	978111.....	579	978550.....	563	979012.....	565
975390.....	632	978112.....	579	978551.....	563	979020.....	563
975391.....	632	978120.....	573	978552.....	563	979021.....	563
975394.....	632	978121.....	573	978560.....	565	979022.....	563
975395.....	632	978122.....	573	978561.....	565	979030.....	565
975411.....	608	978130.....	575	978562.....	565	979031.....	565
975412.....	608	978131.....	575	978570.....	567	979032.....	565
975471.....	620	978132.....	575	978571.....	567	979040.....	575
975475.....	620	978140.....	577	978572.....	567	979041.....	575
975476.....	620	978141.....	577	978580.....	573	979042.....	575
975483.....	622	978142.....	577	978581.....	573	979050.....	577
975485.....	622	978150.....	579	978582.....	573	979051.....	577
975486.....	622	978151.....	579	978590.....	575	979052.....	577
975491.....	618	978152.....	579	978591.....	575	979060.....	575
975495.....	618	978161.....	569	978592.....	575	979061.....	575
975496.....	618	978170.....	607	978600.....	577	979062.....	575
975501.....	624	978171.....	607	978601.....	577	979070.....	577
975723.....	646	978175.....	625	978602.....	577	979071.....	577
975724.....	646	978191.....	593	978610.....	579	979072.....	577
975741.....	650	978201.....	595	978611.....	579	979080.....	561
975781.....	652	978211.....	629	978612.....	579	979081.....	561
978000.....	561	978221.....	635	978620.....	573	979082.....	561
978001.....	561	978231.....	639	978621.....	573	979090.....	567
978002.....	561	978241.....	601	978622.....	573	979091.....	567
978010.....	563	978250.....	619	978630.....	575	979092.....	567
978011.....	563	978251.....	619	978631.....	575	979100.....	561

979101.....	561	979561.....	575	980010.....	563	983014.....	563, 575, 593,
979102.....	561	979562.....	575	980011.....	563		595, 601, 603, 607, 621,
979110.....	567	979570.....	577	980012.....	563		623
979111.....	567	979571.....	577	980020.....	589	983015.....	563, 575, 593,
979112.....	567	979572.....	577	980021.....	589		595, 601, 603, 607, 621,
979120.....	573	979580.....	561	980023.....	589		623
979121.....	573	979581.....	561	980040.....	575	983016.....	563, 575, 593,
979122.....	573	979582.....	561	980041.....	575		595, 601, 603, 607, 621,
979130.....	579	979590.....	567	980042.....	575		623
979131.....	579	979591.....	567	980060.....	575	983017.....	563, 575, 593,
979132.....	579	979592.....	567	980061.....	575		595, 601, 603, 607, 621,
979140.....	573	979600.....	561	980062.....	575		623
979141.....	573	979601.....	561	980501.....	635	983018.....	563, 575, 593,
979142.....	573	979602.....	561	980511.....	639		595, 601, 603, 607, 621,
979150.....	579	979610.....	567	980541.....	603		623
979151.....	579	979611.....	567	980550.....	611	983020.....	565, 577, 585,
979152.....	579	979612.....	567	980560.....	613		587, 609, 619, 631, 637,
979160.....	559	979620.....	573	980570.....	615		641
979161.....	559	979621.....	573	981001.....	645	983021.....	565, 577, 585,
979162.....	559	979622.....	573	981011.....	647		587, 609, 619, 631, 637,
979170.....	559	979630.....	579	981021.....	653		641
979171.....	559	979631.....	579	981031.....	649	983022.....	565, 577, 585,
979172.....	559	979632.....	579	981041.....	651		587, 609, 619, 631, 637,
979180.....	571	979640.....	573	983000.....	561, 573, 627,		641
979181.....	571	979641.....	573		633, 635, 639	983023.....	565, 577, 585,
979182.....	571	979642.....	573	983001.....	561, 573, 627,		587, 609, 619, 631, 637,
979190.....	571	979650.....	579		633, 635, 639		641
979191.....	571	979651.....	579	983002.....	561, 573, 627,	983024.....	565, 577, 585,
979192.....	571	979652.....	579		633, 635, 639		587, 609, 619, 631, 637,
979200.....	621	979660.....	559	983003.....	561, 573, 627,		641
979201.....	621	979661.....	559		633, 635, 639	983025.....	565, 577, 585,
979210.....	623	979662.....	559	983004.....	561, 573, 627,		587, 609, 619, 631, 637,
979211.....	623	979670.....	559		633, 635, 639		641
979221.....	585	979671.....	559	983005.....	561, 573, 627,	983026.....	565, 577, 585,
979231.....	587	979672.....	559		633, 635, 639		587, 609, 619, 631, 637,
979241.....	583	979680.....	571	983006.....	561, 573, 627,		641
979500.....	563	979681.....	571		633, 635, 639	983027.....	565, 577, 585,
979501.....	563	979682.....	571	983007.....	561, 573, 627,		587, 609, 619, 631, 637,
979502.....	563	979690.....	571		633, 635, 639		641
979510.....	565	979691.....	571	983008.....	561, 573, 627,	983028.....	565, 577, 585,
979511.....	565	979692.....	571		633, 635, 639		587, 609, 619, 631, 637,
979512.....	565	979700.....	621	983010.....	563, 575, 593,		641
979520.....	563	979701.....	621		595, 601, 603, 607, 621,	983030.....	567, 579, 599
979521.....	563	979710.....	623		623	983031.....	567, 579, 599
979522.....	563	979711.....	623	983011.....	563, 575, 593,	983032.....	567, 579, 599
979530.....	565	979721.....	585		595, 601, 603, 607, 621,	983033.....	567, 579, 599
979531.....	565	979731.....	587		623	983034.....	567, 579, 599
979532.....	565	979741.....	583	983012.....	563, 575, 593,	983035.....	567, 579, 599
979540.....	575	979751.....	605		595, 601, 603, 607, 621,	983036.....	567, 579, 599
979541.....	575	979760.....	611		623	983037.....	567, 579, 599
979542.....	575	979770.....	613	983013.....	563, 575, 593,	983038.....	567, 579, 599
979550.....	577	979780.....	615		595, 601, 603, 607, 621,	983040.....	569, 583, 597,
979551.....	577	980000.....	563		623		599
979552.....	577	980001.....	563			983041.....	569, 583, 597,
979560.....	575	980002.....	563				599

983044.....569, 583, 597, 599	983522.....565, 577, 585, 587, 609	984024.....565, 577, 585, 609, 631	984554.....559, 571
983045.....569, 583, 597, 599	983523.....565, 577, 585, 587, 609	984025.....565, 577, 585, 609, 631	984555.....559, 571
983046.....569, 583, 597, 599	983524.....565, 577, 585, 587, 609	984026.....565, 577, 585, 609, 631	984565.....605
983060.....563, 575, 593, 595, 601, 603, 607, 621, 623	983525.....565, 577, 585, 587, 609	984032.....567, 579, 599	984568.....605
983061.....563, 575, 593, 595, 601, 603, 607, 621, 623	983526.....565, 577, 585, 587, 609	984033.....567, 579, 599	984570.....611
983062.....563, 575, 593, 595, 601, 603, 607, 621, 623	983527.....565, 577, 585, 587, 609	984034.....567, 579, 599	984571.....611
983080.....593	983530.....567, 579, 599	984035.....567, 579, 599	984580.....613
983081.....593	983531.....567, 579, 599	984036.....567, 579, 599	984581.....613
983082.....593	983532.....567, 579, 599	984044.....569, 583, 597, 599	984590.....615
983090.....589	983533.....567, 579, 599	984045.....569, 583, 597, 599	984591.....615
983091.....589	983534.....567, 579, 599	984054.....559, 571	985010.....563, 575, 607
983100.....611	983535.....567, 579, 599	984055.....559, 571	985011.....563, 575, 607
983101.....611	983536.....567, 579, 599	984502.....561, 573	985016.....563, 575, 607
983110.....613	983539.....567, 579, 599	984503.....561, 573	985504.....635, 639
983111.....613	983550.....559, 571	984504.....561, 573	985505.....635, 639
983120.....615	983551.....559, 571	984505.....561, 573	985508.....635, 639
983121.....615	983554.....559, 571	984510.....563, 575, 607, 621, 623	985570.....611
983500.....561, 573	983555.....559, 571	984511.....563, 575, 607, 621, 623	985571.....611
983501.....561, 573	983556.....559, 571	984512.....563, 575, 607, 621, 623	985580.....613
983502.....561, 573	983560.....563, 575, 601, 603, 607	984513.....563, 575, 607, 621, 623	985581.....613
983503.....561, 573	983561.....563, 575, 601, 603, 607	984514.....563, 575, 607, 621, 623	985590.....615
983504.....561, 573	983562.....563, 575, 601, 603, 607	984515.....563, 575, 607, 621, 623	985591.....615
983505.....561, 573	984002.....561, 573, 633	984517.....563, 575, 607, 621, 623	985601.....625
983506.....561, 573	984003.....561, 573, 633	984518.....563, 575, 607, 621, 623	985605.....625
983510.....563, 575, 601, 603, 607	984004.....561, 573, 633	984522.....565, 577, 585, 587, 609	987002.....561, 574
983511.....563, 575, 601, 603, 607	984005.....561, 573, 633	984523.....565, 577, 585, 587, 609	987004.....563, 575
983512.....563, 575, 601, 603, 607	984010.....563, 575, 601, 607, 621, 623	984524.....565, 577, 585, 587, 609	987006.....565, 577, 609
983513.....563, 575, 601, 603, 607	984011.....563, 575, 601, 607, 621, 623	984525.....565, 577, 585, 587, 609	987008.....567, 579
983514.....563, 575, 601, 603, 607	984012.....563, 575, 601, 607, 621, 623	984526.....565, 577, 585, 587, 609	987010.....569
983515.....563, 575, 601, 603, 607	984013.....563, 575, 601, 607, 621, 623	984532.....567, 579, 599	987020.....585, 587, 615, 619, 621
983516.....563, 575, 601, 603, 607	984014.....563, 575, 601, 607, 621, 623	984533.....567, 579, 599	987025.....589
983517.....563, 575, 601, 603, 607	984015.....563, 575, 601, 607, 621, 623	984534.....567, 579, 599	987026.....589
983518.....563, 575, 601, 603, 607	984017.....563, 575, 601, 607, 621, 623	984535.....567, 579, 599	987027.....589
983520.....565, 577, 585, 587, 609	984018.....563, 575, 601, 607, 621, 623	984544.....569, 583, 597, 599	987040.....561, 587, 619, 621
983521.....565, 577, 585, 587, 609	984022.....565, 577, 585, 609, 631	984545.....569, 583, 597, 599	987060.....559, 585, 615
	984023.....565, 577, 585, 609, 631		987080.....561, 563, 565, 567, 569, 573, 575, 577, 579, 609

988095.....	541
988096.....	545
988097.....	545
988098.....	545
988099.....	545
988100.....	545
988101.....	545
988102.....	545
988103.....	545
988105.....	545
990109.....	653



Hersteller / manufacturer: DEKO-LIGHT Elektronik Vertriebs GmbH

flairlight®
Innovative lighting

PO Box 676,
Epsom
Surrey
KT17 9PL

(T) 01372 888455
(F) 01372 888215
(e) sales@flairlight.co.uk
(w) www.flairlight.co.uk